

## Description

The enhancement mode MOS is extremely high density cell and low on-resistance.

MOSFET Product Summary		
$V_{DS}(V)$	$R_{DS(on)}(\Omega)$	$I_D(A)$
-20	0.037 @ $V_{GS}=-4.5V$	-4

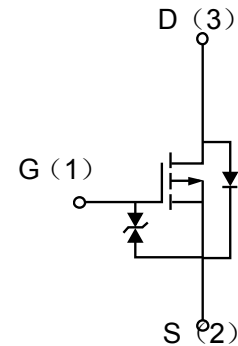

## Absolute maximum rating@25°C

Rating	Symbol	Value	Units
Drain-Source Voltage	$V_{DS}$	-20	V
Gate-Source Voltage	$V_{GS}$	$\pm 10$	V
Drain Current Continuous	$I_D$	-4	A
Pulsed Drain Current (Note 1)	$I_{DM}$	-30	A
Total Power Dissipation	$P_D$	1.4	W
Junction and Storage Temperature Range	$T_J, T_{STG}$	-55 to +150	°C

## Thermal resistance

Parameter	Symbol	Typ.	Units
Maximum Junction-to-Ambient (Note 2)	$R_{\theta JA}$	89.3	°C/W

Electrical characteristics per line @25°C ( unless otherwise specified)

Parameter	Symbol	Conditions	Min.	Typ.	Max.	Units
Drain-Source Breakdown Voltage	$BV_{DSS}$	$I_D = -250\mu A, V_{GS} = 0V$	-20	-	-	V
Zero Gate Voltage Drain Current	$I_{DSS}$	$V_{DS} = -20V, V_{GS} = 0V$	-	-	-1.0	$\mu A$
Gate-to-Source Forward Leakage	$I_{GSS}$	$V_{GS} = \pm 10V, V_{DS} = 0V$	-	-	$\pm 10$	$\mu A$
Gate Threshold Voltage	$V_{GS(th)}$	$V_{DS} = V_{GS}, I_D = -250\mu A$	-0.4	-0.65	-1.0	V
Static Drain-Source On-Resistance	$R_{DS(on)}$	$V_{GS} = -4.5V, I_D = -4A$	-	0.037	0.047	$\Omega$
		$V_{GS} = -2.5V, I_D = -4A$	-	0.049	0.060	$\Omega$
Forward Trans conductance	$g_{FS}$	$V_{DS} = -5V, I_D = -4A$	8	-	-	S
Total Gate Charge	Qg	$I_D = -4A, V_{DS} = -10V, V_{GS} = -4.5V$	-	17	-	nC
Gate-to-Source Charge	Qgs		-	1.2	-	
Gate-to-Drain(Miller) Charge	Qgd		-	4.3	-	
Input Capacitance	$C_{ISS}$	$V_{GS} = 0V, V_{DS} = -10V, f = 1MHz$	-	1250	-	pF
Output Capacitance	$C_{DSS}$		-	200	-	pF
Reverse Transfer Capacitance	$C_{RSS}$		-	155	-	pF
Turn-On Delay Time	$t_{d(on)}$	$V_{DD} = -10V, V_{GS} = -4.5V, R_L = 2.5\Omega, R_{GEN} = 3\Omega$	-	9.3	-	ns
Rise Time	$t_r$		-	15	-	
Turn-Off Delay Time	$t_{d(off)}$		-	80	-	
Fall Time	$t_f$		-	25	-	
Diode Forward Voltage (Note 3)	$V_{SD}$	$V_{GS} = 0V, I_S = 1V$	-	-	-1.2	V
Diode Forward Current (Note 2)	$I_S$		-	-	-2.2	A

**Note1:** Repetitive Rating: Pulse width limited by maximum junction temperature.

**Note2:** Surface Mounted on FR4 Board,  $t \leq 10sec$ .

**Note3:** Pulse Test Pulse Width  $\leq 300\mu s$ , Duty Cycle  $\leq 2\%$ .

Typical Characteristics

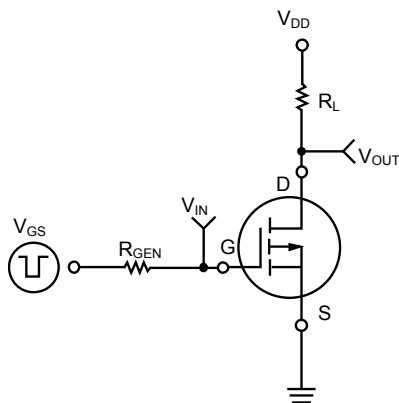

Figure 1. Switching Test Circuit

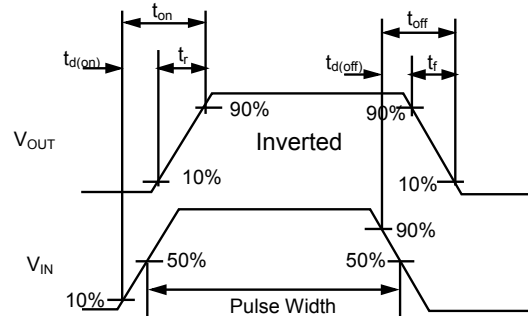

Figure 2. Switching Waveforms

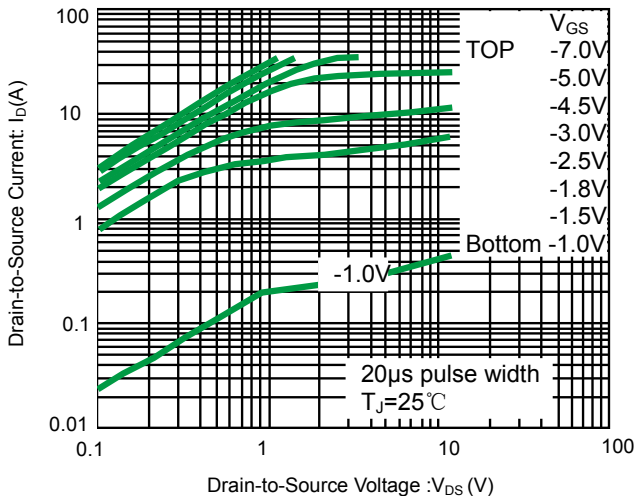

Fig 3. Typical output characteristics

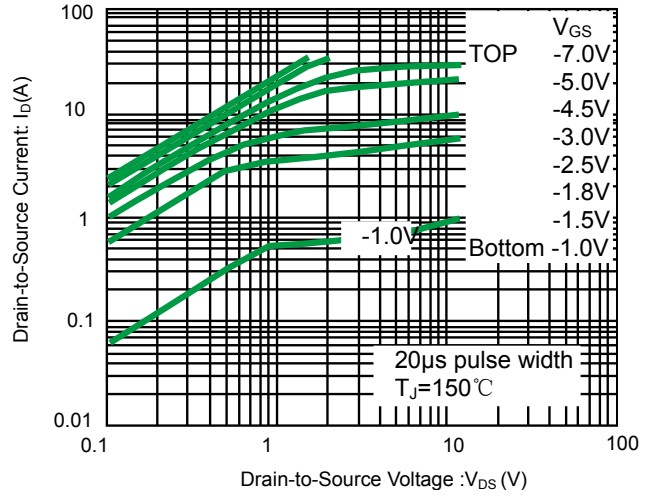

Fig 4. Typical output characteristics

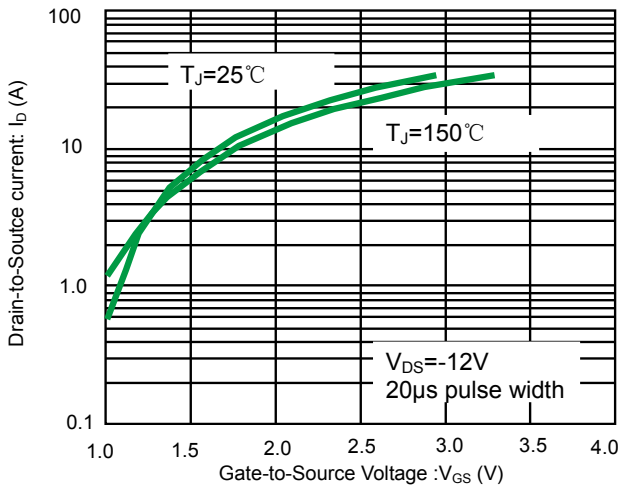

Fig 5. Typical transfer characteristics

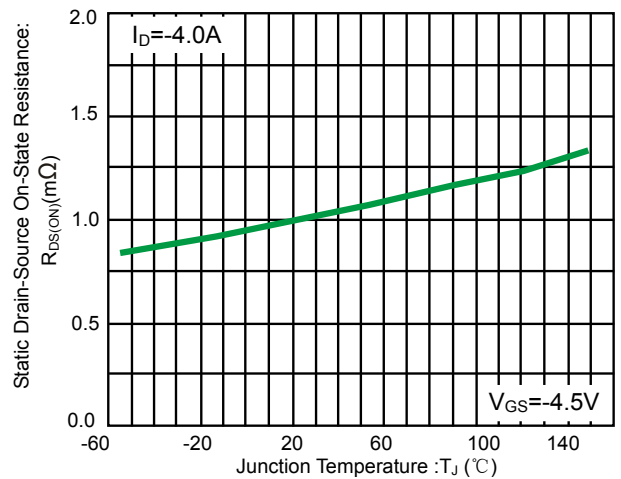

Fig 6. Normalized On-Resistance vs, Temperature

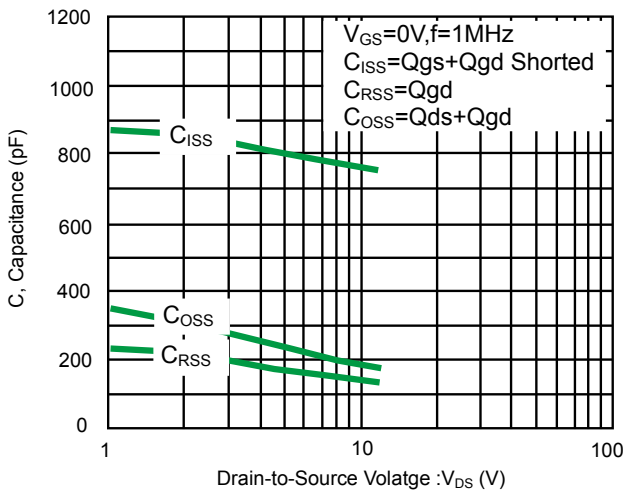

Fig 7. Typical Capacitance vs. Drain-to-Source voltage

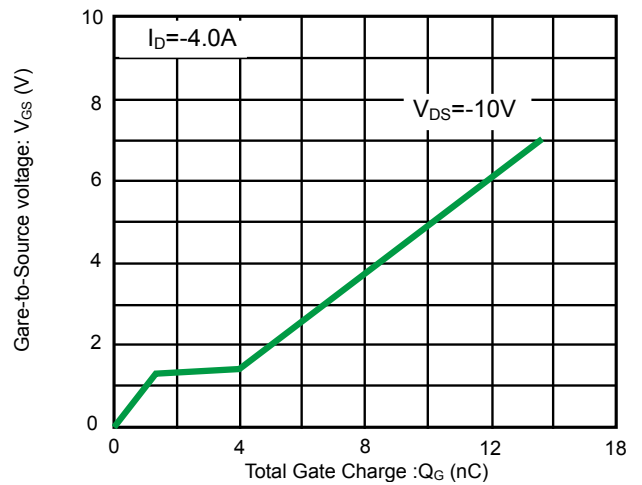

Fig 8. Typical Gate Charge vs. Gate-to-Source voltage

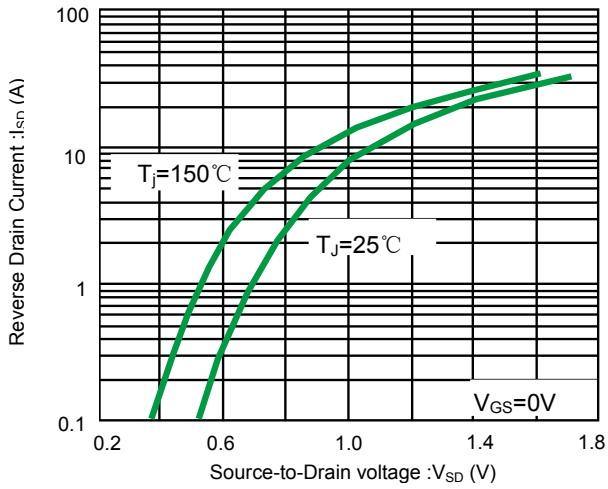

Fig 9. Typical Source-Drain Diode Forward Voltage

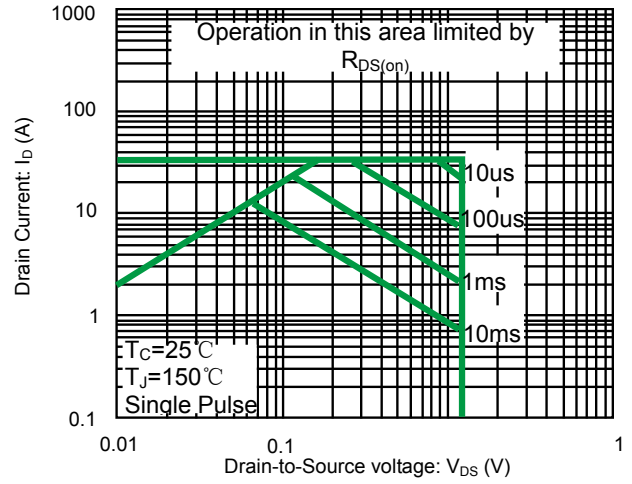

Fig 10. Maximum Safe Operating Area

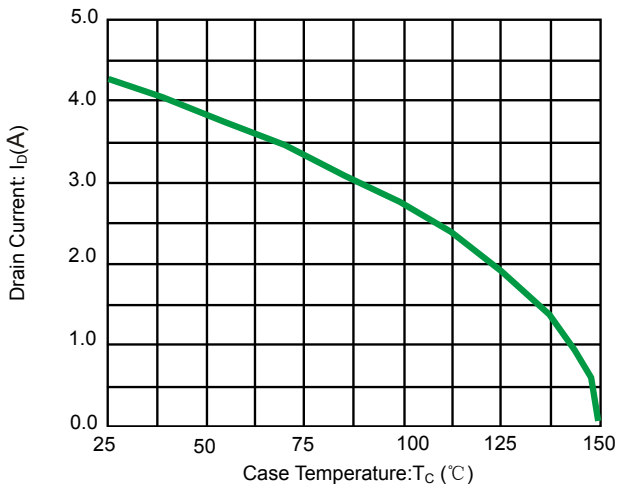

Fig 11. Maximum Drain Current vs. Case Temperature

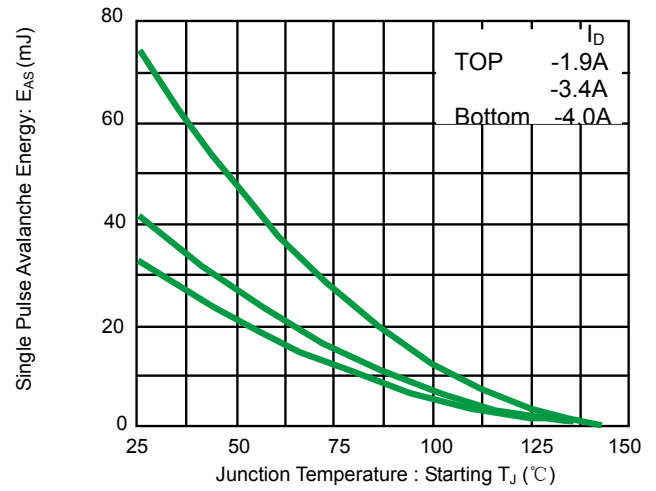

Fig 12. Maximum Avalanche Energy vs. Drain Current

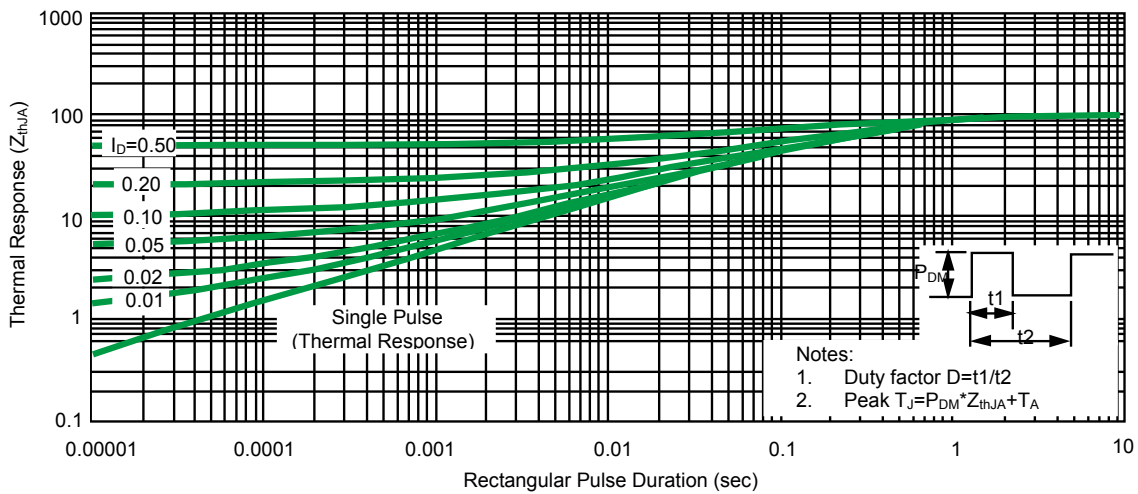

Fig 13. Maximum Effective Transient Thermal Impedance, Junction-to-Ambient

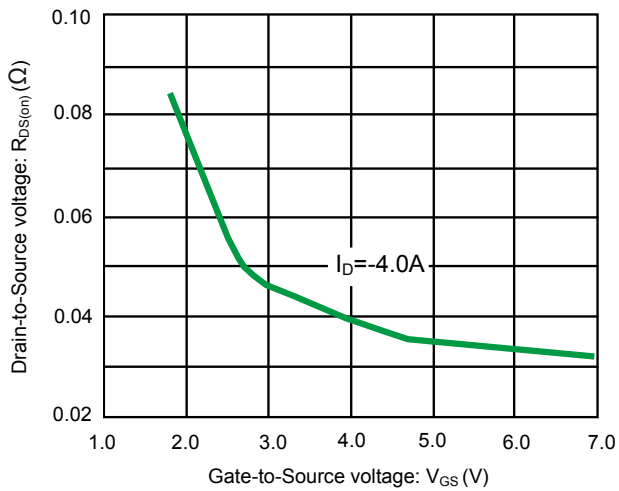

Fig 14. Typical On-Resistance vs. Gate Voltage

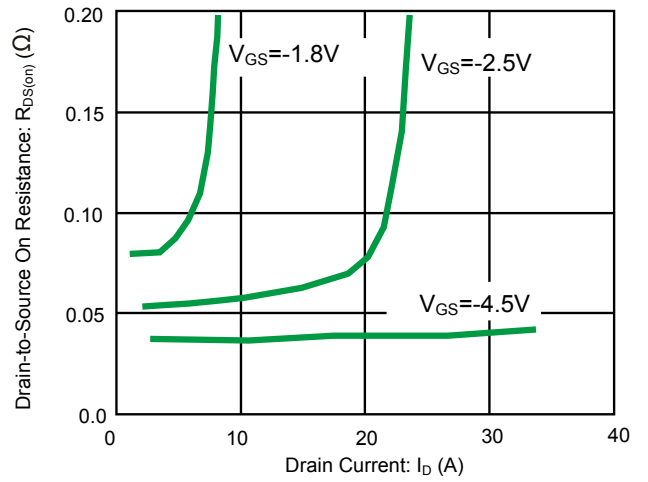

Fig 15. Typical On-Resistance vs. Drain Current

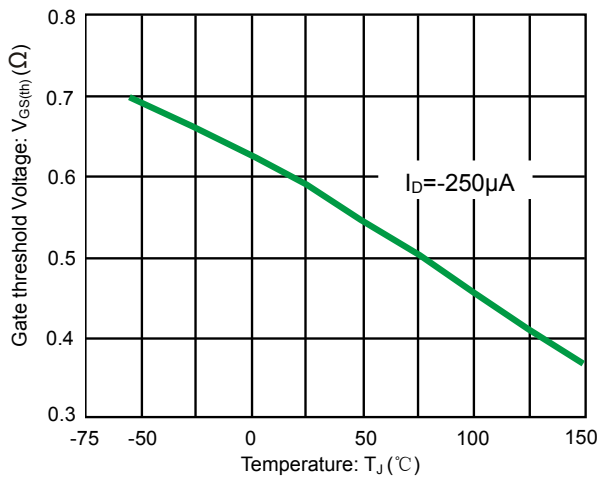
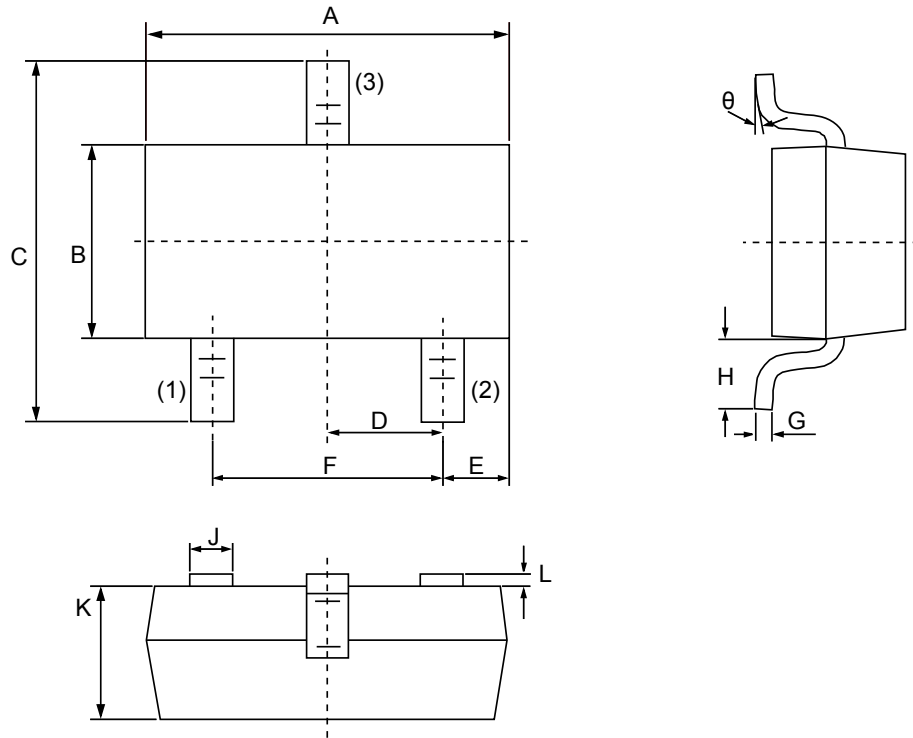



Fig16. Typical Threshold Voltage vs. Junction Temperature

Product dimension(SOT-23)



Dim	Millimeters		Inches	
	MIN	MAX	MIN	MAX
A	2.80	3.00	0.1102	0.1197
B	1.20	1.40	0.0472	0.0551
C	2.10	2.50	0.0830	0.0984
D	0.89	1.02	0.0350	0.0401
E	0.45	0.60	0.0177	0.0236
F	1.78	2.04	0.0701	0.0807
G	0.085	0.177	0.0034	0.0070
H	0.45	0.60	0.0180	0.0236
J	0.37	0.50	0.0150	0.0200
K	0.89	1.11	0.0350	0.0440
L	0.013	0.100	0.0005	0.0040
θ	0°	10°	0°	10°

**IMPORTANT NOTICE**

 and **Prisemi**<sup>®</sup> are registered trademarks of **Prisemi Electronics Co., Ltd (Prisemi)** ,Prisemi reserves the right to make changes without further notice to any products herein. Prisemi makes no warranty, representation or guarantee regarding the suitability of its products for any particular purpose, nor does Prisemi assume any liability arising out of the application or use of any product or circuit, and specifically disclaims any and all liability, including without limitation special, consequential or incidental damages. “Typical” parameters which may be provided in Prisemi data sheets and/or specifications can and do vary in different applications and actual performance may vary over time. All operating parameters, including “Typicals” must be validated for each customer application by customer’s technical experts. Prisemi does not convey any license under its patent rights nor the rights of others. The products listed in this document are designed to be used with ordinary electronic equipment or devices, Should you intend to use these products with equipment or devices which require an extremely high level of reliability and the malfunction of with would directly endanger human life (such as medical instruments, aerospace machinery, nuclear-reactor controllers, fuel controllers and other safety devices), please be sure to consult with our sales representative in advance.

Website: <http://www.prisemi.com>

For additional information, please contact your local Sales Representative.

©Copyright 2009, Prisemi Electronics

 **Prisemi**<sup>®</sup> is a registered trademark of Prisemi Electronics.

All rights are reserved.