

## Fast Switching EmCon Diode

### Feature

- 600 V EmCon technology
- Fast recovery
- Soft switching
- Low reverse recovery charge
- Low forward voltage
- 175°C operating temperature
- Easy paralleling
- Qualified according to JEDEC<sup>0)</sup> for target applications

### Product Summary

$V_{RRM}$	600	V
$I_F$	30	A
$V_F$	1.5	V
$T_{jmax}$	175	°C

PG-TO263-3-2

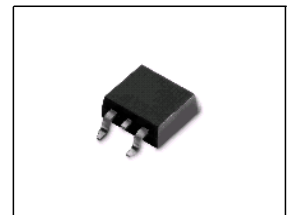

Type	Package	Ordering Code	Marking	Pin 1	PIN 2	PIN 3
IDB30E60	PG-TO263-3-2	-	D30E60	NC	C	A

### Maximum Ratings, at $T_j = 25\text{ °C}$ , unless otherwise specified

Parameter	Symbol	Value	Unit
Repetitive peak reverse voltage	$V_{RRM}$	600	V
Continuous forward current	$I_F$		A
$T_C=25\text{ °C}$		52.3	
$T_C=90\text{ °C}$		34.9	
Surge non repetitive forward current	$I_{FSM}$	117	
$T_C=25\text{ °C}$ , $t_p=10\text{ ms}$ , sine halfwave			
Maximum repetitive forward current	$I_{FRM}$	81	
$T_C=25\text{ °C}$ , $t_p$ limited by $T_{jmax}$ , $D=0.5$			
Power dissipation	$P_{tot}$		W
$T_C=25\text{ °C}$		142.9	
$T_C=90\text{ °C}$		80.9	
Operating and storage temperature	$T_j, T_{stg}$	-55...+175	°C
Soldering temperature	$T_S$	245	°C
reflow soldering, MSL1			

**Thermal Characteristics**

Parameter	Symbol	Values			Unit
		min.	typ.	max.	
<b>Characteristics</b>					
Thermal resistance, junction - case	$R_{thJC}$	-	-	1.05	K/W
Thermal resistance, junction - ambient, leaded	$R_{thJA}$	-	-	62	
SMD version, device on PCB: @ min. footprint @ 6 cm <sup>2</sup> cooling area <sup>1)</sup>	$R_{thJA}$	-	-	62	
		-	35	-	

**Electrical Characteristics, at  $T_j = 25\text{ °C}$ , unless otherwise specified**

Parameter	Symbol	Values			Unit
		min.	typ.	max.	
<b>Static Characteristics</b>					
Reverse leakage current $V_R=600\text{V}$ , $T_j=25\text{°C}$ $V_R=600\text{V}$ , $T_j=150\text{°C}$	$I_R$	-	-	50 2500	$\mu\text{A}$
Forward voltage drop $I_F=30\text{A}$ , $T_j=25\text{°C}$ $I_F=30\text{A}$ , $T_j=150\text{°C}$	$V_F$	-	1.5 1.5	2 -	V

<sup>0</sup>J-STD20 and JESD22

<sup>1</sup>Device on 40mm\*40mm\*1.5mm epoxy PCB FR4 with 6cm<sup>2</sup> (one layer, 70  $\mu\text{m}$  thick) copper area for drain connection. PCB is vertical without blown air.

**Electrical Characteristics, at  $T_j = 25\text{ °C}$ , unless otherwise specified**

Parameter	Symbol	Values			Unit
		min.	typ.	max.	
<b>Dynamic Characteristics</b>					
Reverse recovery time $V_R=400\text{V}$ , $I_F=30\text{A}$ , $di_F/dt=1000\text{A}/\mu\text{s}$ , $T_j=25\text{°C}$ $V_R=400\text{V}$ , $I_F=30\text{A}$ , $di_F/dt=1000\text{A}/\mu\text{s}$ , $T_j=125\text{°C}$ $V_R=400\text{V}$ , $I_F=30\text{A}$ , $di_F/dt=1000\text{A}/\mu\text{s}$ , $T_j=150\text{°C}$	$t_{rr}$	-	126 171 178	-	ns
Peak reverse current $V_R=400\text{V}$ , $I_F = 30\text{A}$ , $di_F/dt=1000\text{A}/\mu\text{s}$ , $T_j=25\text{°C}$ $V_R=400\text{V}$ , $I_F = 30\text{A}$ , $di_F/dt=1000\text{A}/\mu\text{s}$ , $T_j=125\text{°C}$ $V_R=400\text{V}$ , $I_F = 30\text{A}$ , $di_F/dt=1000\text{A}/\mu\text{s}$ , $T_j=150\text{°C}$	$I_{rrm}$	-	19 22 24	-	A
Reverse recovery charge $V_R=400\text{V}$ , $I_F=30\text{A}$ , $di_F/dt=1000\text{A}/\mu\text{s}$ , $T_j=25\text{°C}$ $V_R=400\text{V}$ , $I_F = 30\text{A}$ , $di_F/dt=1000\text{A}/\mu\text{s}$ , $T_j=125\text{°C}$ $V_R=400\text{V}$ , $I_F = 30\text{A}$ , $di_F/dt=1000\text{A}/\mu\text{s}$ , $T_j=150\text{°C}$	$Q_{rr}$	-	1100 1950 2150	-	nC
Reverse recovery softness factor $V_R=400\text{V}$ , $I_F=30\text{A}$ , $di_F/dt=1000\text{A}/\mu\text{s}$ , $T_j=25\text{°C}$ $V_R=400\text{V}$ , $I_F=30\text{A}$ , $di_F/dt=1000\text{A}/\mu\text{s}$ , $T_j=125\text{°C}$ $V_R=400\text{V}$ , $I_F=30\text{A}$ , $di_F/dt=1000\text{A}/\mu\text{s}$ , $T_j=150\text{°C}$	S	-	4 4.6 4.8	-	

**1 Power dissipation**

$P_{tot} = f(T_C)$

parameter:  $T_j \leq 175\text{ °C}$

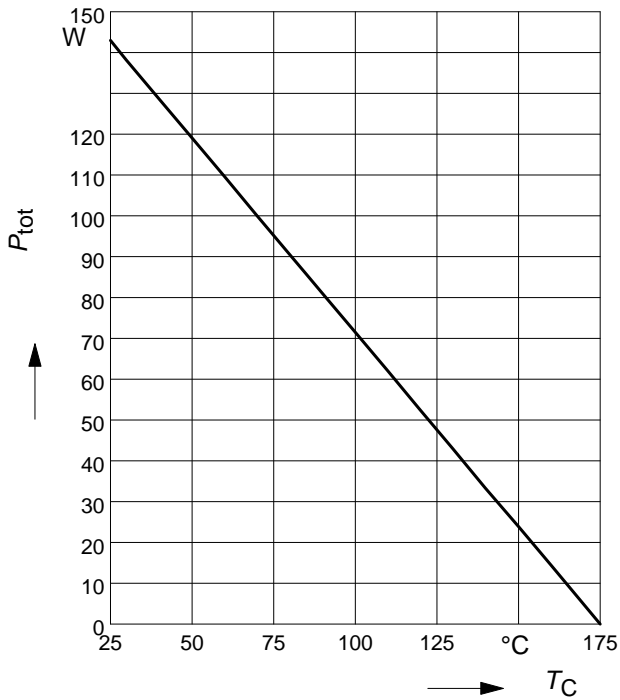

**2 Diode forward current**

$I_F = f(T_C)$

parameter:  $T_j \leq 175\text{ °C}$

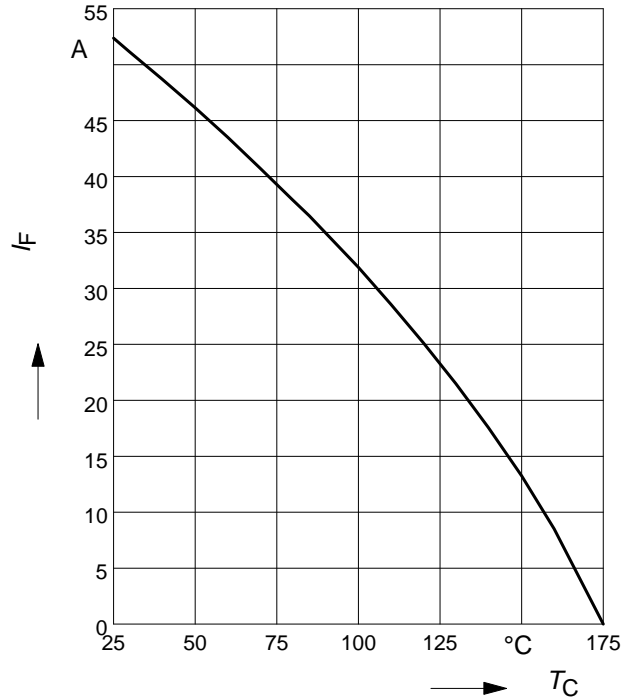

**3 Typ. diode forward current**

$I_F = f(V_F)$

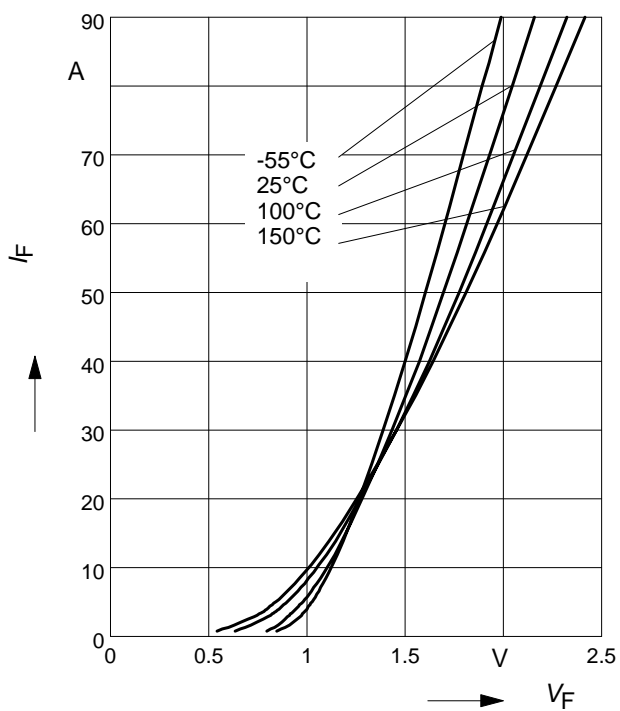

**4 Typ. diode forward voltage**

$V_F = f(T_j)$

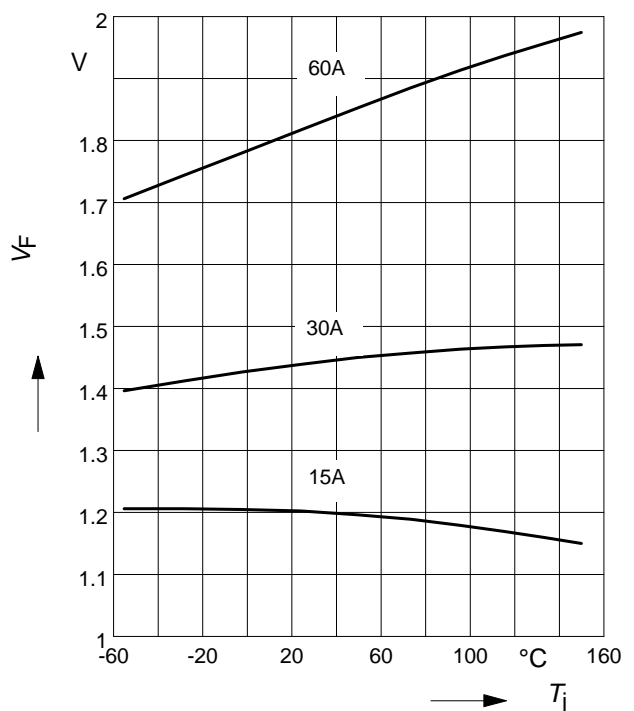

**5 Typ. reverse recovery time**

$$t_{rr} = f(dI_F/dt)$$

parameter:  $V_R = 400V, T_j = 125^\circ C$

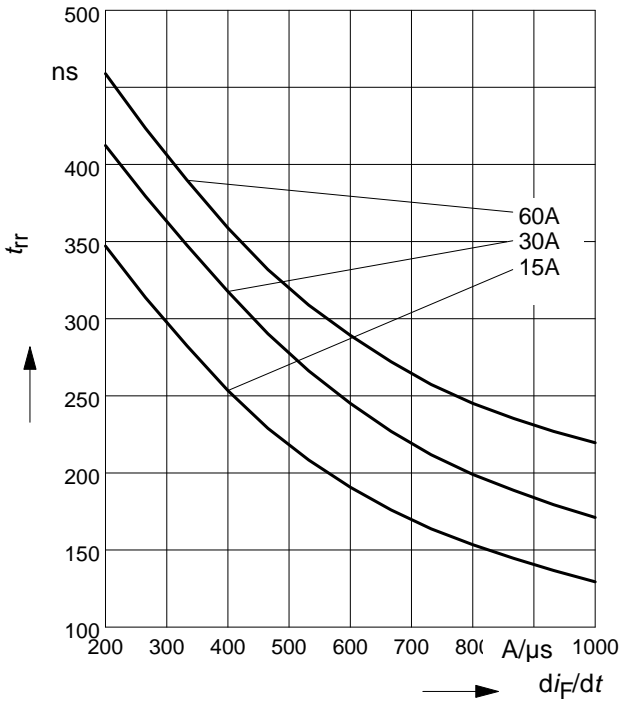

**6 Typ. reverse recovery charge**

$$Q_{rr} = f(dI_F/dt)$$

parameter:  $V_R = 400V, T_j = 125^\circ C$

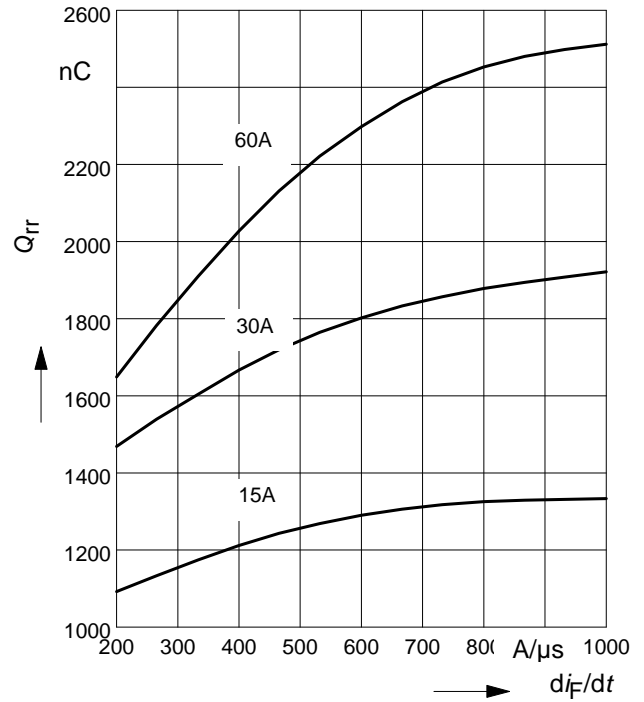

**7 Typ. reverse recovery current**

$$I_{rr} = f(dI_F/dt)$$

parameter:  $V_R = 400V, T_j = 125^\circ C$

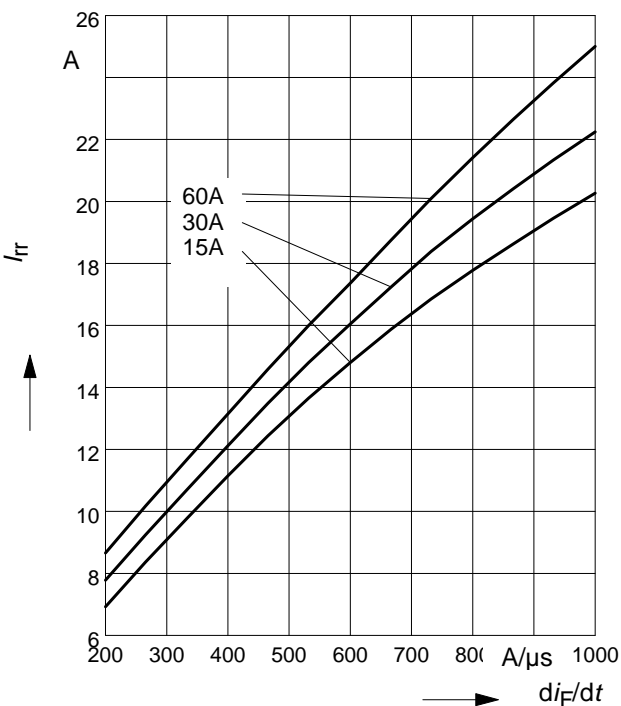

**8 Typ. reverse recovery softness factor**

$$S = f(dI_F/dt)$$

parameter:  $V_R = 400V, T_j = 125^\circ C$

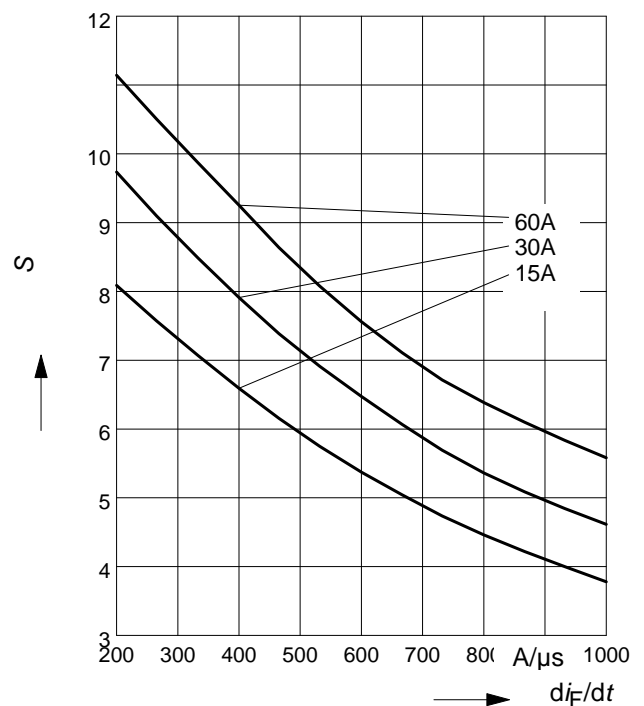

**9 Max. transient thermal impedance**

$$Z_{thJC} = f(t_p)$$

parameter :  $D = t_p/T$

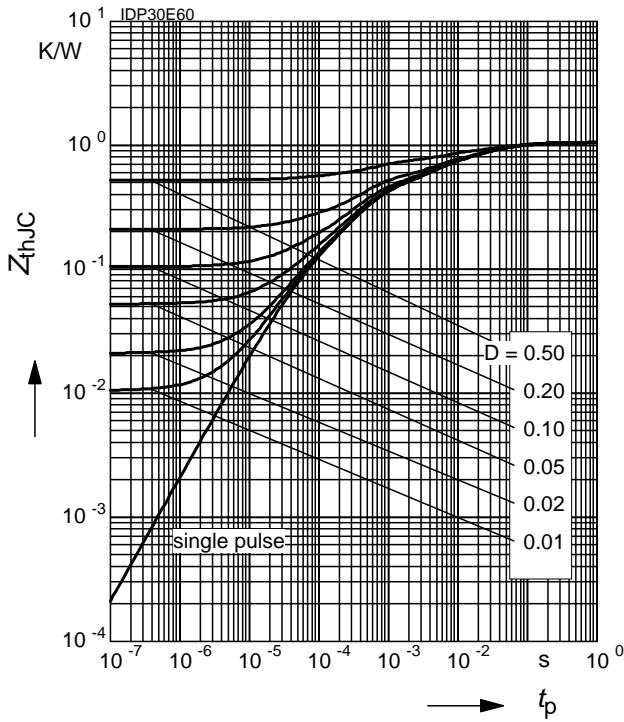

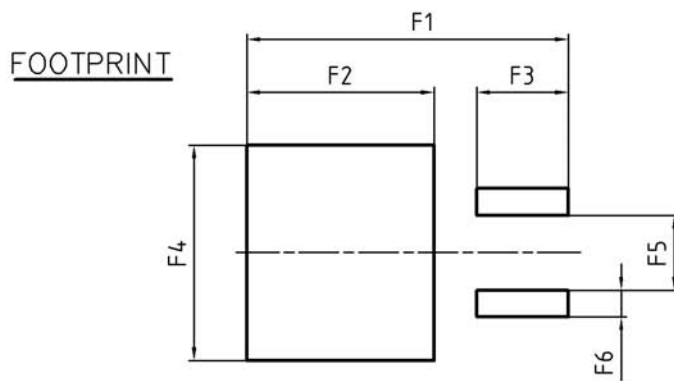
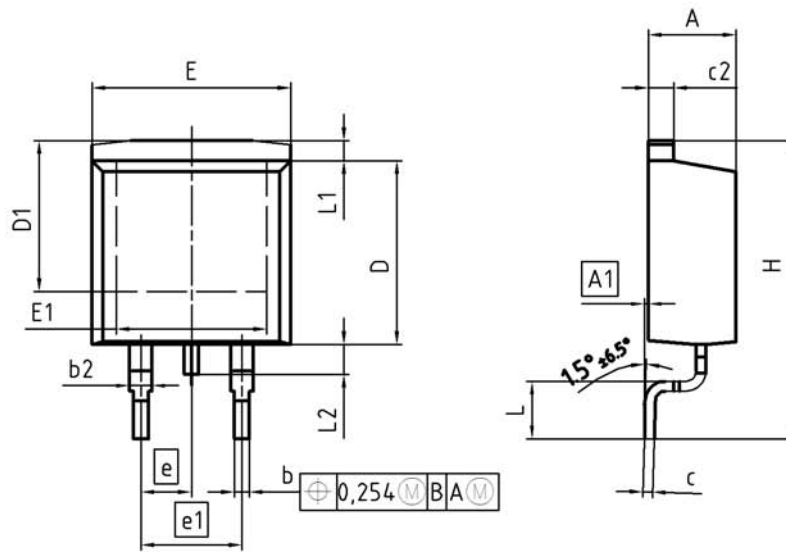

DIM	MILLIMETERS		INCHES	
	MIN	MAX	MIN	MAX
A	4.30	4.57	0.169	0.180
A1	0.00	0.25	0.000	0.010
b	0.65	0.85	0.026	0.033
b2	0.95	1.15	0.037	0.045
c	0.33	0.65	0.013	0.026
c2	1.17	1.40	0.046	0.055
D	8.51	9.45	0.335	0.372
D1	7.10	7.90	0.280	0.311
E	9.80	10.31	0.386	0.406
E1	6.50	8.60	0.256	0.339
e	2.54		0.100	
e1	5.08		0.200	
N	2		2	
H	14.61	15.88	0.575	0.625
L	2.29	3.00	0.090	0.118
L1	0.70	1.60	0.028	0.063
L2	1.00	1.78	0.039	0.070
F1	16.05	16.25	0.632	0.640
F2	9.30	9.50	0.366	0.374
F3	4.50	4.70	0.177	0.185
F4	10.70	10.90	0.421	0.429
F5	3.65	3.85	0.144	0.152
F6	1.25	1.45	0.049	0.057

DOCUMENT NO.  
Z8B00003324

SCALE

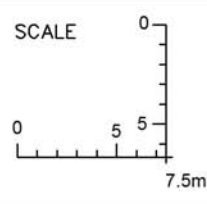

EUROPEAN PROJECTION

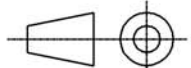

ISSUE DATE  
30-08-2007

REVISION  
01

**Published by**  
**Infineon Technologies AG,**  
**Bereichs Kommunikation**  
**St.-Martin-Strasse 53,**  
**D-81541 München**  
**© Infineon Technologies AG 1999**  
**All Rights Reserved.**

**Attention please!**

The information herein is given to describe certain components and shall not be considered as warranted characteristics.

Terms of delivery and rights to technical change reserved.

We hereby disclaim any and all warranties, including but not limited to warranties of non-infringement, regarding circuits, descriptions and charts stated herein.

Infineon Technologies is an approved CECC manufacturer.

**Information**

For further information on technology, delivery terms and conditions and prices please contact your nearest Infineon Technologies Office in Germany or our Infineon Technologies Representatives worldwide (see address list).

**Warnings**

Due to technical requirements components may contain dangerous substances.

For information on the types in question please contact your nearest Infineon Technologies Office.

Infineon Technologies Components may only be used in life-support devices or systems with the express written approval of Infineon Technologies, if a failure of such components can reasonably be expected to cause the failure of that life-support device or system, or to affect the safety or effectiveness of that device or system. Life support devices or systems are intended to be implanted in the human body, or to support and/or maintain and sustain and/or protect human life. If they fail, it is reasonable to assume that the health of the user or other persons may be endangered.



**This datasheet has been downloaded from:**

**[www.EEworld.com.cn](http://www.EEworld.com.cn)**

**Free Download**

**Daily Updated Database**

**100% Free Datasheet Search Site**

**100% Free IC Replacement Search Site**

**Convenient Electronic Dictionary**

**Fast Search System**

**[www.EEworld.com.cn](http://www.EEworld.com.cn)**

**This datasheet has been downloaded from:**

**[www.EEworld.com.cn](http://www.EEworld.com.cn)**

**Free Download**

**Daily Updated Database**

**100% Free Datasheet Search Site**

**100% Free IC Replacement Search Site**

**Convenient Electronic Dictionary**

**Fast Search System**

**[www.EEworld.com.cn](http://www.EEworld.com.cn)**