

4855452 INTERNATIONAL RECTIFIER

55C 05091 D
Data Sheet No. PD-2.039B

T-03-19

INTERNATIONAL RECTIFIER 

30FQ & 30FQ-A SERIES

30 Amp Schottky Power Rectifiers

Major Ratings and Characteristics

Characteristic	30FQ	30FQ-A	Units
$I_F(AV)$ @ 180° Rectangular	30		A
I_{FSM} @ 50 Hz	575		A
I^2t @ 50 Hz	1650		A ² s
$I^2\sqrt{t}$	23,000	25,000	A ² \sqrt{s}
V_{RWM}	30 to 45		V
$C_t @ -5V$	2000		pF
T_J	-65 to 175		°C

Description/Features

The 30FQ and 30FQ-A Series Schottky rectifiers are designed to be operated at 175°C T_J. They employ the "830" process which results in a very low ratio of reverse leakage current to junction temperature. In addition to improvements in reliability and performance, they are rugged devices with a guaranteed repetitive peak reverse voltage capability and excellent ability to withstand reverse energy transients. They can be used for both existing and new designs.

- 175°C T_J operation
- High current at high temperature
- Extremely low reverse leakage: 25 mA at 125°C
- No voltage derating up to 175°C
- Provides extremely high power supply reliability
- No thermal runaway within operating and temperature parameters.
- A guaranteed repetitive peak reverse voltage capability for short pulses which is 20% above V_{RWM}
- Ability to withstand reverse energy transients
- Can be supplied to meet stringent military, aerospace and other high-reliability requirements.



CASE STYLE AND DIMENSIONS

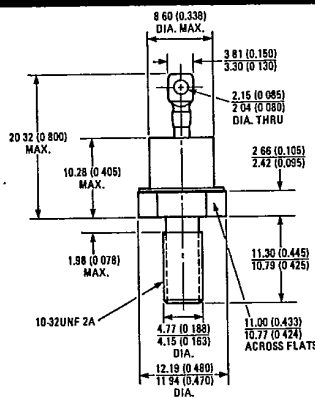
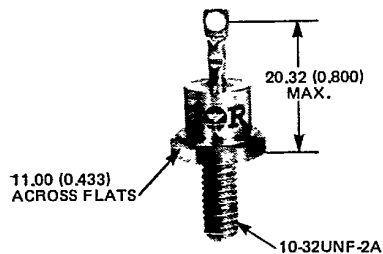

Case Style DO-203AA (DO-4)
All Dimensions in Millimeters and (Inches)

4855452 INTERNATIONAL RECTIFIER
30FQ & 30FQ-A Series

55C 05092 D
INTERNATIONAL RECTIFIER 

T-03-19

VOLTAGE RATINGS

Part Numbers		V _{RWM} - Max. Working Peak Reverse Voltage (V) ①	V _{RRM} - Max. Repetitive Peak Reverse Voltage (V) ② (200 ns Max. Pulse Width)	V _R - Max. Direct Reverse Voltage (V) ③
30FQ030	30FQ030A	30	36	30
30FQ035	30FQ035A	35	42	35
30FQ040	30FQ040A	40	48	40
30FQ045	30FQ045A	45	54	45

ELECTRICAL SPECIFICATIONS

	30FQ	30FQ-A	Units	Conditions
I _{F(AV)} Max. average forward current	30		A	180° conduction, rectangular waveform @ T _C = -65 to 119°C for 30FQ, and @ T _C = -65 to 123°C for 30FQ-A.
	27			180° conduction, sinusoidal waveform
I _{FSM} Max. peak one cycle, non-repetitive surge current	575	590	A	60 Hz Half cycle, sine wave or 6 ms rectangular pulse, following any rated load condition, and with rated V _{RWM} applied following surge.
	600	620		60 Hz Half cycle, sine wave or 5 ms rectangular pulse, following any rated load condition, and with rated V _{RWM} applied following surge.
	680	705		50 Hz With V _{RWM} = 0 following surge, initial T _J = 175°C
	715	735		60 Hz
i ² t Max. i ² t for fusing	1,650	1,750	A ² s	10 ms With rated V _{RWM} applied following surge, initial T _J = 175°C.
	1,600	1,600		8.3 ms
i ² t Max. i ² t for individual device fusing	2,300	2,500	A ² s	10 ms With V _{RWM} applied following surge = 0, initial T _J = 175°C.
	2,100	2,250		8.3 ms
i ² √t Max. i ² √t for individual device fusing ④	23,000	25,000	A ² √s	t = 0.1 to 10 ms, V _{RWM} following surge = 0, initial T _J = 175°C
V _{FM} Max. peak forward voltage	0.83	0.75	V	T _J = 25°C Rated I _{F(AV)} (60A peak) 180° conduction, T _J = 175°C rectangular waveform
	0.73	0.67		T _J = 25°C @ I _{FM} = 30A
	0.67	0.60		T _J = 25°C @ I _{FM} = 20A
	0.60	0.54		
I _{RM} Max. peak reverse current	15		mA	T _J = 25°C
	30			At max. rated V _{RWM} T _J = 125°C
I _{RRM} Max. repetitive peak reverse current	2.0		A	T _C = 25°C, f = 1 kHz, see fig. 1.6 for test circuit
C _t Max. capacitance	2000		pF	T _C = 25°C, V _R = 5 Vdc (Test signal in the range of 100 kHz to 1 MHz.)
dv/dt Max. rate of reverse voltage application	1000		V/μs	T _C = 25°C, V _{RM} = rated V _{RWM}

THERMAL-MECHANICAL SPECIFICATIONS

T _J Max. operating junction temperature range	-65 to 175	°C	
T _{stg} Max. storage temperature range	-65 to 175	°C	
R _{thJC} Max. thermal resistance, junction-to-case	2.0	deg C/W	DC operation
R _{thCS} Max. thermal resistance, case-to-sink	0.50	deg C/W	Mounting surface flat, smooth and greased
T Mounting torque	Min. 1.35 (12) Max. 1.70 (15)	Nm (lbf in)	Non-lubricated threads
wt Approximate weight	5.7 (0.20)	g (oz)	
Case style	DO-203AA (DO-4)		JEDEC

① T_C = -65°C to 167°C, 180° conduction.

③ T_C = 0°C to 167°C, 180° conduction.

② T_C = -65°C to 148°C

④ i²t for time t_x = i²√t · √t_x

4855452 INTERNATIONAL RECTIFIER
INTERNATIONAL RECTIFIER **IR**

55C 05093 D
30FQ & 30FQ-A Series

30FQ Series

T-03-19

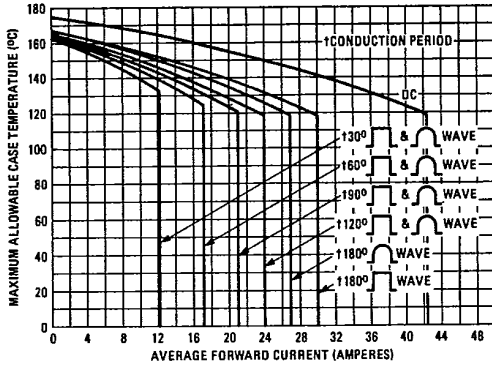

Fig. 1 - Maximum Allowable Case Temperature Vs. Forward Current

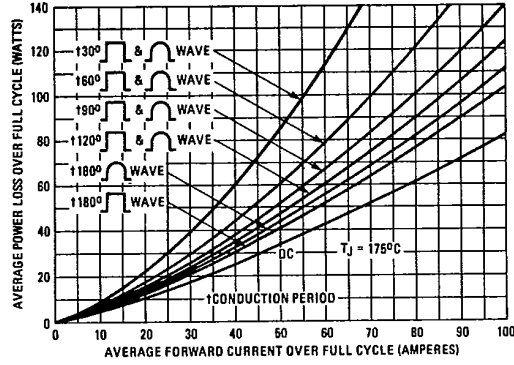

Fig. 2 - Maximum Forward Power Loss Vs. Forward Current

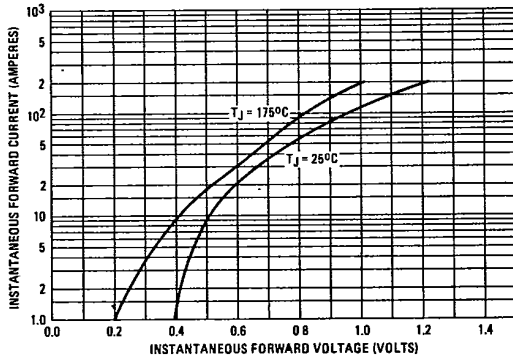

Fig. 3 - Maximum Forward Voltage Vs. Forward Current

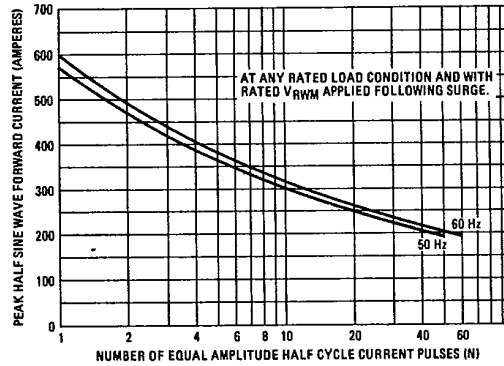

Fig. 4 - Maximum Non-Repetitive Surge Current Vs. Number of Cycles

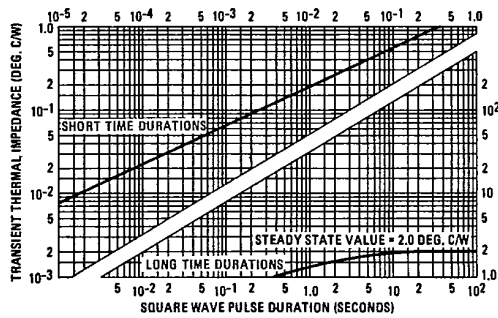

Fig. 5 - Maximum Transient Thermal Impedance, Junction-to-Case Vs. Square Wave Pulse Duration

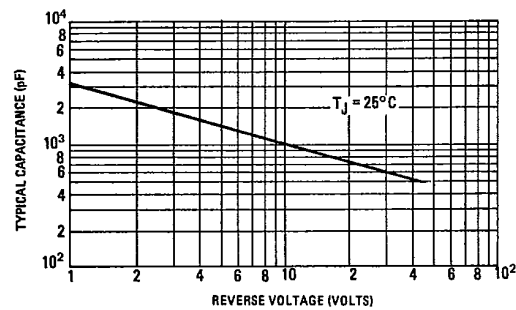

Fig. 6 - Typical Capacitance Vs. Reverse Voltage



4855452 INTERNATIONAL RECTIFIER
30FQ & 30FQ-A Series

55C 05094 D
INTERNATIONAL RECTIFIER 

30FQ Series

T-03-19

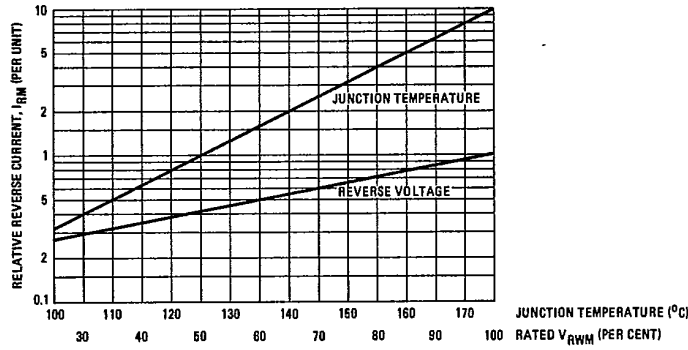

Fig. 7 - Typical Variation of Reverse Current Vs. Junction Temperature and Reverse Voltage

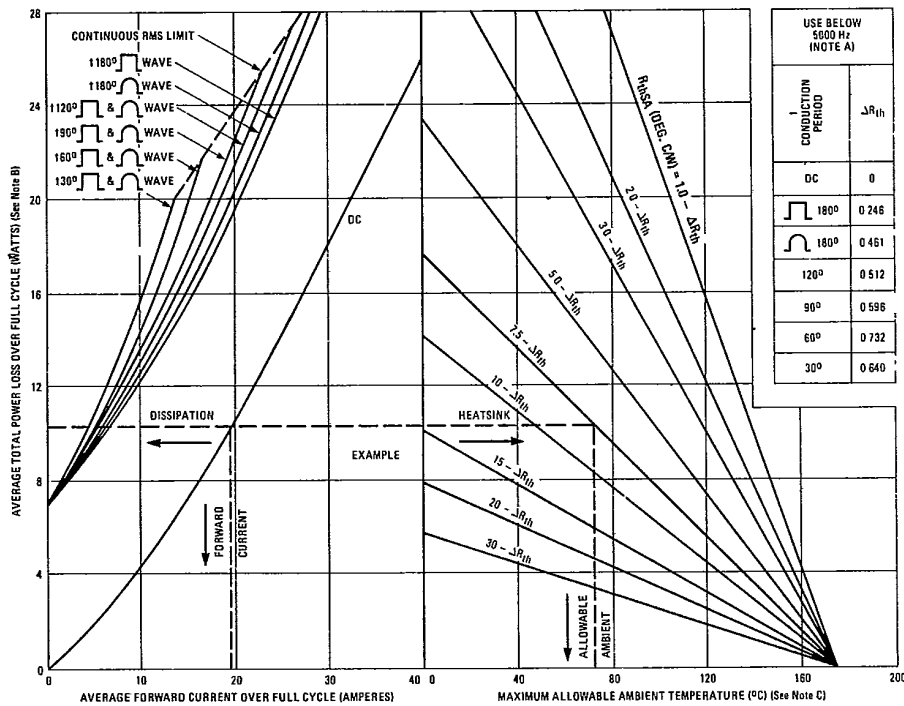

Fig. 8 - Thermal Nomogram

- Notes. A. Maximum allowable heatsink thermal resistance, R_{thSA} , equals the graph value minus the ΔR_{th} factor which allows for instantaneous T_j excursion. At frequencies above 5000 Hz, ΔR_{th} becomes essentially zero and can be ignored.
- B. The total power dissipation curves assume the worst case reverse conditions of half-wave (180°) rectangular reverse voltage, full rated V_R , and $T_j = 175^\circ\text{C}$. Lower reverse power losses allow higher operating ambient, smaller heatsinks or larger operating safety margin.
- C. Caution. Data assumes that the rectifier is mounted with thermally conductive grease to achieve $R_{thCS} = 0.50$ deg. CW.

4855452 INTERNATIONAL RECTIFIER

55C 05095 D
30FQ & 30FQ-A Series



T-03-19

30FQ-A Series

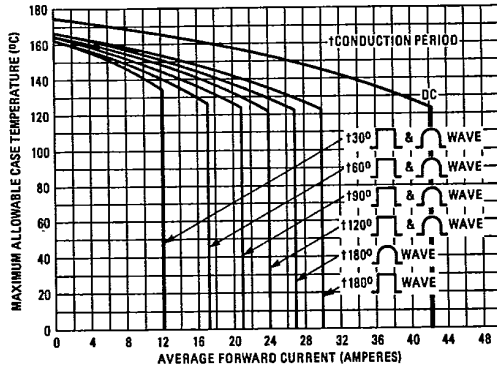

Fig. 9 - Maximum Allowable Case Temperature Vs. Forward Current

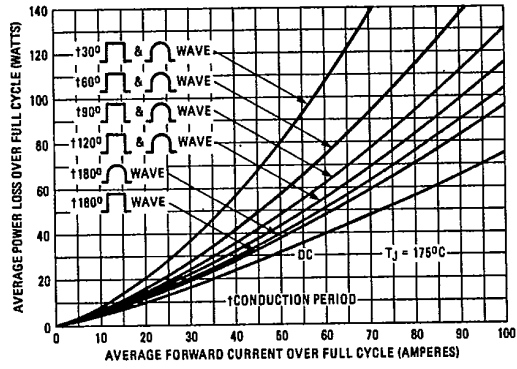

Fig. 10 - Maximum Forward Power Loss Vs. Forward Current

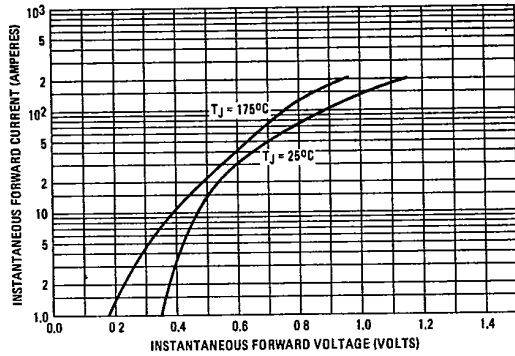

Fig. 11 - Maximum Instantaneous Forward Voltage Vs. Forward Current

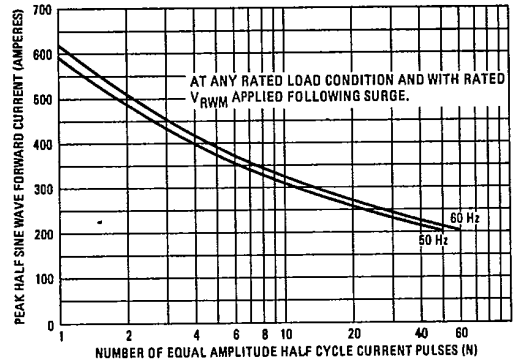

Fig. 12 - Maximum Non-Repetitive Surge Current Vs. Number of Current Pulses

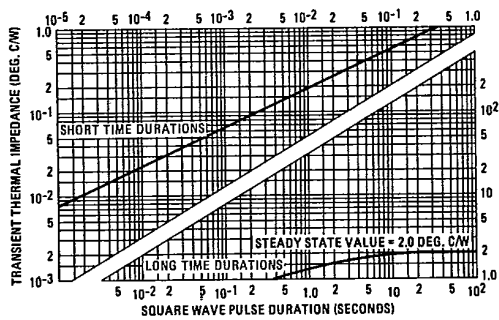

Fig. 13 - Maximum Transient Thermal Impedance, Junction-to-Case Vs. Square Wave Pulse Duration

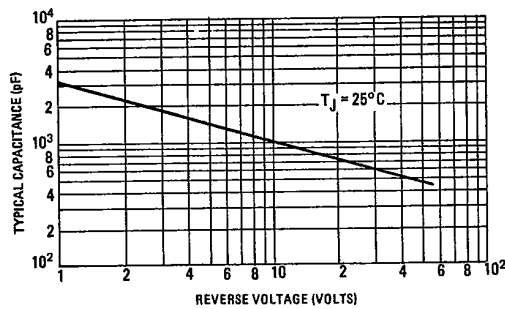

Fig. 14 - Typical Capacitance Vs. Reverse Voltage

C

4855452 INTERNATIONAL RECTIFIER
30FQ & 30FQ-A Series

55C 05096 D
INTERNATIONAL RECTIFIER **IR**

T-03-19

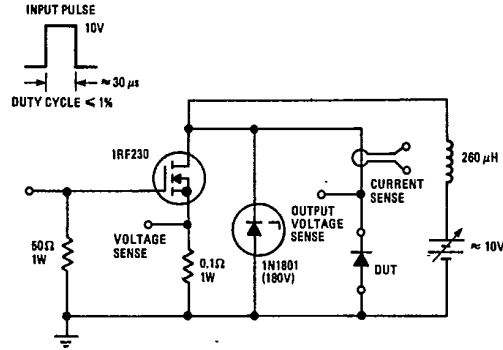
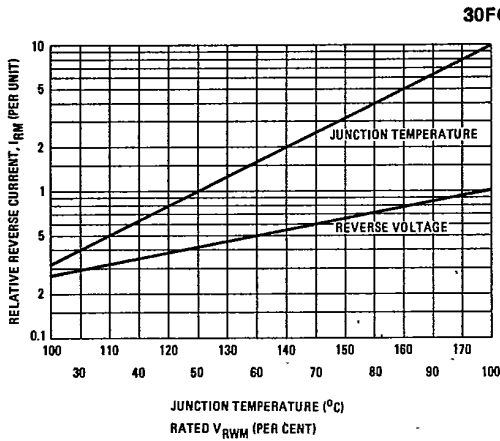

Fig. 16 - I_{RRM} Test Circuit

Fig. 15 - Typical Variation of Reverse Current Vs. Junction Temperature and Reverse Voltage

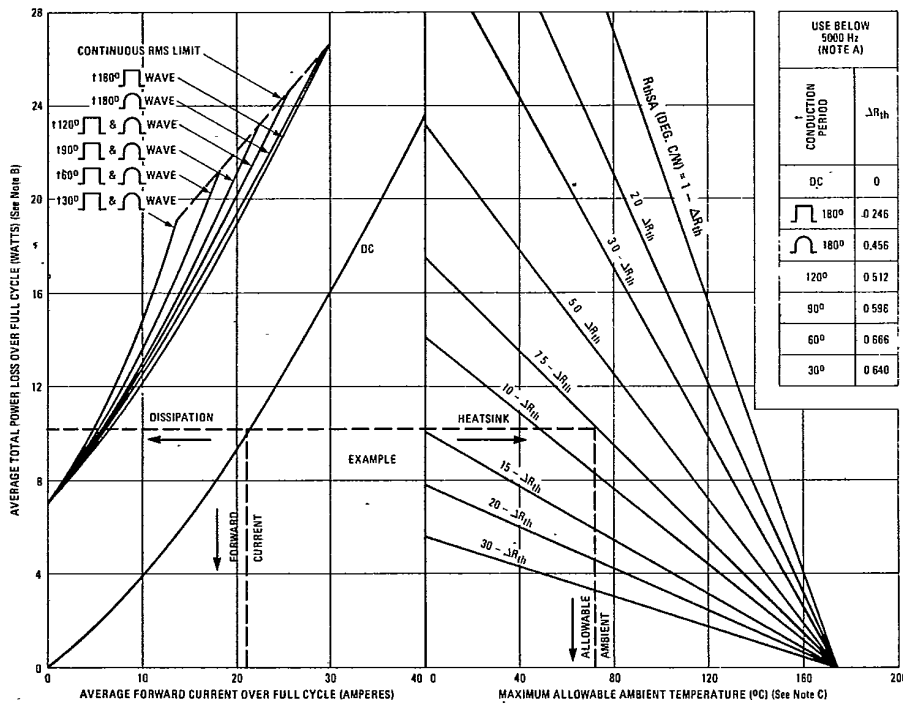

Fig. 17 - Thermal Nomogram

- Notes:
- Maximum allowable heatsink thermal resistance, R_{thSA} , equals the graph value minus the ΔR_{th} factor which allows for instantaneous T_j excursion. At frequencies above 5000 Hz, ΔR_{th} becomes essentially zero and can be ignored.
 - The total power dissipation curves assume the worst case reverse conditions of halfwave (180°) rectangular reverse voltage, full rated V_R , and $T_j = 175^\circ C$. Lower reverse power losses allow higher operating ambient, smaller heatsinks or larger operating safety margin.
 - Caution: Data assumes that the rectifier is mounted with thermally conductive grease to achieve $R_{thCS} = 0.50$ deg. C/W