

## 100 V, 30 A power Schottky rectifier

### Features

- Avalanche rated
- Low  $V_F$
- Good trade off between leakage current and forward voltage drop
- High frequency operation
- Avalanche capability specified

### Description

The STPS30M100S device is a single Schottky rectifier, suited for high frequency switch mode power supply.

Packaged in TO-220AB, TO-220FPAB, and I<sup>2</sup>PAK this device is intended to be used in notebook and game station adaptors, providing in these applications a good efficiency at both low and high load.

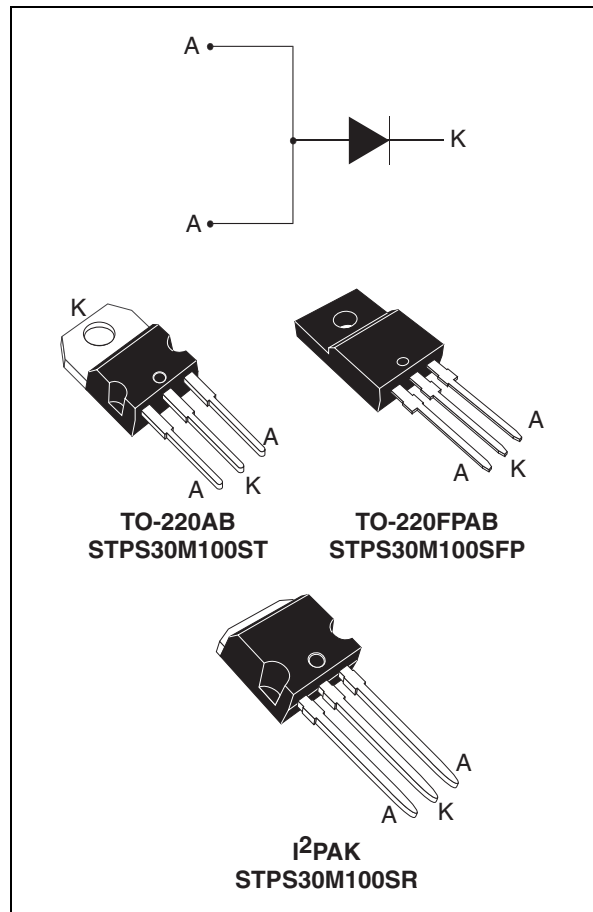

**Figure 1. Electrical characteristics (a)**

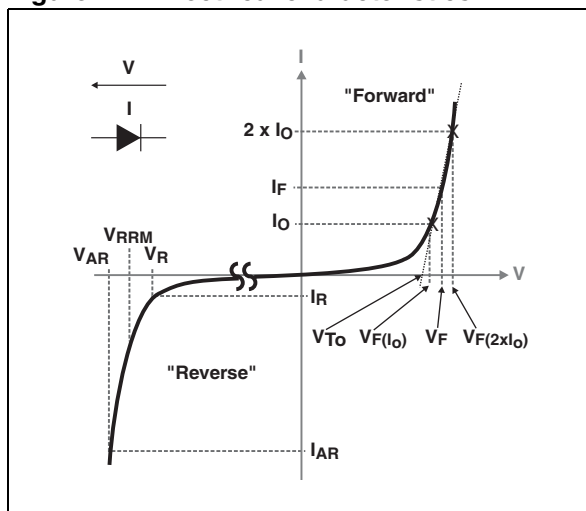

**Table 1. Device summary**

$I_{F(AV)}$	30 A
$V_{RRM}$	100 V
$T_j$ (max)	150 °C
$V_F$ (typ)	0.385 V

- a.  $V_{ARM}$  and  $I_{ARM}$  must respect the reverse safe operating area defined in [Figure 14](#).  $V_{AR}$  and  $I_{AR}$  are pulse measurements ( $t_p < 1 \mu s$ ).  $V_R$ ,  $I_R$ ,  $V_{RRM}$  and  $V_F$  are static characteristics

# 1 Characteristics

**Table 2. Absolute ratings (limiting values)**

Symbol	Parameter	Value	Unit	
V <sub>RRM</sub>	Repetitive peak reverse voltage	100	V	
I <sub>F(RMS)</sub>	Forward rms current	60	A	
I <sub>F(AV)</sub>	Average forward current $\delta = 0.5$	T <sub>c</sub> = 125 °C	30	A
I <sub>FSM</sub>	Surge non repetitive forward current	t <sub>p</sub> = 10 ms sinusoidal	300	A
P <sub>ARM</sub>	Repetitive peak avalanche power	t <sub>p</sub> = 1 $\mu$ s T <sub>j</sub> = 25 °C	26400	W
V <sub>ARM</sub> <sup>(1)</sup>	Maximum repetitive peak avalanche voltage	t <sub>p</sub> < 1 $\mu$ s T <sub>j</sub> < 150 °C I <sub>AR</sub> < 66 A	120	V
V <sub>ASM</sub> <sup>(1)</sup>	Maximum single pulse peak avalanche voltage	t <sub>p</sub> < 1 $\mu$ s T <sub>j</sub> < 150 °C I <sub>AR</sub> < 66 A	120	V
T <sub>stg</sub>	Storage temperature range	-65 to + 175	°C	
T <sub>j</sub>	Maximum operating junction temperature <sup>(2)</sup>	150	°C	

1. Refer to [Figure 14](#).

2.  $\frac{dP_{tot}}{dT_j} < \frac{1}{R_{th(j-a)}}$  condition to avoid thermal runaway for a diode on its own heatsink

**Table 3. Thermal resistance**

Symbol	Parameter	Value	Unit
R <sub>th(j-c)</sub>	Junction to case	TO-220AB, I <sup>2</sup> PAK	1
		TO-220FPAB	4

**Table 4. Static electrical characteristics with all leads connected on board**

Symbol	Parameter	Test conditions	Min.	Typ.	Max.	Unit	
I <sub>R</sub> <sup>(1)</sup>	Reverse leakage current	T <sub>j</sub> = 25 °C	V <sub>R</sub> = V <sub>RRM</sub>	-	-	175	$\mu$ A
		T <sub>j</sub> = 125 °C		-	20	50	mA
		T <sub>j</sub> = 25 °C	V <sub>R</sub> = 70 V	-	-	60	$\mu$ A
		T <sub>j</sub> = 125 °C		-	10	20	mA
V <sub>F</sub> <sup>(2)</sup>	Forward voltage drop	T <sub>j</sub> = 25 °C	I <sub>F</sub> = 5 A	-	0.475	-	V
		T <sub>j</sub> = 125 °C		-	0.385	-	
		T <sub>j</sub> = 25 °C	I <sub>F</sub> = 10 A	-	0.555	-	
		T <sub>j</sub> = 125 °C		-	0.475	--	
		T <sub>j</sub> = 25 °C	I <sub>F</sub> = 15 A	-	0.620	0.660	
		T <sub>j</sub> = 125 °C		-	0.525	0.565	
		T <sub>j</sub> = 25 °C	I <sub>F</sub> = 30 A	-	0.740	0.800	
		T <sub>j</sub> = 125 °C		-	0.605	0.655	

1. Pulse test: t<sub>p</sub> = 5 ms,  $\delta < 2\%$

2. Pulse test: t<sub>p</sub> = 380  $\mu$ s,  $\delta < 2\%$

To evaluate the conduction losses use the following equation:  
 $P = 0.475 \times I_{F(AV)} + 0.006 \times I_F^2(RMS)$

Figure 2. Conduction losses versus average current

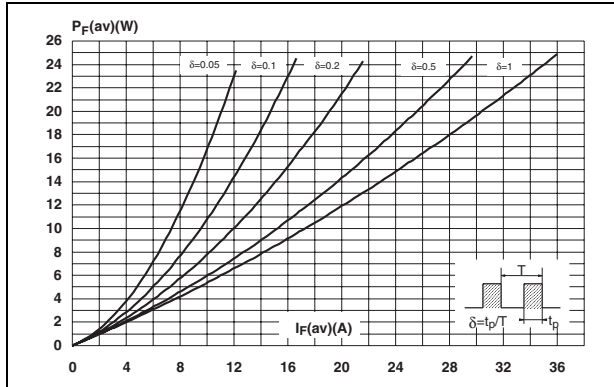

Figure 3. Average forward current versus ambient temperature (delta = 0.5)

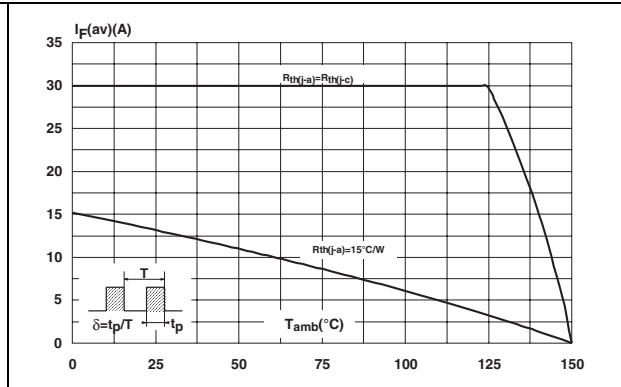

Figure 4. Normalized avalanche power derating versus pulse duration

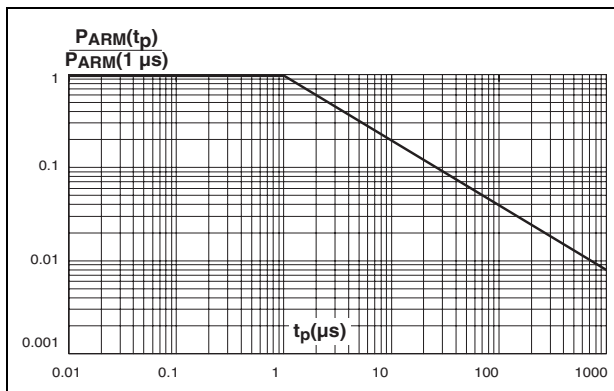

Figure 5. Normalized avalanche power derating versus junction temperature

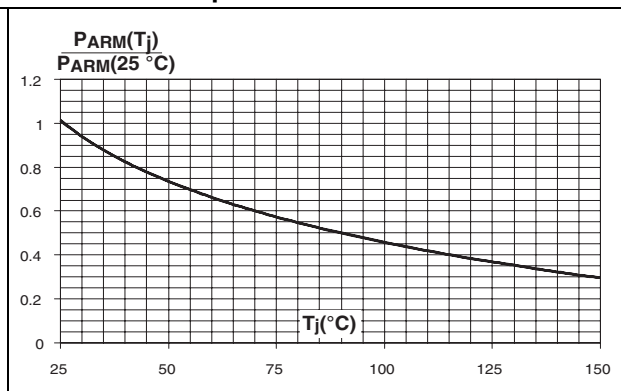

Figure 6. Non repetitive surge peak forward current versus overload duration (maximum values)

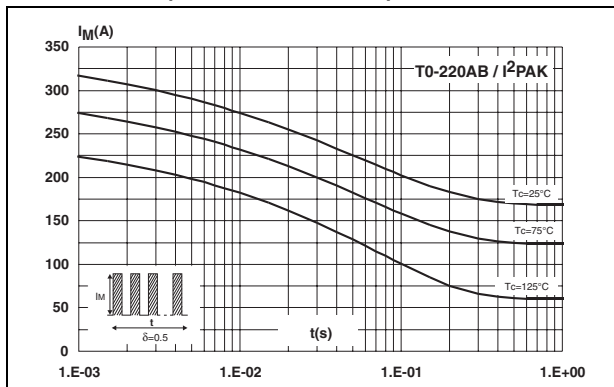
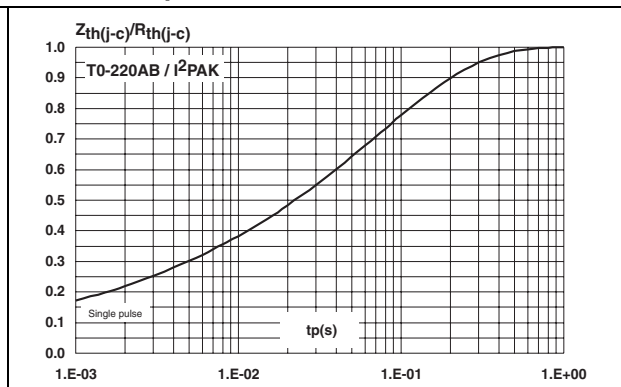
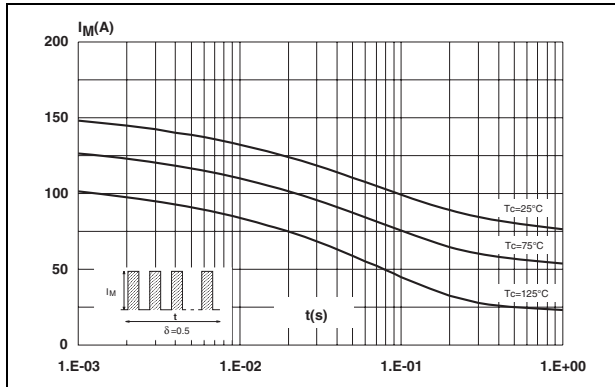

Figure 7. Relative variation of thermal impedance junction to case versus pulse duration



**Figure 8. Non repetitive surge peak forward current versus overload duration (maximum values) (TO-220FPAB)**



**Figure 9. Relative variation of thermal impedance junction to case versus pulse duration (TO-220FPAB)**

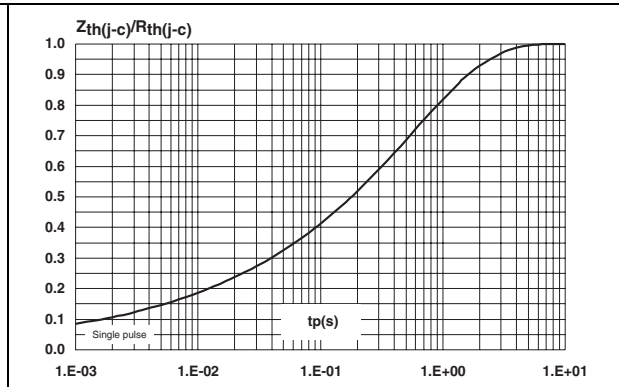

**Figure 10. Reverse leakage current versus reverse voltage applied (typical values)**

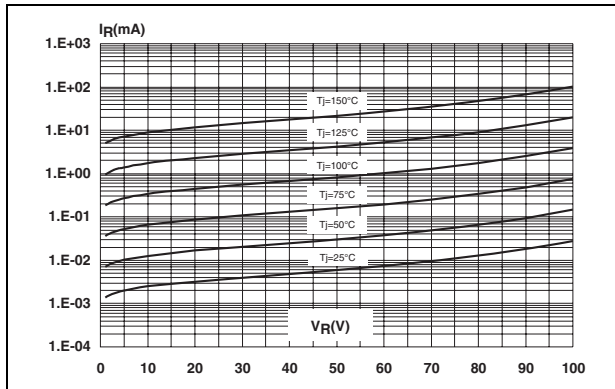

**Figure 11. Junction capacitance versus reverse voltage applied (typical values)**

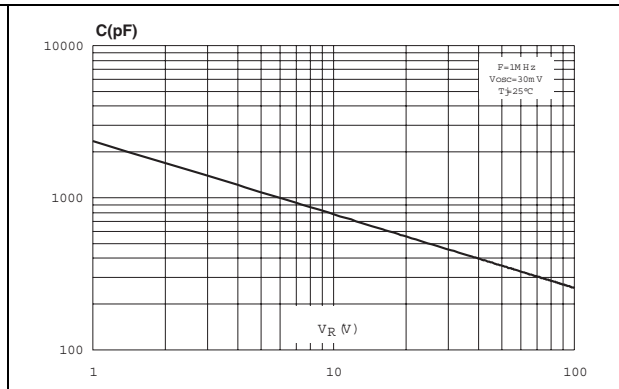

**Figure 12. Forward voltage drop versus forward current (high level)**

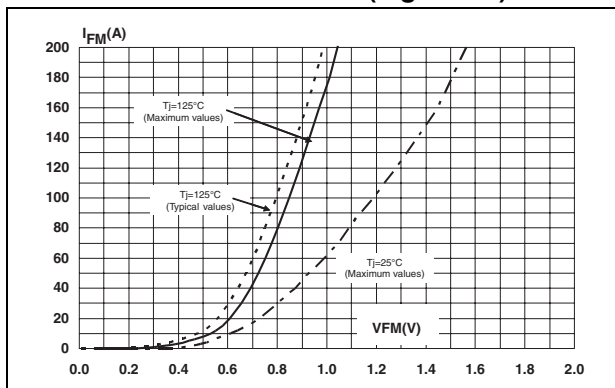

**Figure 13. Forward voltage drop versus forward current (low level)**

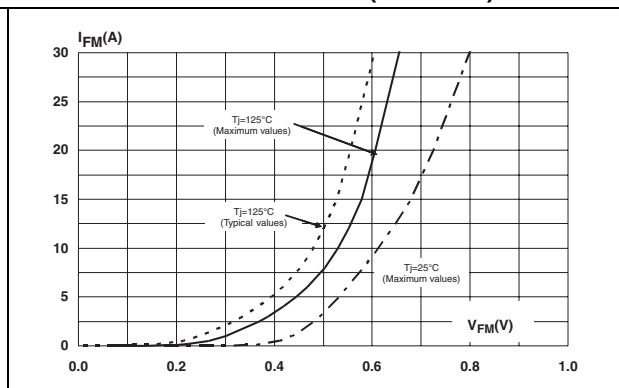
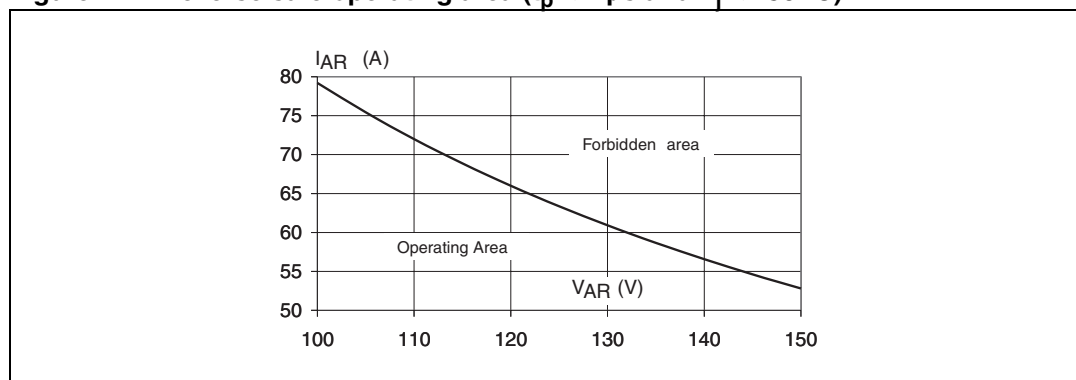

Figure 14. Reverse safe operating area ( $t_p < 1 \mu s$  and  $T_j < 150 \text{ }^\circ\text{C}$ )



## 2 Package Information

- Epoxy meets UL94,V0
- Recommended torque: 0.4 to 0.6 N·m

In order to meet environmental requirements, ST offers these devices in different grades of ECOPACK® packages, depending on their level of environmental compliance. ECOPACK® specifications, grade definitions and product status are available at: [www.st.com](http://www.st.com). ECOPACK® is an ST trademark.

**Table 5. TO-220AB dimensions**

Ref.	Dimensions			
	Millimeters		Inches	
	Min.	Max.	Min.	Max.
A	4.40	4.60	0.173	0.181
C	1.23	1.32	0.048	0.051
D	2.40	2.72	0.094	0.107
E	0.49	0.70	0.019	0.027
F	0.61	0.88	0.024	0.034
F1	1.14	1.70	0.044	0.066
F2	1.14	1.70	0.044	0.066
G	4.95	5.15	0.194	0.202
G1	2.40	2.70	0.094	0.106
H2	10	10.40	0.393	0.409
L2	16.4 typ.		0.645 typ.	
L4	13	14	0.511	0.551
L5	2.65	2.95	0.104	0.116
L6	15.25	15.75	0.600	0.620
L7	6.20	6.60	0.244	0.259
L9	3.50	3.93	0.137	0.154
M	2.6 typ.		0.102 typ.	
Diam.	3.75	3.85	0.147	0.151

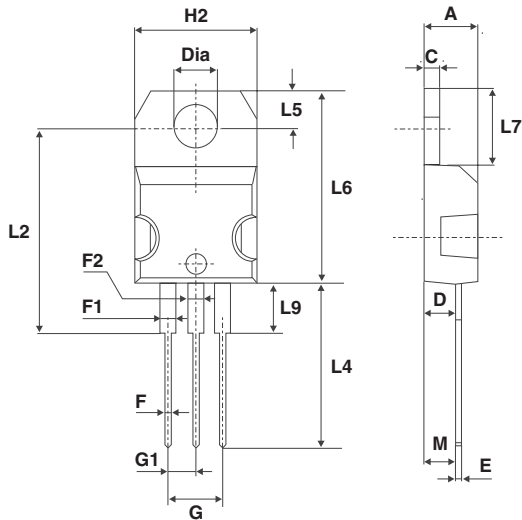

Table 6. TO-220FPAB dimensions

Ref.	Dimensions			
	Millimeters		Inches	
	Min.	Max.	Min.	Max.
A	4.4	4.6	0.173	0.181
B	2.5	2.7	0.098	0.106
D	2.5	2.75	0.098	0.108
E	0.45	0.70	0.018	0.027
F	0.75	1	0.030	0.039
F1	1.15	1.70	0.045	0.067
F2	1.15	1.70	0.045	0.067
G	4.95	5.20	0.195	0.205
G1	2.4	2.7	0.094	0.106
H	10	10.4	0.393	0.409
L2	16 Typ.		0.63 Typ.	
L3	28.6	30.6	1.126	1.205
L4	9.8	10.6	0.386	0.417
L5	2.9	3.6	0.114	0.142
L6	15.9	16.4	0.626	0.646
L7	9.00	9.30	0.354	0.366
Dia.	3.00	3.20	0.118	0.126

Devices in I<sup>2</sup>PAK with nickel-plated back frame must NOT be mounted by frame soldering like SMDs. Such devices are intended to be through-hole mounted ONLY and in no circumstances shall ST be held liable for any lack of performance or damage arising out of soldering of nickel-plated back frames.

**Table 7. I<sup>2</sup>PAK dimensions**

Ref.	Dimensions			
	Millimeters		Inches	
	Min.	Max.	Min.	Max.
A	4.40	4.60	0.173	0.181
A1	2.40	2.72	0.094	0.107
b	0.61	0.88	0.024	0.035
b1	1.14	1.70	0.044	0.067
c	0.49	0.70	0.019	0.028
c2	1.23	1.32	0.048	0.052
D	8.95	9.35	0.352	0.368
e	2.40	2.70	0.094	0.106
e1	4.95	5.15	0.195	0.203
E	10	10.40	0.394	0.409
L	13	14	0.512	0.551
L1	3.50	3.93	0.138	0.155
L2	1.27	1.40	0.050	0.055

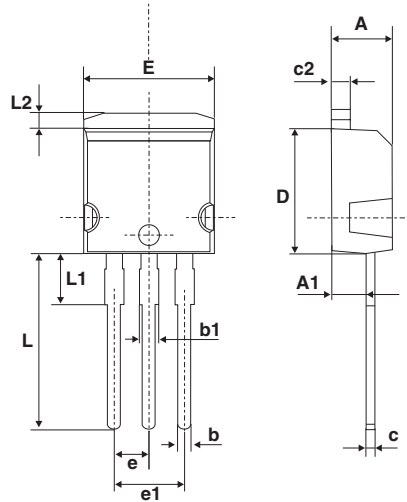



### 3 Ordering information

**Table 8. Ordering information**

Order code	Marking	Package	Weight	Base qty	Delivery mode
STPS30M100ST	STPS30M100ST	TO-220AB	2.3 g	50	Tube
STPS30M100SFP	STPS30M100SFP	TO-220FPAB	2.0 g	50	Tube
STPS30M100SR	STPS30M100SR	I <sup>2</sup> PAK	1.49 g	50	Tube

### 4 Revision history

**Table 9. Document revision history**

Date	Revision	Changes
25-Mar-2009	1	First issue
15-Apr-2010	2	Updated package graphic on front page. Updated <a href="#">Table 3</a> , <a href="#">Table 5</a> , <a href="#">Table 6</a> , and <a href="#">Table 7</a> .
28-Jan-2011	3	Added warning paragraph above <a href="#">Table 7</a> .

**Please Read Carefully:**

Information in this document is provided solely in connection with ST products. STMicroelectronics NV and its subsidiaries ("ST") reserve the right to make changes, corrections, modifications or improvements, to this document, and the products and services described herein at any time, without notice.

All ST products are sold pursuant to ST's terms and conditions of sale.

Purchasers are solely responsible for the choice, selection and use of the ST products and services described herein, and ST assumes no liability whatsoever relating to the choice, selection or use of the ST products and services described herein.

No license, express or implied, by estoppel or otherwise, to any intellectual property rights is granted under this document. If any part of this document refers to any third party products or services it shall not be deemed a license grant by ST for the use of such third party products or services, or any intellectual property contained therein or considered as a warranty covering the use in any manner whatsoever of such third party products or services or any intellectual property contained therein.

**UNLESS OTHERWISE SET FORTH IN ST'S TERMS AND CONDITIONS OF SALE ST DISCLAIMS ANY EXPRESS OR IMPLIED WARRANTY WITH RESPECT TO THE USE AND/OR SALE OF ST PRODUCTS INCLUDING WITHOUT LIMITATION IMPLIED WARRANTIES OF MERCHANTABILITY, FITNESS FOR A PARTICULAR PURPOSE (AND THEIR EQUIVALENTS UNDER THE LAWS OF ANY JURISDICTION), OR INFRINGEMENT OF ANY PATENT, COPYRIGHT OR OTHER INTELLECTUAL PROPERTY RIGHT.**

**UNLESS EXPRESSLY APPROVED IN WRITING BY AN AUTHORIZED ST REPRESENTATIVE, ST PRODUCTS ARE NOT RECOMMENDED, AUTHORIZED OR WARRANTED FOR USE IN MILITARY, AIR CRAFT, SPACE, LIFE SAVING, OR LIFE SUSTAINING APPLICATIONS, NOR IN PRODUCTS OR SYSTEMS WHERE FAILURE OR MALFUNCTION MAY RESULT IN PERSONAL INJURY, DEATH, OR SEVERE PROPERTY OR ENVIRONMENTAL DAMAGE. ST PRODUCTS WHICH ARE NOT SPECIFIED AS "AUTOMOTIVE GRADE" MAY ONLY BE USED IN AUTOMOTIVE APPLICATIONS AT USER'S OWN RISK.**

Resale of ST products with provisions different from the statements and/or technical features set forth in this document shall immediately void any warranty granted by ST for the ST product or service described herein and shall not create or extend in any manner whatsoever, any liability of ST.

ST and the ST logo are trademarks or registered trademarks of ST in various countries.

Information in this document supersedes and replaces all information previously supplied.

The ST logo is a registered trademark of STMicroelectronics. All other names are the property of their respective owners.

© 2011 STMicroelectronics - All rights reserved

STMicroelectronics group of companies

Australia - Belgium - Brazil - Canada - China - Czech Republic - Finland - France - Germany - Hong Kong - India - Israel - Italy - Japan - Malaysia - Malta - Morocco - Philippines - Singapore - Spain - Sweden - Switzerland - United Kingdom - United States of America

[www.st.com](http://www.st.com)