



General Description

AFP4447, P-Channel enhancement mode MOSFET, uses Advanced Trench Technology to provide excellent $R_{DS(ON)}$, low gate charge.

These devices are particularly suited for low voltage power management, and low in-line power loss are needed in commercial industrial surface mount applications.

Features

- -40V/ -10A, $R_{DS(ON)} = 40m\Omega @ V_{GS} = -10V$
- -40V/ -8A, $R_{DS(ON)} = 55m\Omega @ V_{GS} = -4.5V$
- Super high density cell design for extremely low $R_{DS(ON)}$
- TO-252-2L package design

Pin Description (TO-252-2L)

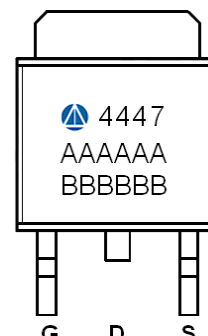
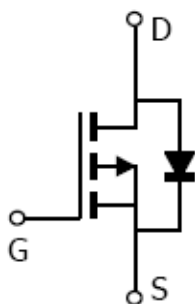
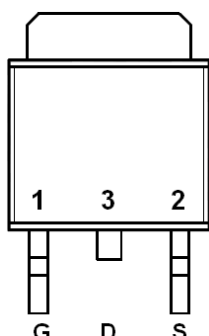

Application

- Backlight Inverter for LCD Display
- Full Bridge DC/DC Converter
- LED Display
- Load Switch
- CCFL Inverter

Pin Define

Pin	Symbol	Description
1	G	Gate
2	S	Source
3	D	Drain

Ordering Information

Part Ordering No.	Part Marking	Package	Unit	Quantity
AFP4447T252RG	4447	TO-252-2L	Tape & Reel	2500 EA

※ A Lot code

※ B Date code

※ AFP4447T252RG : 13" Tape & Reel ; Pb- Free ; Halogen- Free



Absolute Maximum Ratings

($T_A=25^{\circ}\text{C}$ Unless otherwise noted)

Parameter	Symbol	Typical	Unit
Drain-Source Voltage	V_{DSS}	-40	V
Gate -Source Voltage	V_{GSS}	± 20	V
Continuous Drain Current ($T_J=150^{\circ}\text{C}$)	I_D	$T_A=25^{\circ}\text{C}$	-22
		$T_A=70^{\circ}\text{C}$	-16
Pulsed Drain Current	I_{DM}	-30	A
Continuous Source-Drain Diode Current	I_S	-8	A
Single Pulse Avalanche Current	I_{AS}	-30	A
Avalanche Energy	E_{AS}	35	mJ
Power Dissipation	P_D	$T_A=25^{\circ}\text{C}$	40
		$T_A=70^{\circ}\text{C}$	15
Operating Junction Temperature	T_J	150	$^{\circ}\text{C}$
Storage Temperature Range	T_{STG}	-55/150	$^{\circ}\text{C}$
Thermal Resistance-Junction to Ambient	$R_{\theta JA}$	62.5	$^{\circ}\text{C}/\text{W}$

Electrical Characteristics

($T_A=25^{\circ}\text{C}$ Unless otherwise noted)

Parameter	Symbol	Conditions	Min.	Typ	Max.	Unit
Static						
Drain-Source Breakdown Voltage	$V_{(BR)DSS}$	$V_{GS}=0\text{V}, I_D = -250\mu\text{A}$	-40			V
Gate Threshold Voltage	$V_{GS(th)}$	$V_{DS}=V_{GS}, I_D = -250\mu\text{A}$	-1.0		-3.0	
Gate Leakage Current	I_{GSS}	$V_{DS}=0\text{V}, V_{GS} = \pm 20\text{V}$			± 100	nA
Zero Gate Voltage Drain Current	I_{DSS}	$V_{DS} = -40\text{V}, V_{GS}=0\text{V}$			-1	uA
		$V_{DS} = -40\text{V}, V_{GS}=0\text{V}$ $T_J=85^{\circ}\text{C}$			-20	
On-State Drain Current	$I_{D(on)}$	$V_{DS} \geq -5\text{V}, V_{GS} = -10\text{V}$	-20			A
Drain-Source On-Resistance	$R_{DS(on)}$	$V_{GS} = -10\text{V}, I_D = -10\text{A}$		30	40	m Ω
		$V_{GS} = -4.5\text{V}, I_D = -8\text{A}$		42	55	
Forward Transconductance	g_{FS}	$V_{DS} = -15\text{V}, I_D = -5\text{A}$		20		S
Diode Forward Voltage	V_{SD}	$I_S = -2\text{A}, V_{GS}=0\text{V}$		-0.8	-1.2	V
Dynamic						
Total Gate Charge	Q_g	$V_{DS} = -20\text{V}, V_{GS} = -4.5\text{V}$ $I_D = -5.0\text{A}$		11	18	nC
Gate-Source Charge	Q_{gs}			3.5		
Gate-Drain Charge	Q_{gd}			5.5		
Input Capacitance	C_{iss}	$V_{DS} = -20\text{V}, V_{GS}=0\text{V}$ $f=1\text{MHz}$		970		pF
Output Capacitance	C_{oss}			120		
Reverse Transfer Capacitance	C_{rss}			95		
Turn-On Time	$t_{d(on)}$	$V_{DD} = -20\text{V}, R_L = 4\Omega$ $I_D = -5.0\text{A}, V_{GEN} = -4.5\text{V}$ $R_G = 1\Omega$		40	80	ns
	t_r			35	65	
Turn-Off Time	$t_{d(off)}$			30	55	
	t_f			13	25	



Typical Characteristics

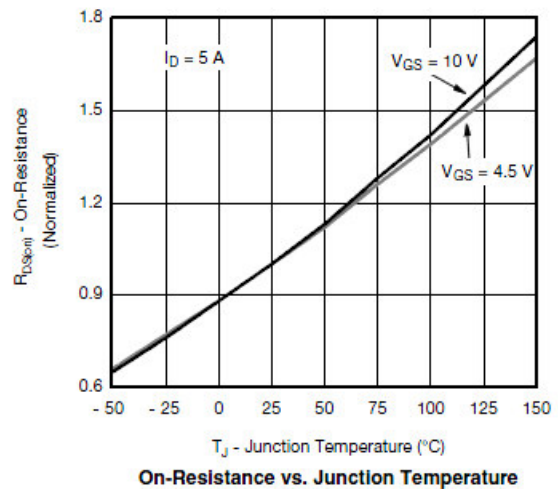
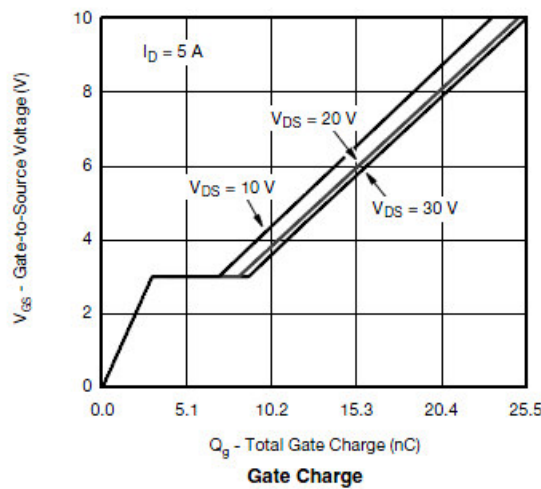
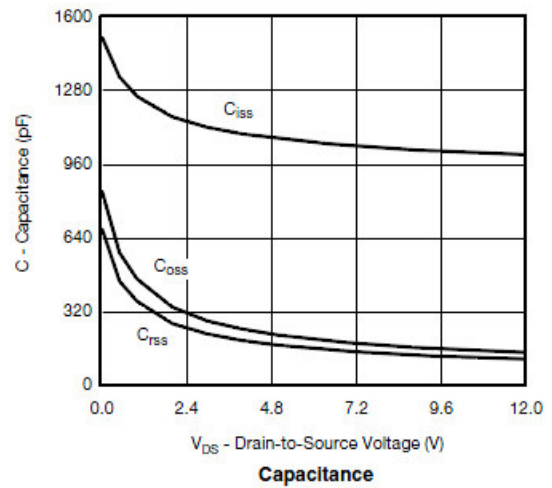
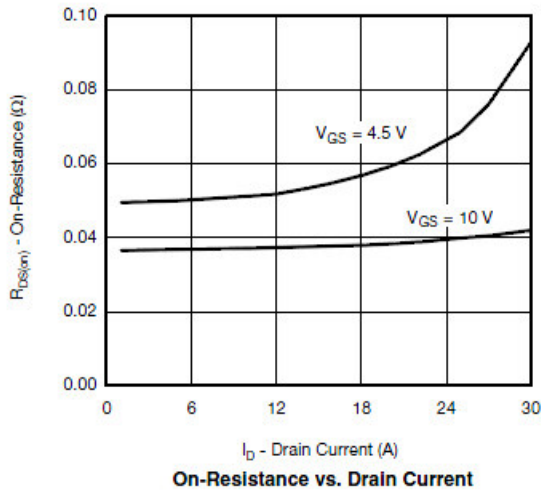
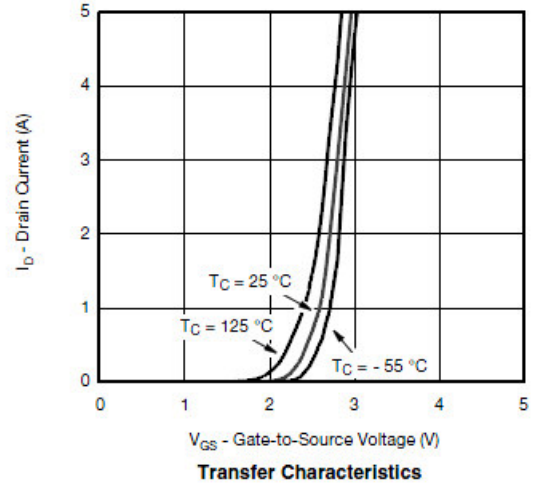
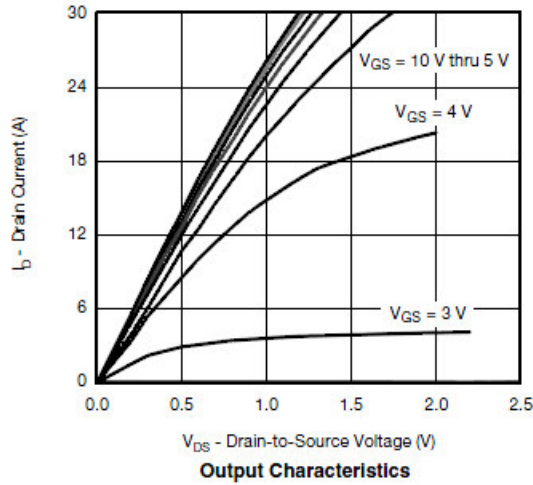



Typical Characteristics

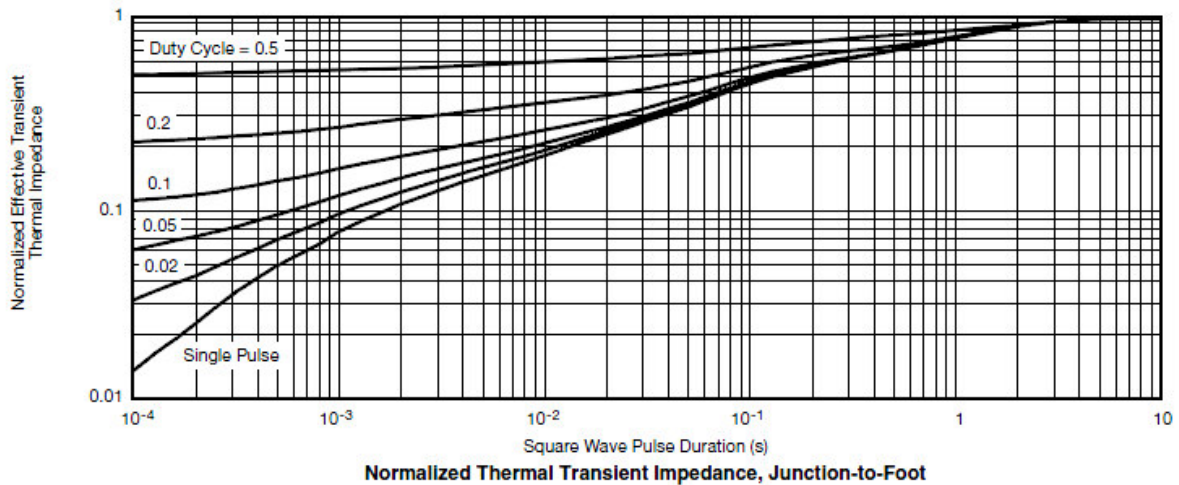
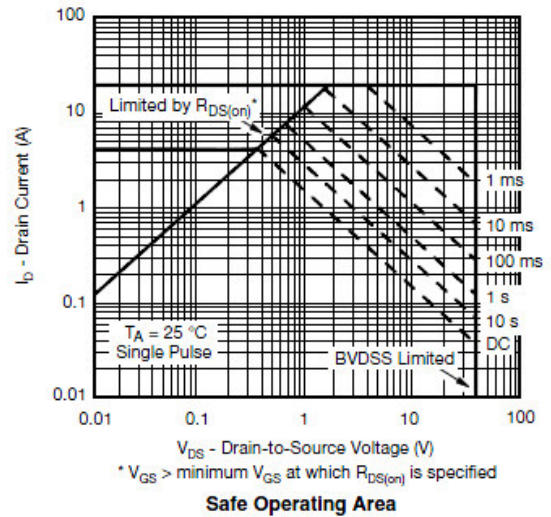
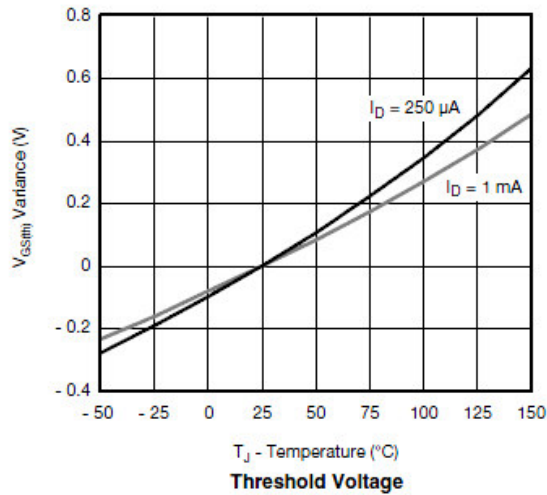
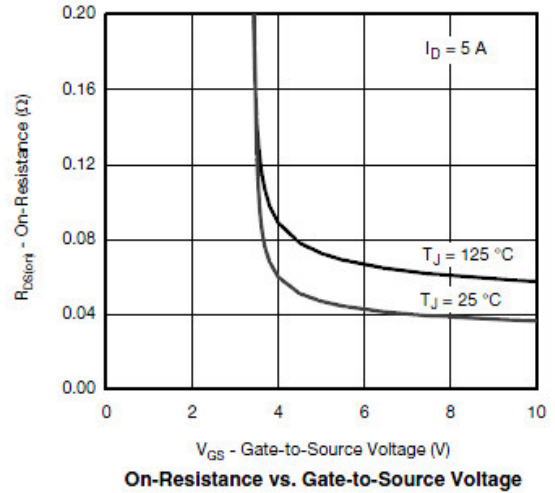
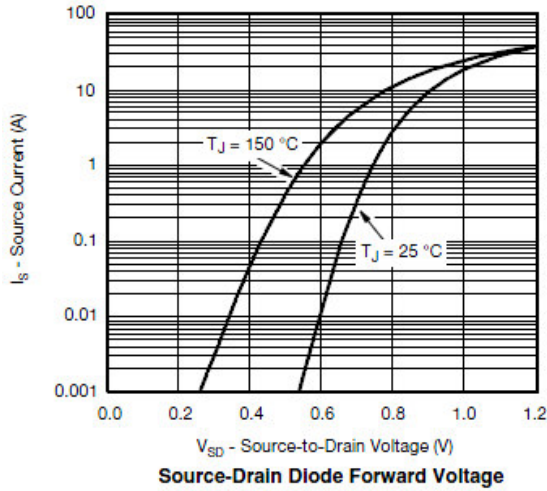



Typical Characteristics

Gate Charge Test Circuit & Waveform

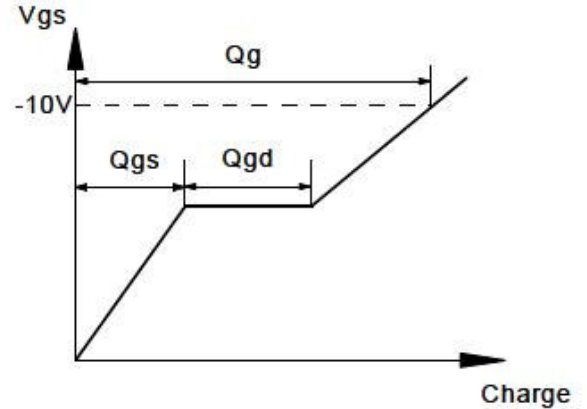
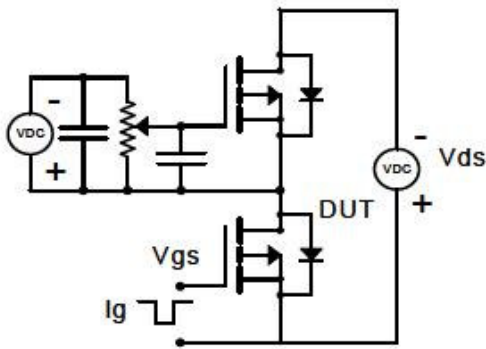

Resistive Switching Test Circuit & Waveforms

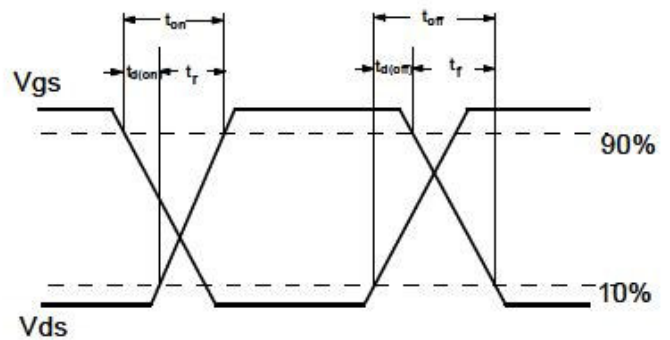
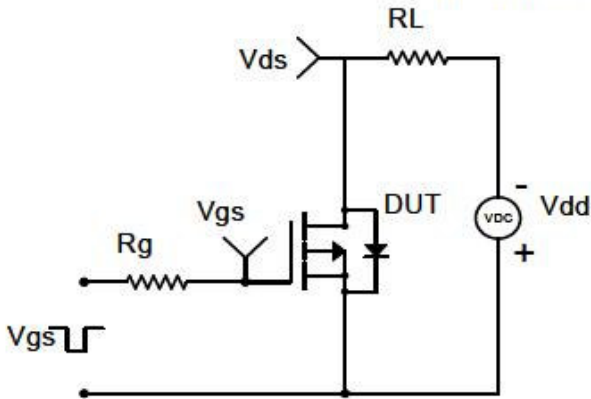

Diode Recovery Test Circuit & Waveforms

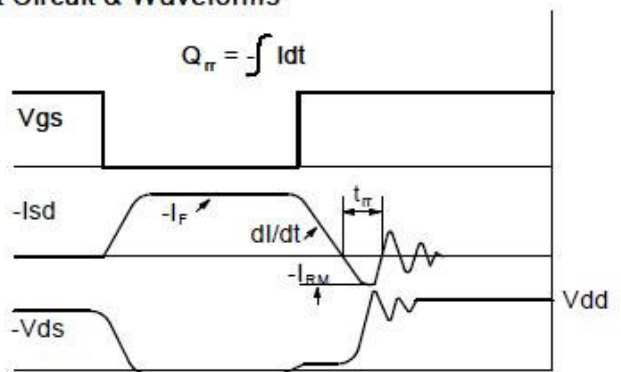
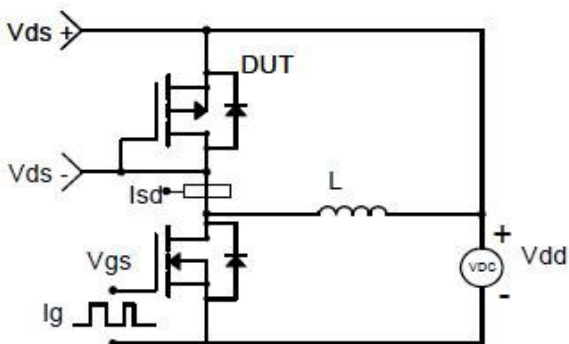



Package Information (TO-252-2L)

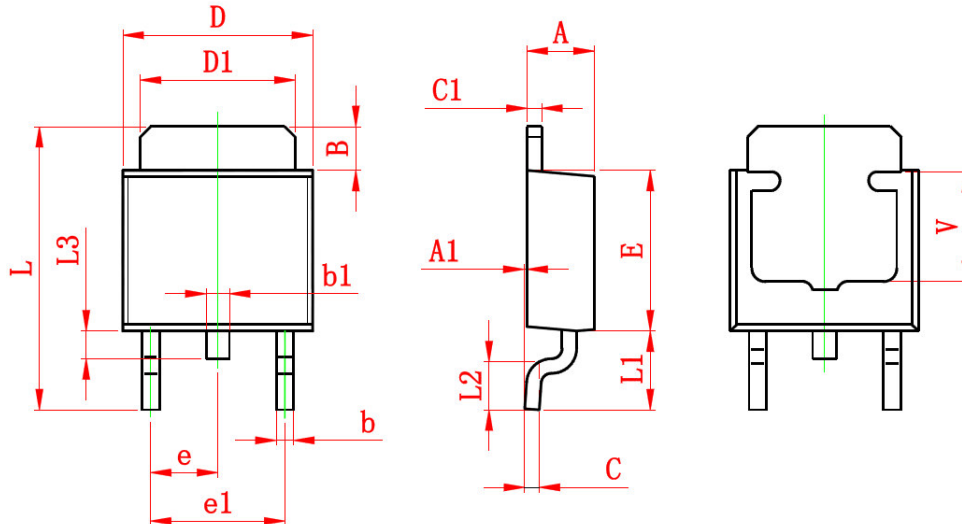

Symbol	Dimensions In Millimeters		Dimensions In Inches	
	Min.	Max.	Min.	Max.
A	2.200	2.400	0.087	0.094
A1	0.000	0.127	0.000	0.005
B	1.350	1.650	0.053	0.065
b	0.500	0.700	0.020	0.028
b1	0.700	0.900	0.028	0.035
c	0.430	0.580	0.017	0.023
c1	0.430	0.580	0.017	0.023
D	6.350	6.650	0.250	0.262
D1	5.200	5.400	0.205	0.213
E	5.400	5.700	0.213	0.224
e	2.300 TYP.		0.091 TYP.	
e1	4.500	4.700	0.177	0.185
L	9.500	9.900	0.374	0.390
L1	2.550	2.900	0.100	0.114
L2	1.400	1.780	0.055	0.070
L3	0.600	0.900	0.024	0.035
V	3.800 REF.		0.150 REF.	

©2010 Alfa-MOS Technology Corp.
 2F, No.80, Sec.1, Cheng Kung Rd., Nan Kang Dist., Taipei City 115, Taiwan (R.O.C.)
 Tel : 886 2) 2651 3928
 Fax : 886 2) 2786 8483
 ©http://www.alfa-mos.com