



## General Description

AFP3981, P-Channel enhancement mode MOSFET, uses Advanced Trench Technology to provide excellent  $R_{DS(ON)}$ , low gate charge.

These devices are particularly suited for low voltage power management, such as smart phone and notebook computer and other battery powered circuits, and low in-line power loss are needed in commercial industrial surface mount applications.

## Features

- -20V/-3.2A,  $R_{DS(ON)}=100m\Omega@V_{GS}=-4.5V$
- -20V/-2.4A,  $R_{DS(ON)}=135m\Omega@V_{GS}=-2.5V$
- -20V/-1.5A,  $R_{DS(ON)}=190m\Omega@V_{GS}=-1.8V$
- Super high density cell design for extremely low  $R_{DS(ON)}$
- Exceptional on-resistance and maximum DC current capability
- TSOP-6 package design

## Pin Description ( TSOP-6 )

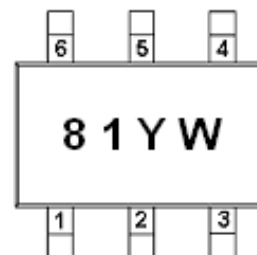
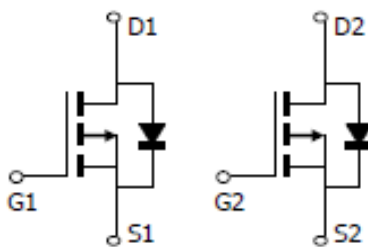
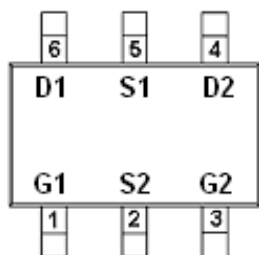

## Application

- Power Management in Note book
- Portable Equipment
- Battery Powered System
- Net Working System

## Pin Define

Pin	Symbol	Description
1	G1	Source 1
2	S2	Gate 1
3	G2	Drain 2
4	D2	Source 2
5	S1	Gate 2
6	D1	Drain1

## Ordering Information

Part Ordering No.	Part Marking	Package	Unit	Quantity
AFP3981TS6RG	81YW	TSOP-6	Tape & Reel	3000 EA

- ※ 81 parts code
- ※ Y year code ( 0 ~ 9 )
- ※ W week code ( A ~ Z = 1 ~ 26 / a ~ z = 27 ~ 52 )
- ※ AFP3981TS6RG : 7" Tape & Reel ; Pb- Free ; Halogen- Free



## Absolute Maximum Ratings

(T<sub>A</sub>=25°C Unless otherwise noted)

Parameter	Symbol	Typical	Unit
Drain-Source Voltage	V <sub>DSS</sub>	-20	V
Gate –Source Voltage	V <sub>GSS</sub>	±12	V
Continuous Drain Current(T <sub>J</sub> =150°C)	I <sub>D</sub>	T <sub>A</sub> =25°C	-3.2
		T <sub>A</sub> =70°C	-2.6
Pulsed Drain Current	I <sub>DM</sub>	-20	A
Continuous Source Current(Diode Conduction)	I <sub>S</sub>	-1.7	A
Power Dissipation	P <sub>D</sub>	T <sub>A</sub> =25°C	2.0
		T <sub>A</sub> =70°C	1.3
Operating Junction Temperature	T <sub>J</sub>	150	°C
Storage Temperature Range	T <sub>STG</sub>	-55/150	°C
Thermal Resistance-Junction to Ambient	R <sub>θJA</sub>	120	°C/W

## Electrical Characteristics

(T<sub>A</sub>=25°C Unless otherwise noted)

Parameter	Symbol	Conditions	Min.	Typ	Max.	Unit
<b>Static</b>						
Drain-Source Breakdown Voltage	V <sub>(BR)DSS</sub>	V <sub>GS</sub> =0V, I <sub>D</sub> =-250uA	-20			V
Gate Threshold Voltage	V <sub>GS(th)</sub>	V <sub>DS</sub> =V <sub>GS</sub> , I <sub>D</sub> =-250uA	-0.3		-0.7	
Gate Leakage Current	I <sub>GSS</sub>	V <sub>DS</sub> =0V, V <sub>GS</sub> =±12V			±100	nA
Zero Gate Voltage Drain Current	I <sub>DSS</sub>	V <sub>DS</sub> =-16V, V <sub>GS</sub> =0V			-1	uA
		V <sub>DS</sub> =-16V, V <sub>GS</sub> =0V T <sub>J</sub> =85°C			-30	
On-State Drain Current	I <sub>D(on)</sub>	V <sub>DS</sub> ≤ -5V, V <sub>GS</sub> =-4.5V	-6			A
		V <sub>DS</sub> ≤ -5V, V <sub>GS</sub> =-2.5V	-3			
Drain-Source On-Resistance	R <sub>DS(on)</sub>	V <sub>GS</sub> =-4.5V, I <sub>D</sub> =-3.2A		92	100	mΩ
		V <sub>GS</sub> =-2.5V, I <sub>D</sub> =-2.6A		122	135	
		V <sub>GS</sub> =-1.8V, I <sub>D</sub> =-1.5A		168	190	
Forward Transconductance	g <sub>FS</sub>	V <sub>DS</sub> =-5V, I <sub>D</sub> =-2.8A		6.5		S
Diode Forward Voltage	V <sub>SD</sub>	I <sub>S</sub> =-1.25A, V <sub>GS</sub> =0V		-0.75	-1.3	V
<b>Dynamic</b>						
Total Gate Charge	Q <sub>g</sub>	V <sub>DS</sub> =-6V, V <sub>GS</sub> =-4.5V I <sub>D</sub> =-2.8A		5.8	10	nC
Gate-Source Charge	Q <sub>gs</sub>			0.85		
Gate-Drain Charge	Q <sub>gd</sub>			1.7		
Input Capacitance	C <sub>iss</sub>	V <sub>DS</sub> =-6V, V <sub>GS</sub> =0V f=1MHz		415		pF
Output Capacitance	C <sub>oss</sub>			223		
Reverse Transfer Capacitance	C <sub>rss</sub>			87		
Turn-On Time	t <sub>d(on)</sub>	V <sub>DD</sub> =-6V, R <sub>L</sub> =6Ω I <sub>D</sub> =-1.0A, V <sub>GEN</sub> =-4.5V R <sub>G</sub> =6Ω		13	25	ns
	t <sub>r</sub>			36	60	
Turn-Off Time	t <sub>d(off)</sub>			42	70	
	t <sub>f</sub>			34	60	



## Typical Characteristics

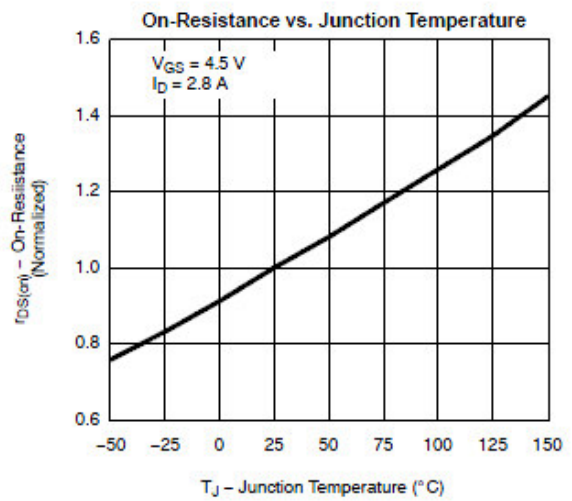
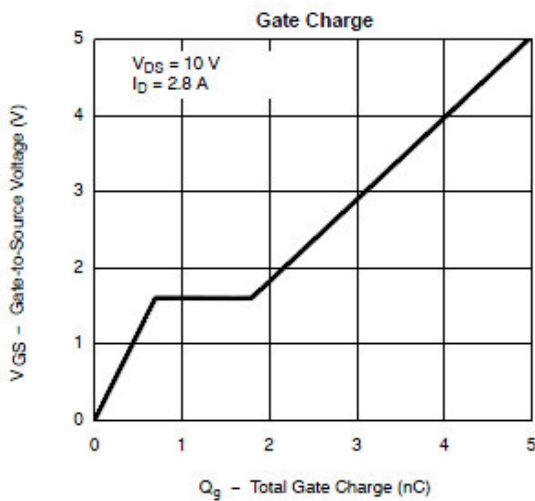
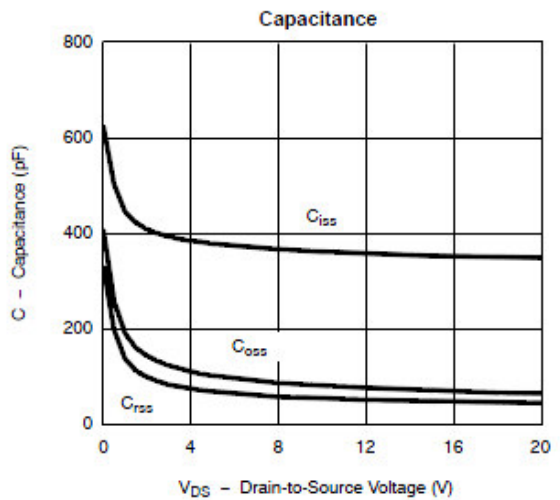
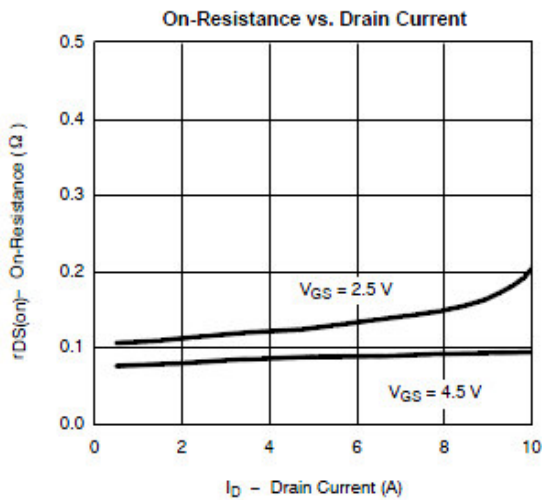
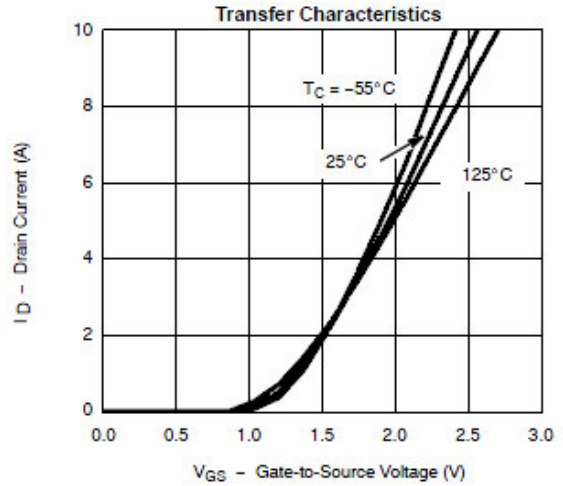
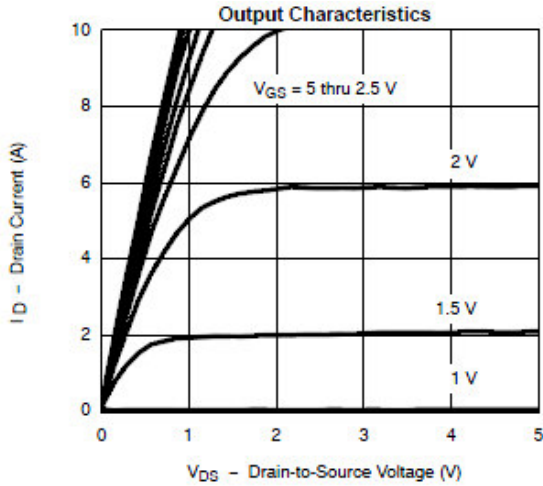



## Typical Characteristics

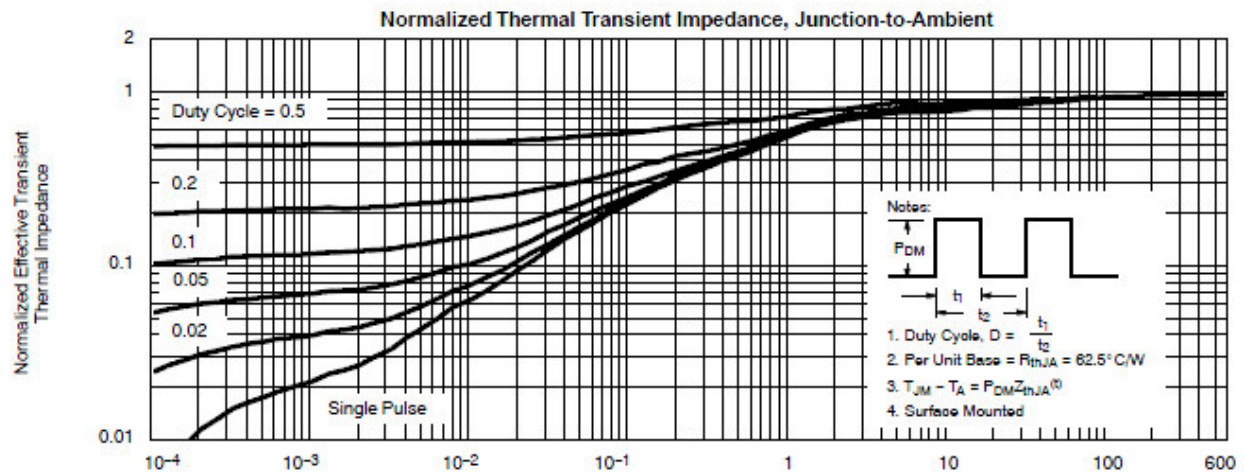
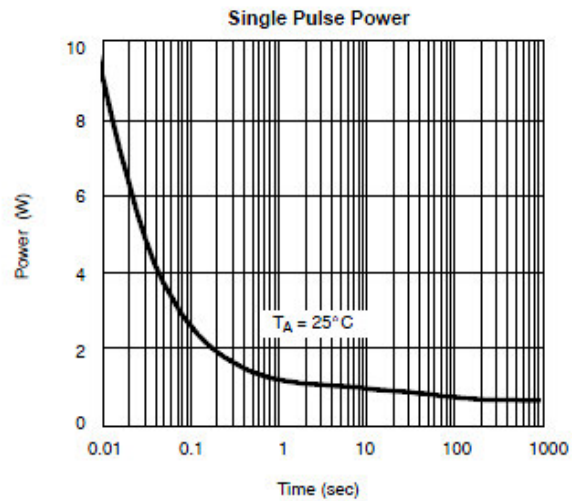
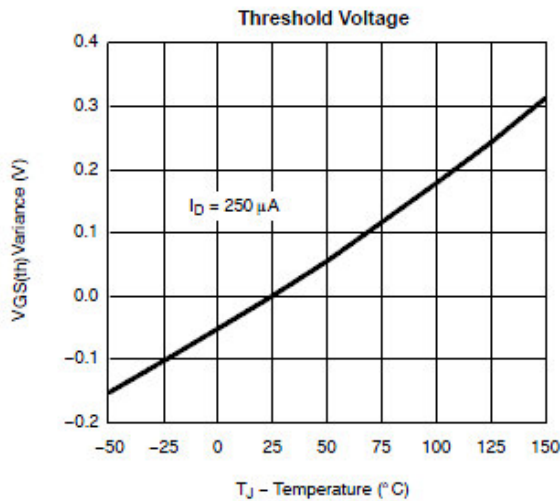
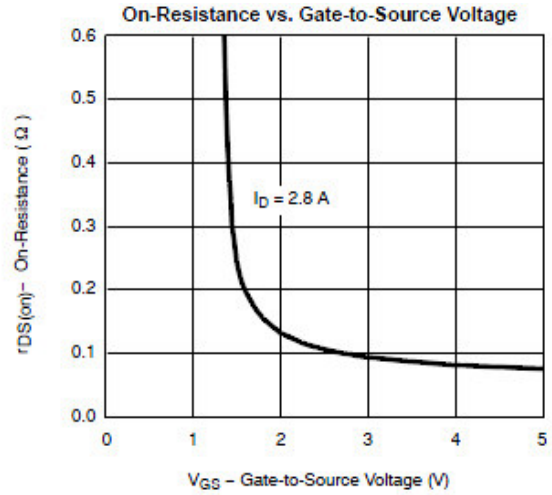
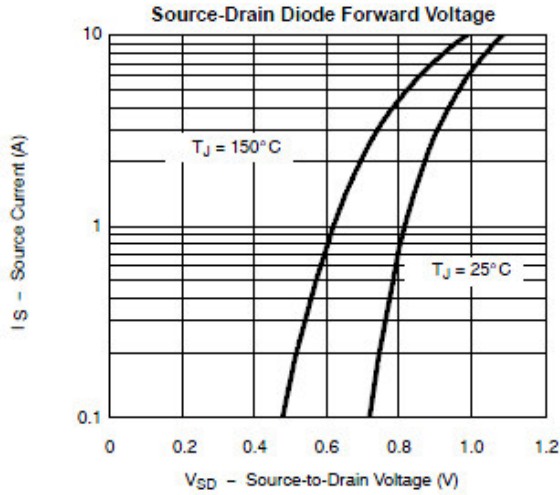



**Typical Characteristics**

Gate Charge Test Circuit & Waveform

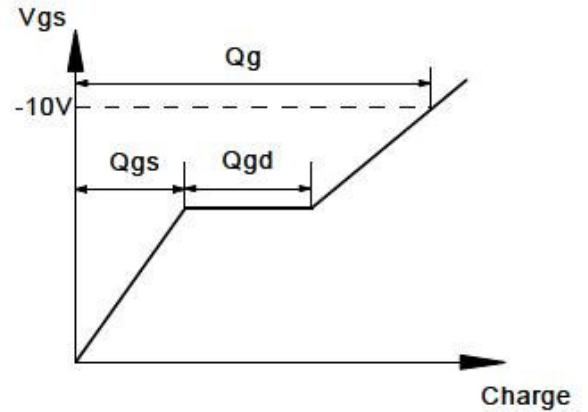
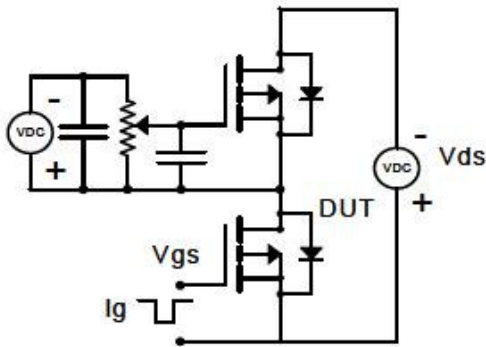

Resistive Switching Test Circuit & Waveforms

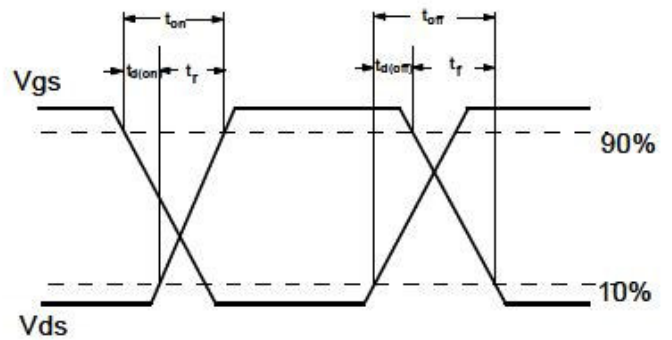
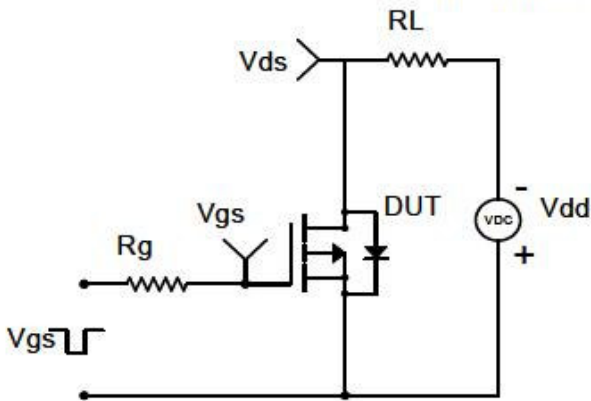

Diode Recovery Test Circuit & Waveforms

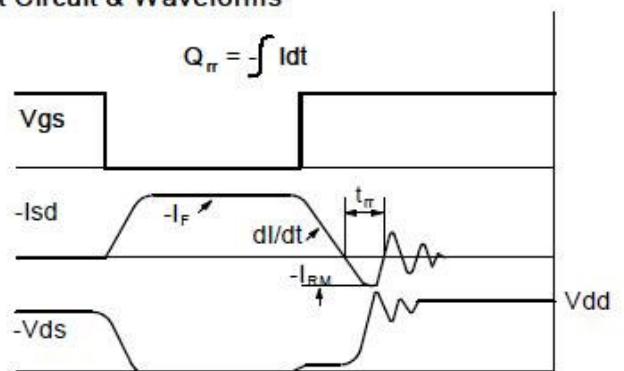
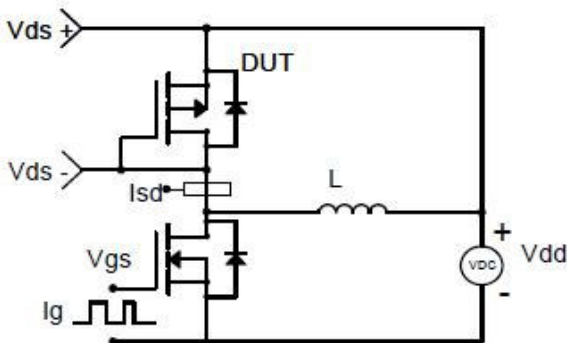



**Package Information ( TSOP-6 )**

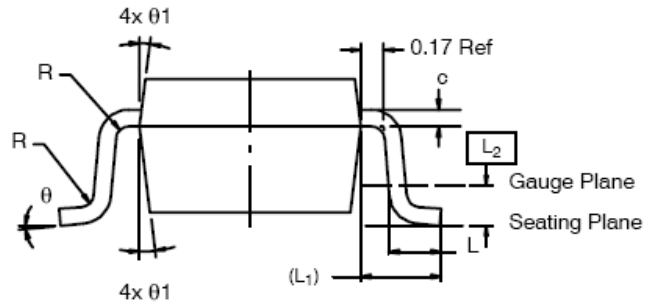
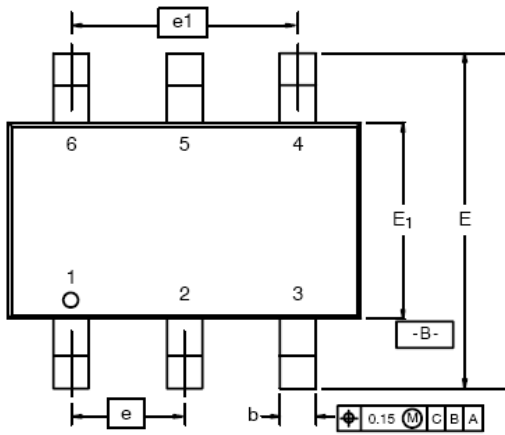

Dim	MILLIMETERS			INCHES		
	Min	Nom	Max	Min	Nom	Max
A	0.91	-	1.10	0.036	-	0.043
A <sub>1</sub>	0.01	-	0.10	0.0004	-	0.004
A <sub>2</sub>	0.90	-	1.00	0.035	0.038	0.039
b	0.30	0.32	0.45	0.012	0.013	0.018
c	0.10	0.15	0.20	0.004	0.006	0.008
D	2.95	3.05	3.10	0.116	0.120	0.122
E	2.70	2.85	2.96	0.106	0.112	0.117
E <sub>1</sub>	1.55	1.65	1.70	0.061	0.065	0.067
e	1.00 BSC			0.0394 BSC		
e <sub>1</sub>	1.90	2.00	2.10	0.075	0.080	0.085
L	0.35	-	0.50	0.014	-	0.020
L <sub>1</sub>	0.60 Ref			0.024 Ref		
L <sub>2</sub>	0.25 BSC			0.010 BSC		
R	0.10	-	-	0.004	-	-
θ	0°	4°	8°	0°	4°	8°
θ <sub>1</sub>	7° Nom			7° Nom		

©2010 Alfa-MOS Technology Corp.  
 2F, No.80, Sec.1, Cheng Kung Rd., Nan Kang Dist., Taipei City 115, Taiwan (R.O.C.)  
 Tel : 886 2) 2651 3928  
 Fax : 886 2) 2786 8483  
 ©http://www.alfa-mos.com