



General Description

AFP3407S, P-Channel enhancement mode MOSFET, uses Advanced Trench Technology to provide excellent $R_{DS(ON)}$, low gate charge.

These devices are particularly suited for low voltage power management, and low in-line power loss are needed in commercial industrial surface mount applications.

Features

- -30V/-3.6A, $R_{DS(ON)}=75m\Omega@V_{GS}=-10.0V$
- -30V/-3.2A, $R_{DS(ON)}=95m\Omega@V_{GS}=-4.5V$
- Super high density cell design for extremely low $R_{DS(ON)}$
- Exceptional on-resistance and maximum DC current capability
- SOT-23-3L package design

Pin Description (SOT-23-3L)

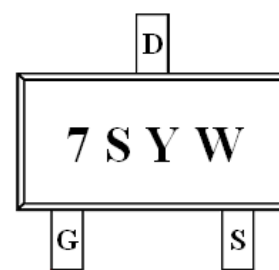
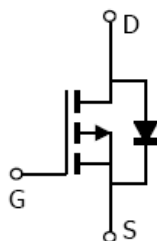
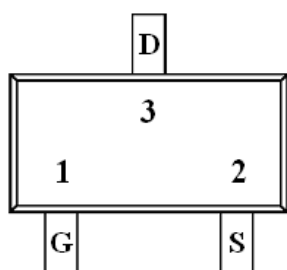

Application

- Power Management in Note book
- LED Display
- DC-DC System
- LCD Panel

Pin Define

Pin	Symbol	Description
1	G	Gate
2	S	Source
3	D	Drain

Ordering Information

Part Ordering No.	Part Marking	Package	Unit	Quantity
AFP3407SS23RG	7SYW	SOT-23-3L	Tape & Reel	3000 EA

- ※ 7S parts code
- ※ Y year code (0 ~ 9)
- ※ W week code (A ~ Z = 1 ~ 26 / a ~ z = 27 ~ 52)
- ※ AFP3407SS23RG : 7" Tape & Reel ; Pb- Free ; Halogen- Free



Absolute Maximum Ratings

(T_A=25°C Unless otherwise noted)

Parameter	Symbol	Typical	Unit
Drain-Source Voltage	V _{DSS}	-30	V
Gate –Source Voltage	V _{GSS}	±20	V
Continuous Drain Current(T _J =150°C)	I _D	T _A =25°C	-3.6
		T _A =70°C	-3.0
Pulsed Drain Current	I _{DM}	-15	A
Continuous Source Current(Diode Conduction)	I _S	-1.5	A
Power Dissipation	P _D	T _A =25°C	1.25
		T _A =70°C	0.8
Operating Junction Temperature	T _J	150	°C
Storage Temperature Range	T _{STG}	-55/150	°C
Thermal Resistance-Junction to Ambient	R _{θJA}	120	°C/W

Electrical Characteristics

(T_A=25°C Unless otherwise noted)

Parameter	Symbol	Conditions	Min.	Typ	Max.	Unit
Static						
Drain-Source Breakdown Voltage	V _{(BR)DSS}	V _{GS} =0V, I _D =-250uA	-30			V
Gate Threshold Voltage	V _{GS(th)}	V _{DS} =V _{GS} , I _D =-250uA	-1.0		-2.5	V
Gate Leakage Current	I _{GSS}	V _{DS} =0V, V _{GS} =±12V			±100	nA
Zero Gate Voltage Drain Current	I _{DSS}	V _{DS} =-24V, V _{GS} =0V			-1	uA
		V _{DS} =-24V, V _{GS} =0V T _A =85°C			-30	
On-State Drain Current	I _{D(on)}	V _{DS} ≤ -5V, V _{GS} =-10V	-10			A
Drain-Source On-Resistance	R _{DS(on)}	V _{GS} =-10.0V, I _D =-3.6A		60	75	mΩ
		V _{GS} =-4.5V, I _D =-3.2A		80	95	
Forward Transconductance	g _{FS}	V _{DS} =-5V, I _D =-4.0A		10		S
Diode Forward Voltage	V _{SD}	I _S =-1.7A, V _{GS} =0V		-0.7	-1.3	V
Dynamic						
Total Gate Charge	Q _g	V _{DS} =-15V, V _{GS} =-10V I _D ≡-3.5A		10	18	nC
Gate-Source Charge	Q _{gs}			1.6		
Gate-Drain Charge	Q _{gd}			3.0		
Input Capacitance	C _{iSS}	V _{DS} =-15V, V _{GS} =0V f=1MHz		450		pF
Output Capacitance	C _{oss}			95		
Reverse Transfer Capacitance	C _{rss}			55		
Turn-On Time	t _{d(on)}	V _{DD} =-15V, R _L =15Ω I _D ≡-1.0A, V _{GEN} =-10V R _G =6Ω		8	18	ns
	t _r			8	18	
Turn-Off Time	t _{d(off)}			25	50	
	t _f			25	35	



Typical Characteristics

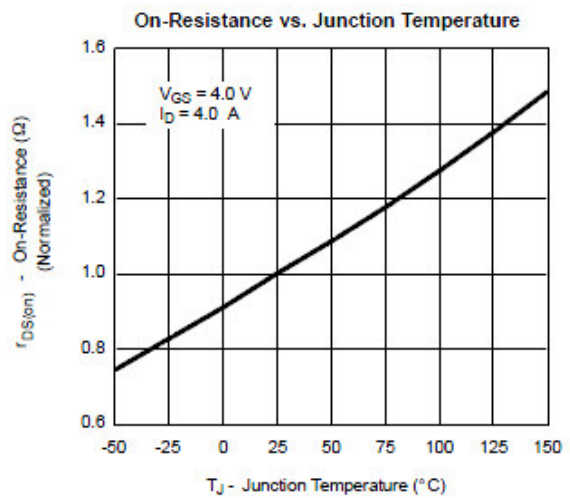
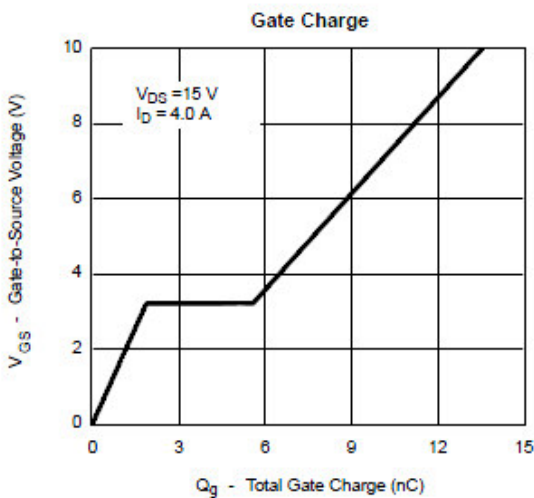
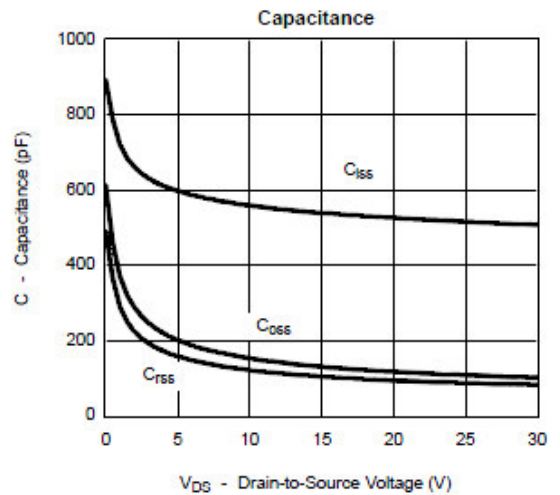
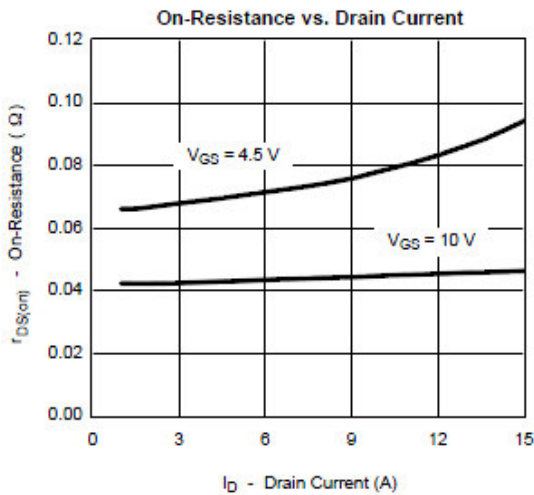
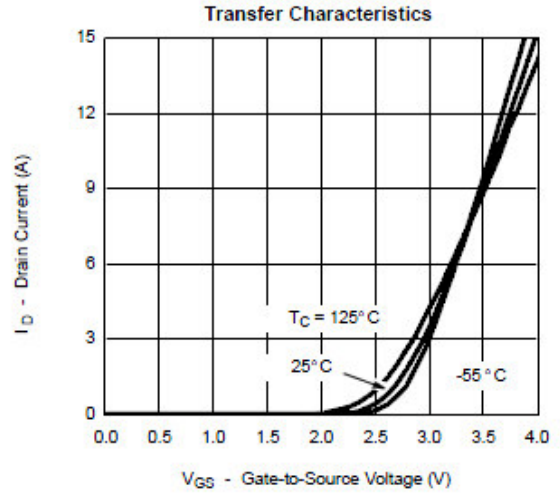
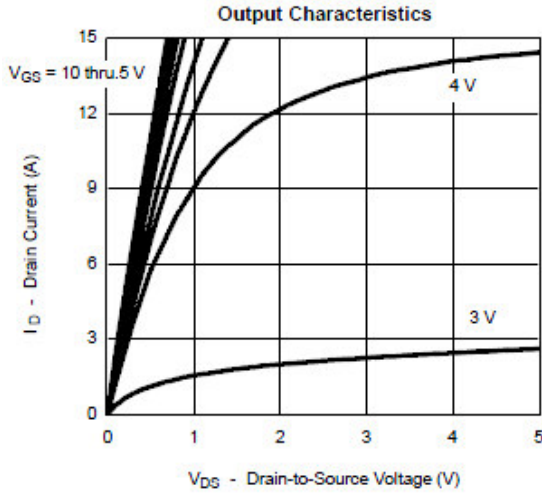



Typical Characteristics

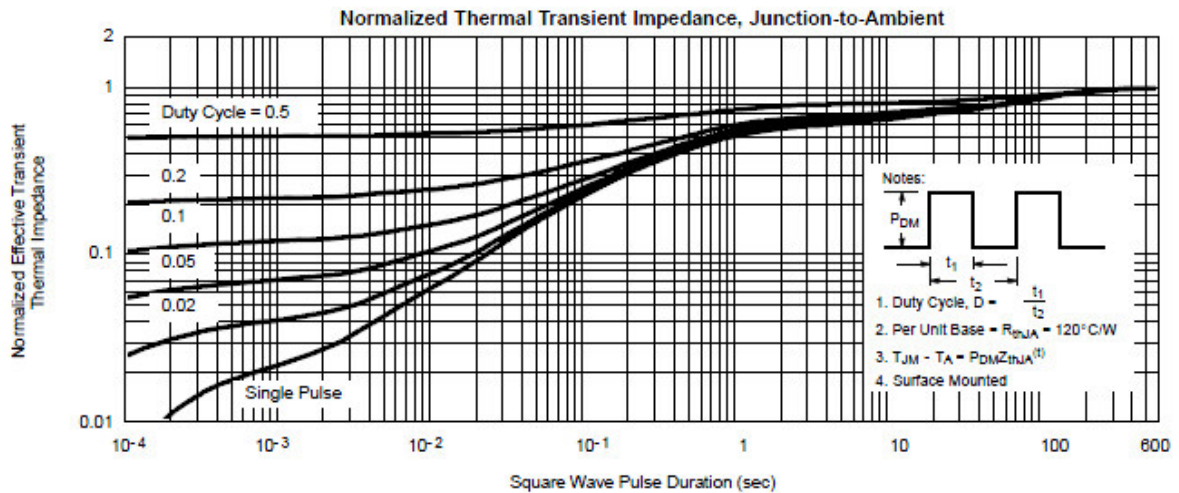
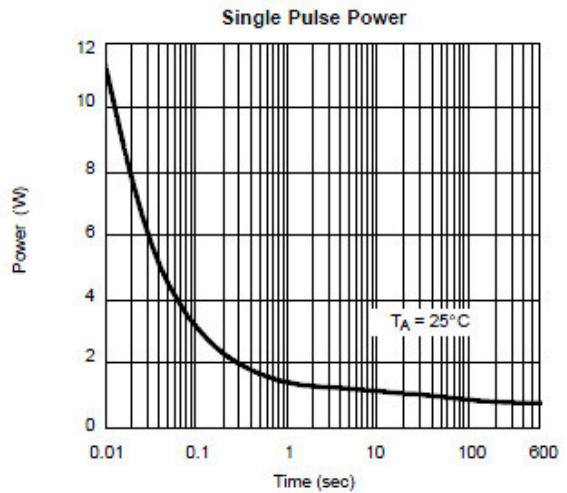
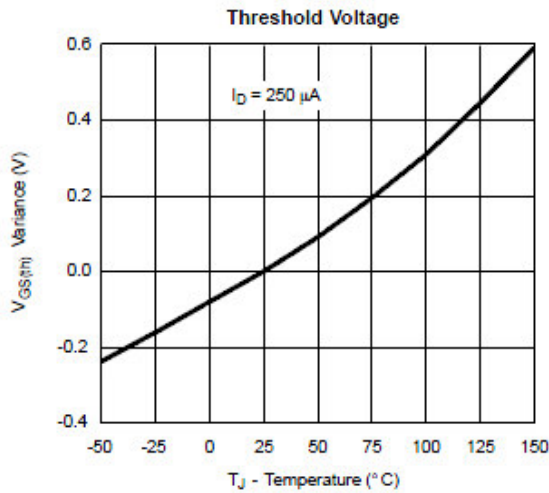
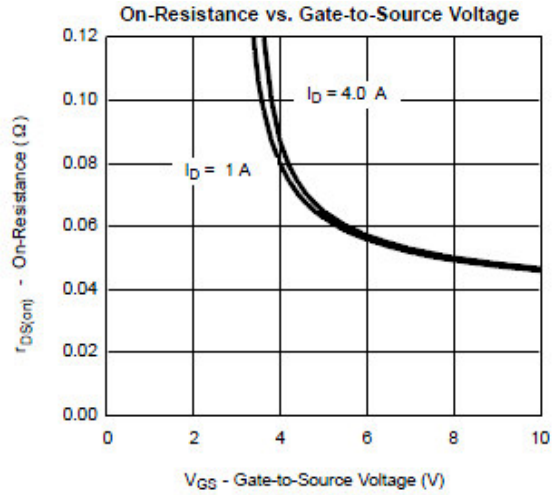
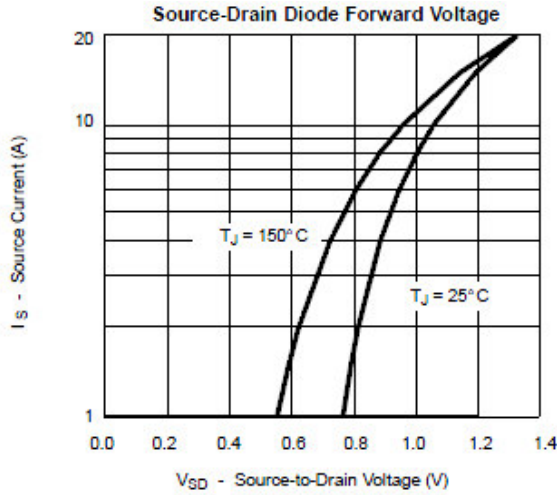



Typical Characteristics

Gate Charge Test Circuit & Waveform

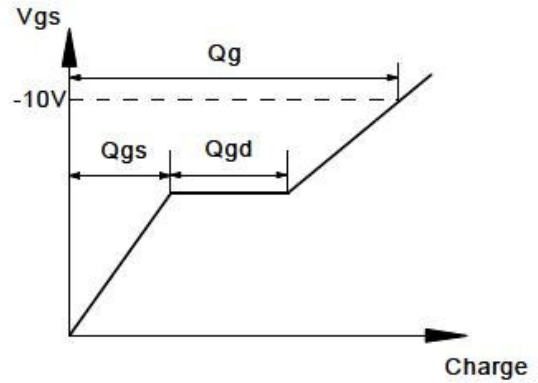
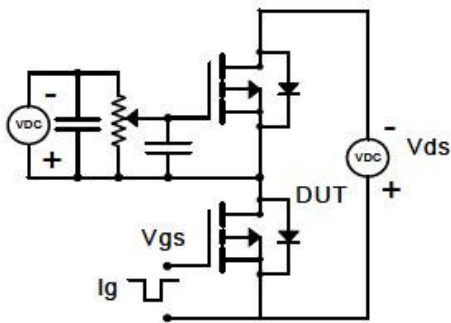

Resistive Switching Test Circuit & Waveforms

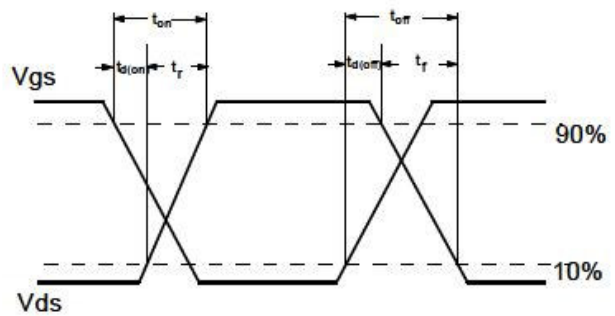
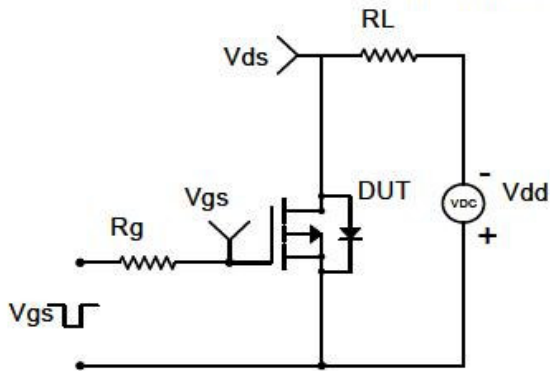

Diode Recovery Test Circuit & Waveforms

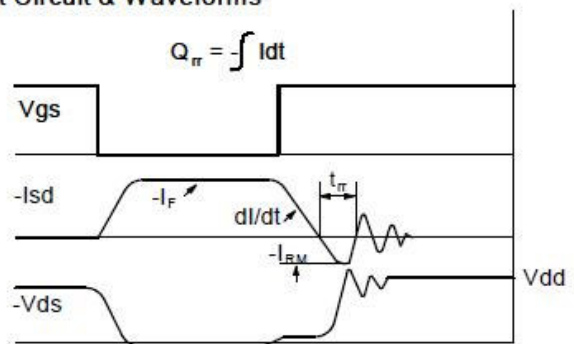
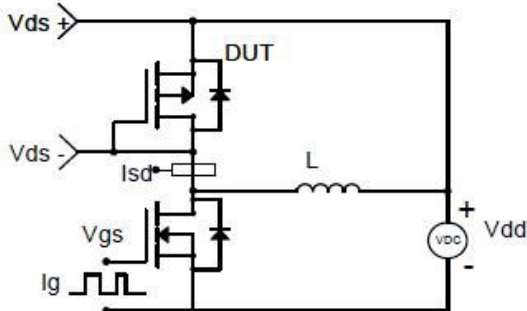



Package Information (SOT-23-3L)

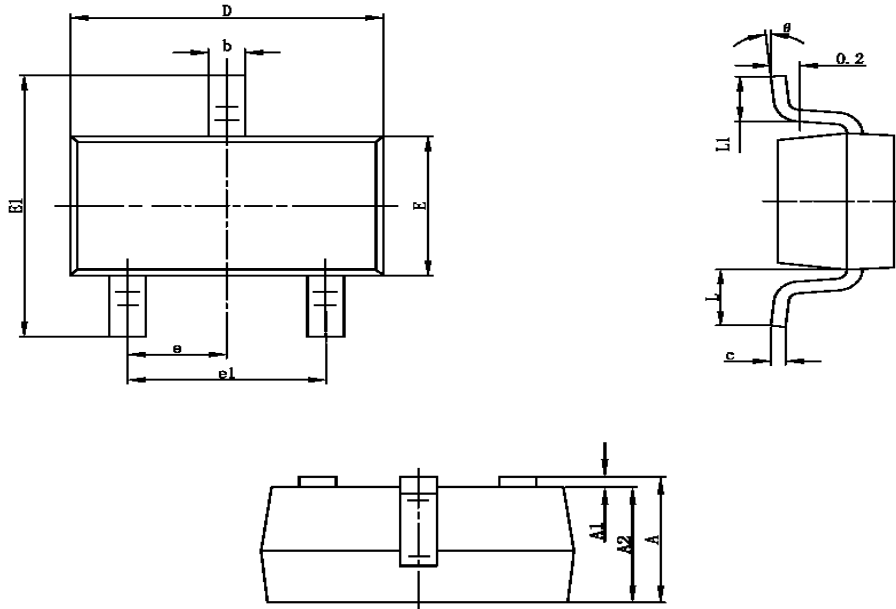

Symbol	Dimensions In Millimeters		Dimensions In Inches	
	Min	Max	Min	Max
A	1.050	1.250	0.041	0.049
A1	0.000	0.100	0.000	0.004
A2	1.050	1.150	0.041	0.045
b	0.300	0.400	0.012	0.016
c	0.100	0.200	0.004	0.008
D	2.820	3.020	0.111	0.119
E	1.500	1.700	0.059	0.067
E1	2.650	2.950	0.104	0.116
e	0.950TYP		0.037TYP	
e1	1.800	2.000	0.071	0.079
L	0.700REF		0.028REF	
L1	0.300	0.600	0.012	0.024
θ	0°	8°	0°	8°

©2010 Alfa-MOS Technology Corp.
 2F, No.80, Sec.1, Cheng Kung Rd., Nan Kang Dist., Taipei City 115, Taiwan (R.O.C.)
 Tel : 886 2) 2651 3928
 Fax : 886 2) 2786 8483
 ©http://www.alfa-mos.com