

FAIRCHILD

A Schlumberger Company

2N6763/2N6764 *T-39-13*
N-Channel Power MOSFETs,
38 A, 60 V/100 V

Power And Discrete Division

Description

These devices are n-channel, enhancement mode, power MOSFETs designed especially for high power, high speed applications, such as switching power supplies, UPS, AC and DC motor controls, relay and solenoid driver and high energy pulse circuits.

TO-204AE

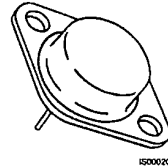

2N6763
2N6764

- V_{GS} Rated at ± 20 V
- Silicon Gate for Fast Switching Speeds
- I_{DSS} , $R_{DS(on)}$ Specified at Elevated Temperature
- Rugged
- Low Drive Requirements
- Ease of Paralleling

Maximum Ratings

Symbol	Characteristic	Rating 2N6764	Rating 2N6763	Unit
V_{DSS}	Drain to Source Voltage	100	60	V
V_{DGR}	Drain to Gate Voltage $R_{GS} = 1.0 \text{ M}\Omega$	100	60	V
V_{GS}	Gate to Source Voltage	± 20	± 20	V
T_J, T_{stg}	Operating Junction and Storage Temperatures	-55 to +150	-55 to +150	$^{\circ}\text{C}$
T_L	Maximum Lead Temperature for Soldering Purposes, 1/16" From Case for 10 s	300	300	$^{\circ}\text{C}$

Maximum On-State Characteristics

$R_{DS(on)}$	Static Drain-to-Source On Resistance	0.055	0.08	Ω
I_D	Drain Current Continuous at $T_C = 25^{\circ}\text{C}$ Continuous at $T_C = 100^{\circ}\text{C}$	38 24	31 20	A
I_{DM}	Pulsed	70 ²	60 ²	

Maximum Thermal Characteristics

$R_{\theta JC}$	Thermal Resistance, Junction to Case	0.83	0.83	$^{\circ}\text{C}/\text{W}$
P_D	Total Power Dissipation at $T_C = 25^{\circ}\text{C}$ at $T_C = 100^{\circ}\text{C}$	150 60	150 60	W
	Linear Derating Factor	1.2	1.2	W/ $^{\circ}\text{C}$

Notes

All values are JEDEC registered except as noted. For information concerning connection diagram and package outline, refer to Section 7.

Electrical Characteristics ($T_C = 25^\circ\text{C}$ unless otherwise noted)

Symbol	Characteristic	Min	Max	Unit	Test Conditions
Off Characteristics					
$V_{(BR)DSS}$	Drain Source Breakdown Voltage			V	$V_{GS} = 0\text{ V}, I_D = 1\text{ m}$
	2N6764	100 ²			
	2N6763	60 ²			
I_{DSS}	Zero Gate Voltage Drain Current		1	mA	$V_{DS} = \text{Rated } V_{DSS}, V_{GS} = 0\text{ V}$ $V_{DS} = \text{Rated } V_{DSS}, V_{GS} = 0\text{ V}, T_C = 125^\circ\text{C}$
			4		
I_{GSS}	Gate-Body Leakage Current		± 100	nA	$V_{GS} = \pm 20\text{ V}, V_{DS} = 0\text{ V}$
On Characteristics					
$V_{GS(th)}$	Gate Threshold Voltage	2.0	4.0	V	$I_D = 1\text{ mA}, V_{DS} = V_{GS}$
$R_{DS(on)}$	Static Drain-Source On-Resistance ¹			Ω	$V_{GS} = 10\text{ V}$ $I_D = 24\text{ A}$ $I_D = 20\text{ A}$ $I_D = 24\text{ A}; T_C = 125^\circ\text{C}$ $I_D = 20\text{ A}; T_C = 125^\circ\text{C}$
		2N6764	0.055		
		2N6763	0.080		
		2N6764	0.094		
		2N6763	0.136		
$V_{DS(on)}$	Drain-Source On-Voltage ¹		2.09	V	$V_{GS} = 10\text{ V}$ $I_D = 38\text{ A}$ $I_D = 31\text{ A}$
			2.48		
g_{fs}	Forward Transconductance ¹	9.0	27	S (Ω)	$V_{DS} = 15\text{ V}, I_D = 24\text{ A}$
Dynamic Characteristics					
C_{iss}	Input Capacitance	1000	3000	pF	$V_{DS} = 25\text{ V}, V_{GS} = 0\text{ V}$ $f = 1.0\text{ MHz}$
C_{dss}	Output Capacitance	500	1500	pF	
C_{rss}	Reverse Transfer Capacitance	150	500	pF	
Switching Characteristics ($T_C = 25^\circ\text{C}$, Figures 9, 10)					
$t_{d(on)}$	Turn-On Delay Time		35	ns	$V_{DD} = 24\text{ V}, I_D = 24\text{ A}$ $V_{GS} = 10\text{ V}, R_{GEN} = 4.7\ \Omega$ $R_{GS} = 4.7\ \Omega$
t_r	Rise Time		100	ns	
$t_{d(off)}$	Turn-Off Delay Time		125	ns	
t_f	Fall Time		100	ns	
Q_g	Total Gate Charge		120 ²	nC	$V_{GS} = 10\text{ V}, I_D = 50\text{ A}$ $V_{DD} = 55\text{ V}$

Electrical Characteristics (Cont.) ($T_C = 25^\circ\text{C}$ unless otherwise noted)

Symbol	Characteristic	Min	Typ	Max	Unit	Test Conditions
Source-Drain Diode Characteristics						
I_S	Continuous Source Current 2N6764 2N6763			38 31	A	
I_{SM}	Pulsed Source Current 2N6764 2N6763			70 60	A	
V_{SD}	Diode Forward Voltage 2N6764 2N6763	0.95		1.9	V	$V_{GS} = 0\text{ V}$ $I_S = 38\text{ A}$
		0.90		1.8		$I_S = 31\text{ A}$
t_{rr}	Reverse Recovery Time		500^2		ns	$V_{GS} = 0\text{ V}$, $T_J = 150^\circ\text{C}$ $I_F = I_{SM}$, $dI_F/dt = 100\text{ A}/\mu\text{S}$
Q_{RR}	Reverse Recovery Charge		10^2		μC	$V_{GS} = 0\text{ V}$, $T_J = 150^\circ\text{C}$ $I_F = I_{SM}$, $dI_F/dt = 100\text{ A}/\mu\text{S}$

Notes

1. Pulse test: Pulse width $\leq 20\ \mu\text{s}$, Duty cycle $\leq 2\%$
2. Non-JEDEC registered value.

Typical Performance Curves

Figure 1 Output Characteristics

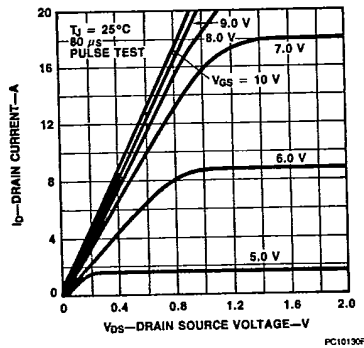
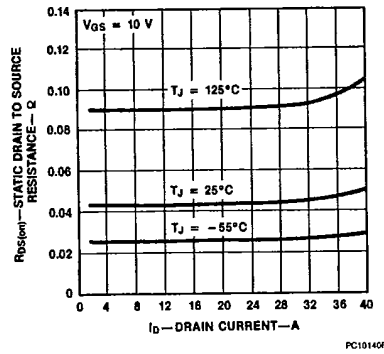

Figure 2 Static Drain to Source Resistance vs Drain Current



Typical Performance Curves (Cont.)

Figure 3 Transfer Characteristics

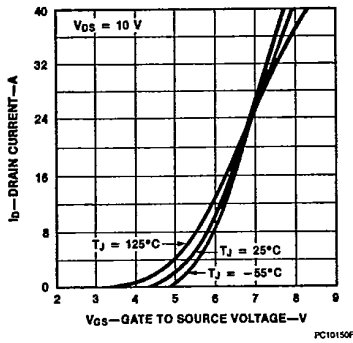

Figure 4 Temperature Variation of Gate to Source Threshold Voltage

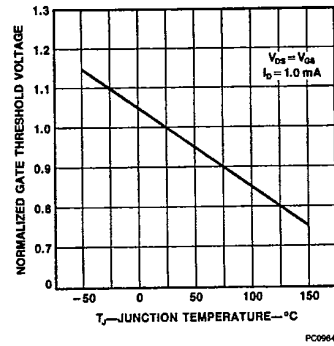

Figure 5 Capacitance vs Drain to Source Voltage

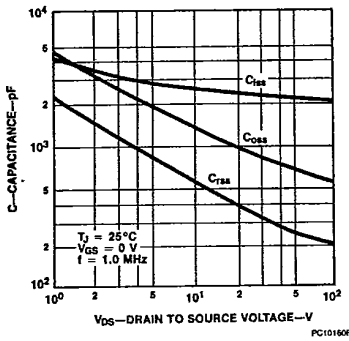

Figure 6 Gate to Source Voltage vs Total Gate Charge

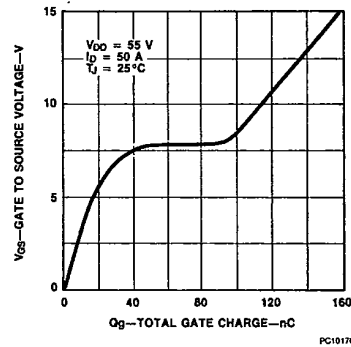

Figure 7 Forward Biased Safe Operating Area

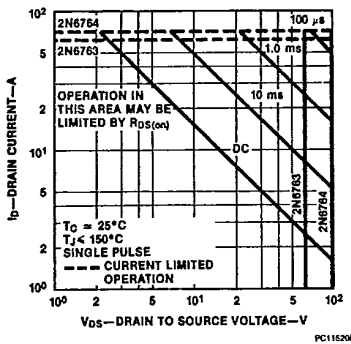
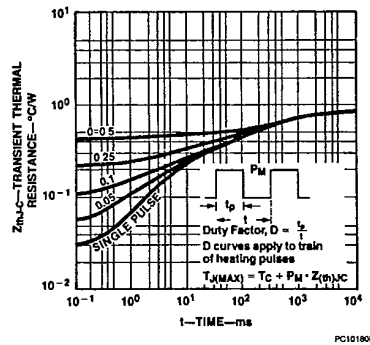

Figure 8 Transient Thermal Resistance vs Time



Typical Electrical Characteristics

Figure 9 Switching Test Circuit

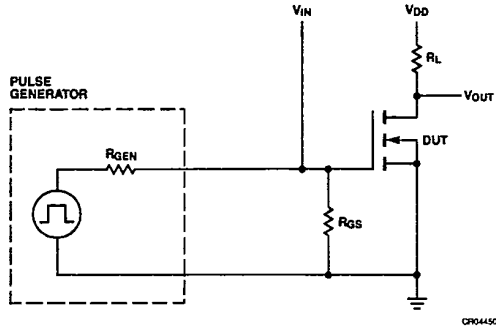
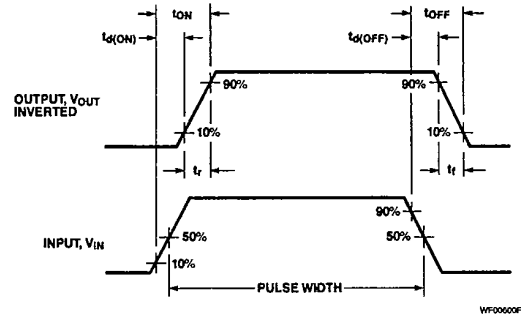

Figure 10 Switching Waveforms



2