

Automotive P-Channel 60 V (D-S) 175 °C MOSFET



RoHS
COMPLIANT
HALOGEN
FREE

PRODUCT SUMMARY	
V_{DS} (V)	- 60
$R_{DS(on)}$ (Ω) at $V_{GS} = -10$ V	0.0067
$R_{DS(on)}$ (Ω) at $V_{GS} = -4.5$ V	0.0088
I_D (A)	- 120
Configuration	Single

FEATURES

- TrenchFET® Power MOSFET
- Package with Low Thermal Resistance
- 100 % R_g and UIS Tested
- AEC-Q101 Qualified^d
- Material categorization:
For definitions of compliance please see www.vishay.com/doc?99912

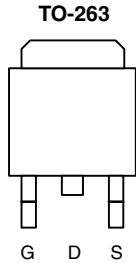

Top View

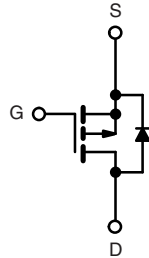

P-Channel MOSFET

ORDERING INFORMATION	
Package	TO-263
Lead (Pb)-free and Halogen-free	SQM120P06-07L-GE3

ABSOLUTE MAXIMUM RATINGS ($T_C = 25$ °C, unless otherwise noted)				
PARAMETER	SYMBOL	LIMIT	UNIT	
Drain-Source Voltage	V_{DS}	- 60	V	
Gate-Source Voltage	V_{GS}	± 20		
Continuous Drain Current ^a	I_D	$T_C = 25$ °C ^a	- 120	
		$T_C = 125$ °C	- 98	
Continuous Source Current (Diode Conduction) ^a	I_S	- 120	A	
Pulsed Drain Current ^b	I_{DM}	- 480		
Single Pulse Avalanche Current	I_{AS}	- 80		
Single Pulse Avalanche Energy	E_{AS}	L = 0.1 mH	320	mJ
Maximum Power Dissipation ^b			P_D	
		$T_C = 125$ °C		125
Operating Junction and Storage Temperature Range	T_J, T_{stg}	- 55 to + 175	°C	

THERMAL RESISTANCE RATINGS			
PARAMETER	SYMBOL	LIMIT	UNIT
Junction-to-Ambient	R_{thJA}	40	°C/W
Junction-to-Case (Drain)			

Notes

- Package limited.
- Pulse test; pulse width ≤ 300 μ s, duty cycle ≤ 2 %.
- When mounted on 1" square PCB (FR-4 material).
- Parametric verification ongoing.



SPECIFICATIONS (T _C = 25 °C, unless otherwise noted)						
PARAMETER	SYMBOL	TEST CONDITIONS	MIN.	TYP.	MAX.	UNIT
Static						
Drain-Source Breakdown Voltage	V _{DS}	V _{GS} = 0 V, I _D = - 250 μA	- 60	-	-	V
Gate-Source Threshold Voltage	V _{GS(th)}	V _{DS} = V _{GS} , I _D = - 250 μA	- 1.5	- 2.0	- 2.5	
Gate-Source Leakage	I _{GSS}	V _{DS} = 0 V, V _{GS} = ± 20 V	-	-	± 100	nA
Zero Gate Voltage Drain Current	I _{DSS}	V _{GS} = 0 V, V _{DS} = - 60 V	-	-	- 1	μA
		V _{GS} = 0 V, V _{DS} = - 60 V, T _J = 125 °C	-	-	- 50	
		V _{GS} = 0 V, V _{DS} = - 60 V, T _J = 175 °C	-	-	- 250	
On-State Drain Current ^a	I _{D(on)}	V _{GS} = - 10 V, V _{DS} ≤ - 5 V	- 120	-	-	A
Drain-Source On-State Resistance ^a	R _{DS(on)}	V _{GS} = - 10 V, I _D = - 30 A	-	0.0056	0.0067	Ω
		V _{GS} = - 10 V, I _D = - 30 A, T _J = 125 °C	-	-	0.0110	
		V _{GS} = - 10 V, I _D = - 30 A, T _J = 175 °C	-	-	0.0130	
		V _{GS} = - 4.5 V, I _D = - 20 A	-	0.0070	0.0088	
Forward Transconductance ^b	g _{fs}	V _{DS} = - 15 V, I _D = - 30 A	-	90	-	S
Dynamic^b						
Input Capacitance	C _{iss}	V _{GS} = 0 V, V _{DS} = - 25 V, f = 1 MHz	-	11 423	14 280	pF
Output Capacitance	C _{oss}		-	1034	1295	
Reverse Transfer Capacitance	C _{rss}		-	809	1015	
Total Gate Charge ^c	Q _g	V _{GS} = - 10 V, V _{DS} = - 30 V, I _D = - 110 A	-	180	270	nC
Gate-Source Charge ^c	Q _{gs}		-	31	-	
Gate-Drain Charge ^c	Q _{gd}		-	43	-	
Gate Resistance	R _g	f = 1 MHz	1.1	2.27	3.5	Ω
Turn-On Delay Time ^c	t _{d(on)}	V _{DD} = - 30 V, R _L = 0.27 Ω, I _D ≅ - 110 A, V _{GEN} = - 10 V, R _g = 1 Ω	-	15	23	ns
Rise Time ^c	t _r		-	23	35	
Turn-Off Delay Time ^c	t _{d(off)}		-	97	146	
Fall Time ^c	t _f		-	32	48	
Source-Drain Diode Ratings and Characteristics^b						
Pulsed Current ^a	I _{SM}		-	-	- 480	A
Forward Voltage	V _{SD}	I _F = - 100 A, V _{GS} = 0 V	-	- 0.95	- 1.5	V

Notes

- a. Pulse test; pulse width ≤ 300 μs, duty cycle ≤ 2 %.
- b. Guaranteed by design, not subject to production testing.
- c. Independent of operating temperature.

Stresses beyond those listed under "Absolute Maximum Ratings" may cause permanent damage to the device. These are stress ratings only, and functional operation of the device at these or any other conditions beyond those indicated in the operational sections of the specifications is not implied. Exposure to absolute maximum rating conditions for extended periods may affect device reliability.



TYPICAL CHARACTERISTICS (T_A = 25 °C, unless otherwise noted)

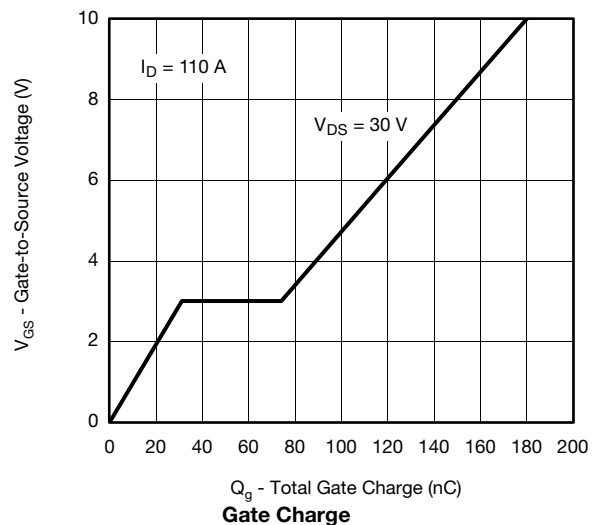
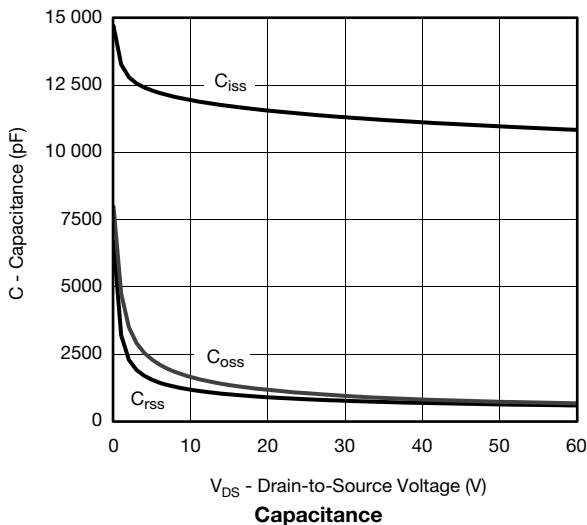
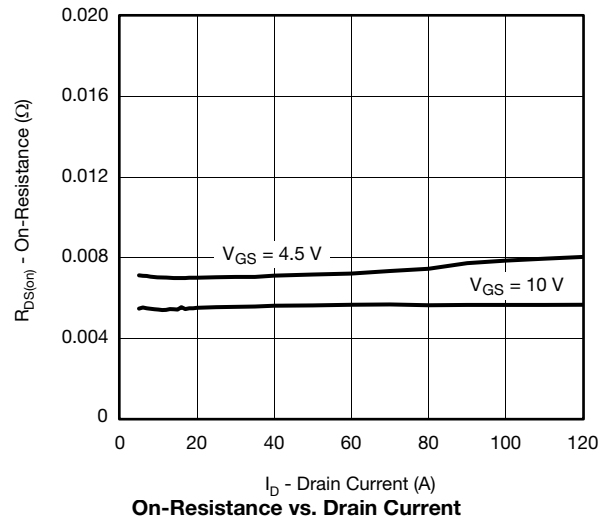
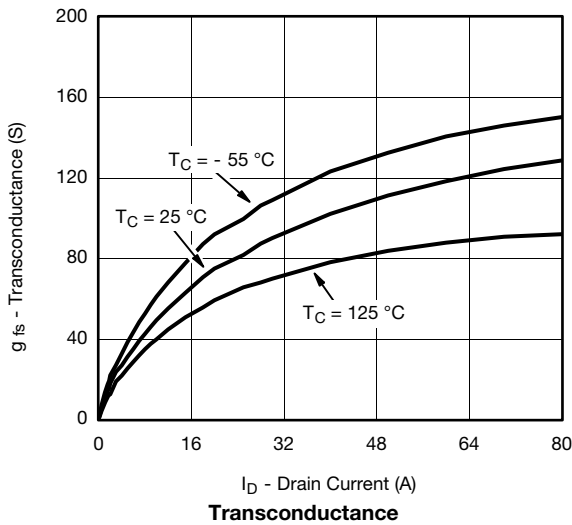
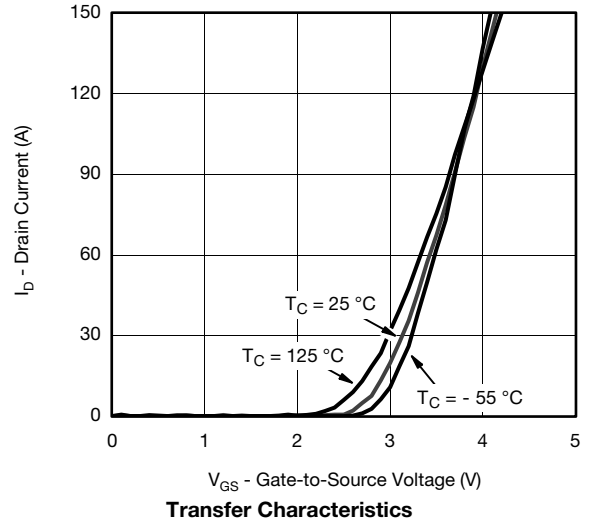
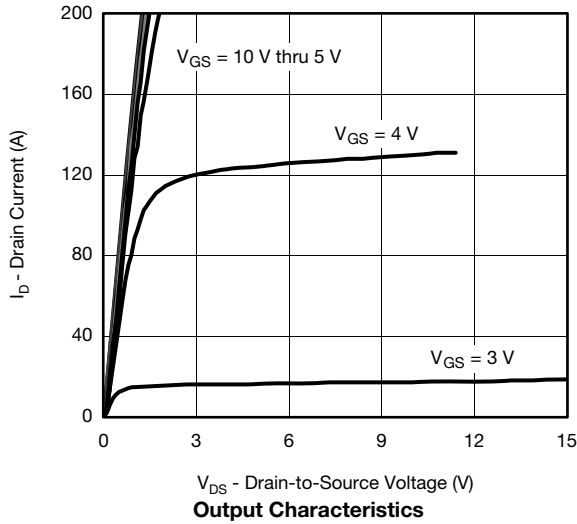



TYPICAL CHARACTERISTICS (T_A = 25 °C, unless otherwise noted)

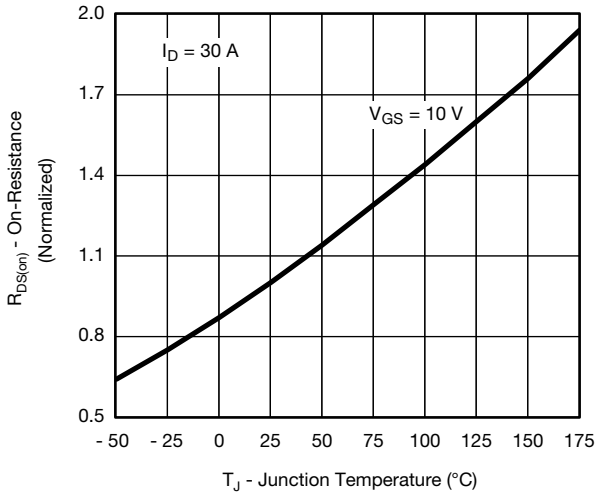

On-Resistance vs. Junction Temperature

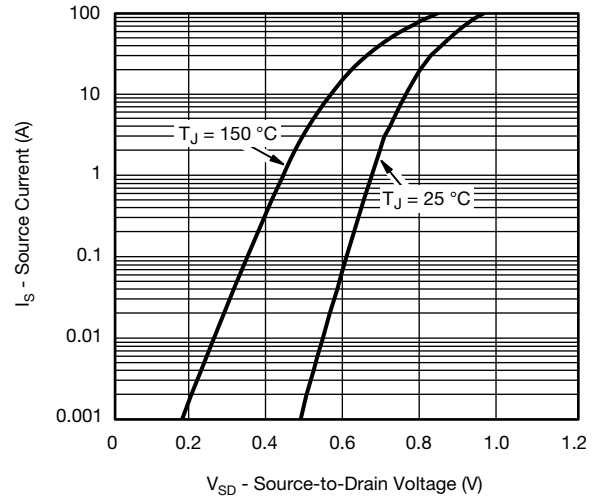

Source Drain Diode Forward Voltage

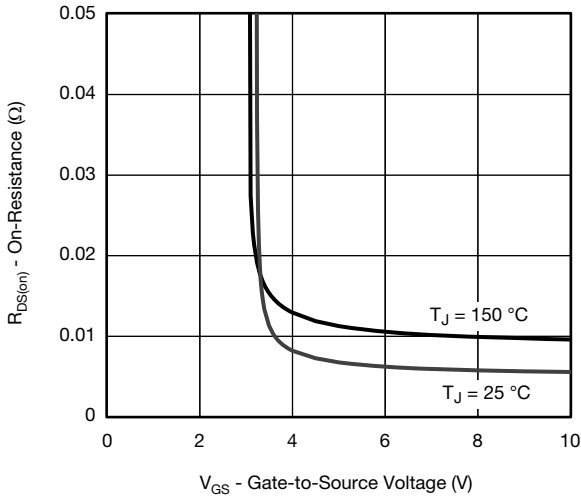

On-Resistance vs. Gate-to-Source Voltage

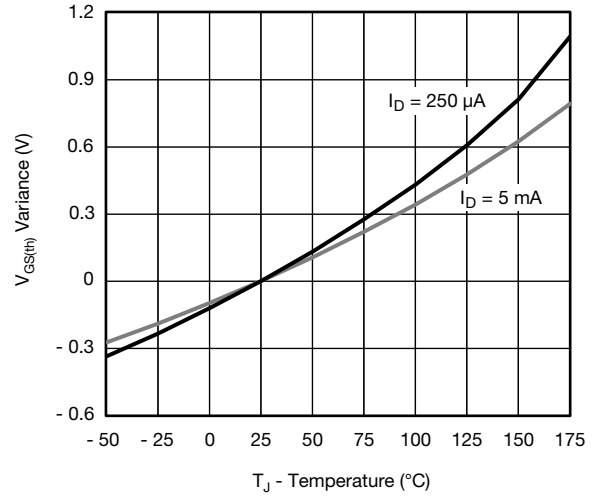

Threshold Voltage

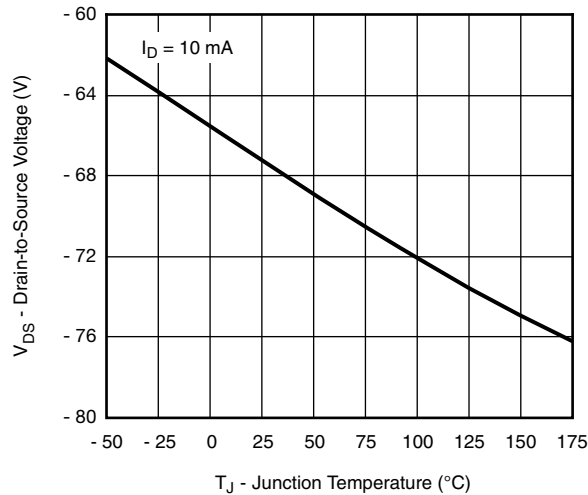

Drain Source Breakdown vs. Junction Temperature



THERMAL RATINGS ($T_A = 25\text{ }^\circ\text{C}$, unless otherwise noted)

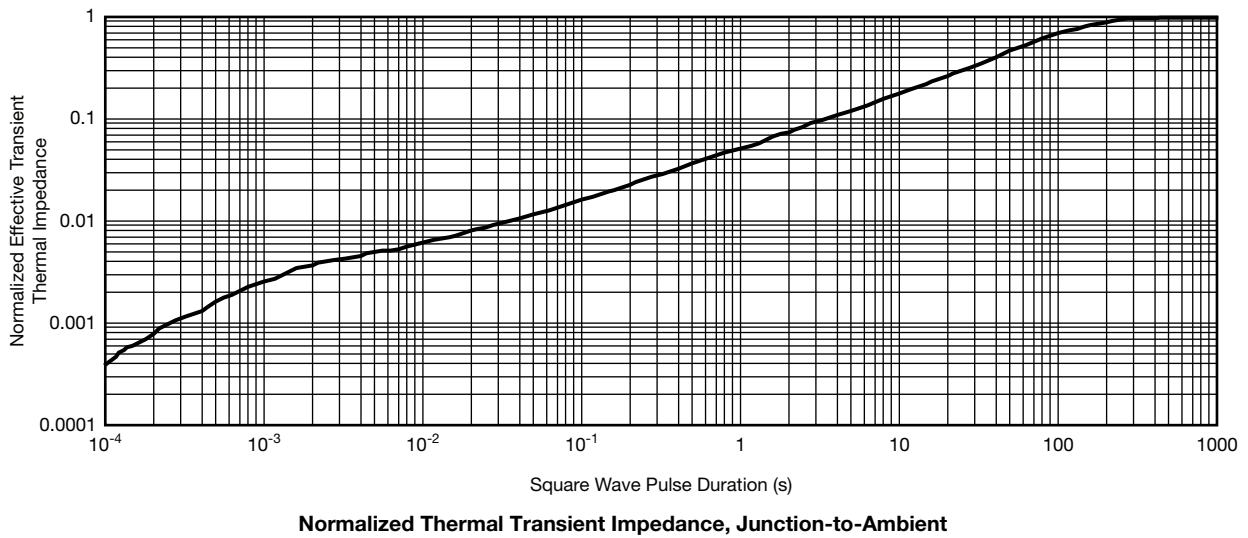
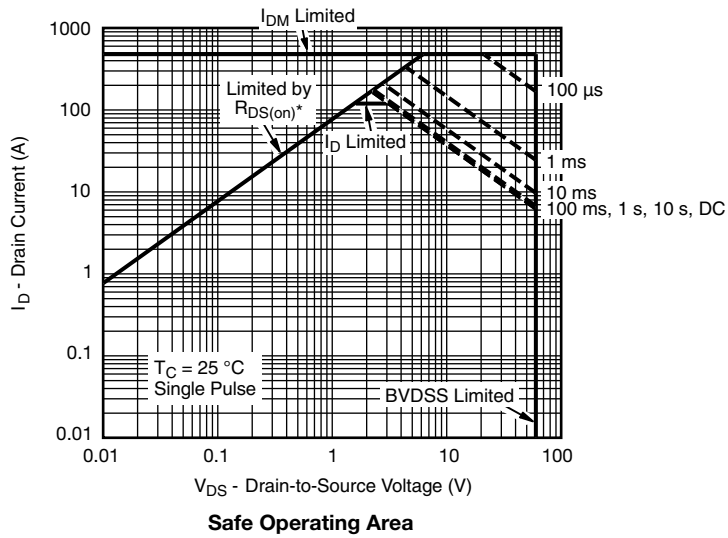



THERMAL RATINGS ($T_A = 25\text{ }^\circ\text{C}$, unless otherwise noted)

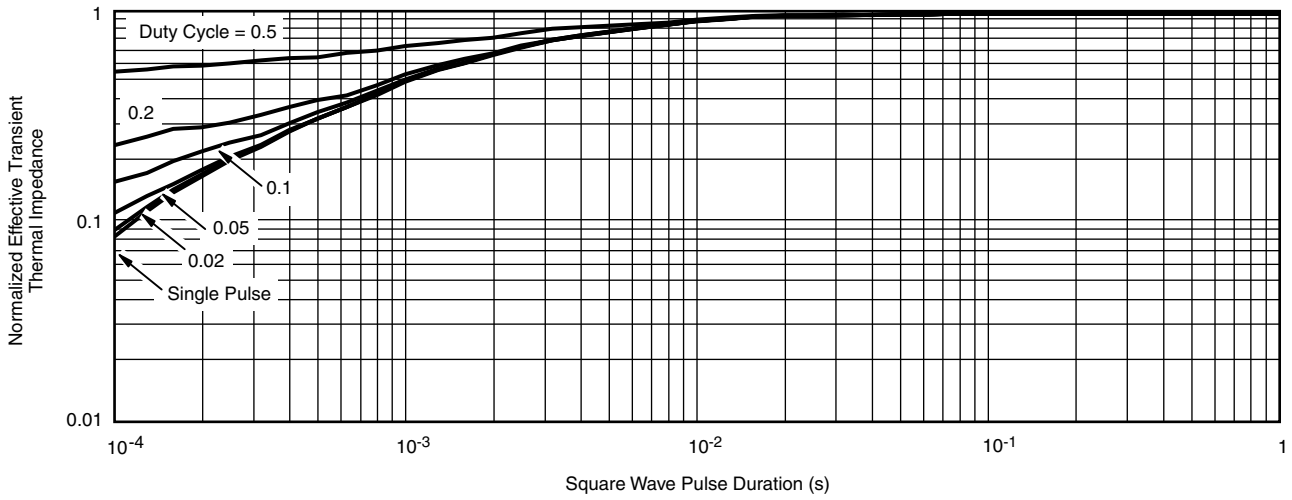

Normalized Thermal Transient Impedance, Junction-to-Case

Note

- The characteristics shown in the two graphs
 - Normalized Transient Thermal Impedance Junction to Ambient (25 °C)
 - Normalized Transient Thermal Impedance Junction to Case (25 °C)
 are given for general guidelines only to enable the user to get a “ball park” indication of part capabilities. The data are extracted from single pulse transient thermal impedance characteristics which are developed from empirical measurements. The latter is valid for the part mounted on printed circuit board - FR4, size 1" x 1" x 0.062", double sided with 2 oz. copper, 100 % on both sides. The part capabilities can widely vary depending on actual application parameters and operating conditions.

Vishay Siliconix maintains worldwide manufacturing capability. Products may be manufactured at one of several qualified locations. Reliability data for Silicon Technology and Package Reliability represent a composite of all qualified locations. For related documents such as package/tape drawings, part marking, and reliability data, see www.vishay.com/ppg?67026.

TO-263 (D²PAK): 3-LEAD

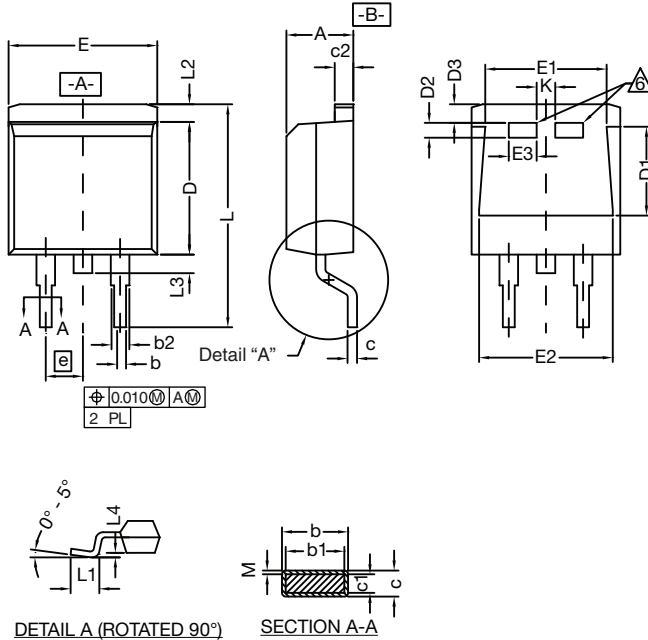

DIM.	INCHES		MILLIMETERS		
	MIN.	MAX.	MIN.	MAX.	
A	0.160	0.190	4.064	4.826	
b	0.020	0.039	0.508	0.990	
b1	0.020	0.035	0.508	0.889	
b2	0.045	0.055	1.143	1.397	
c*	Thin lead	0.013	0.018	0.330	0.457
	Thick lead	0.023	0.028	0.584	0.711
c1	Thin lead	0.013	0.017	0.330	0.431
	Thick lead	0.023	0.027	0.584	0.685
c2	0.045	0.055	1.143	1.397	
D	0.340	0.380	8.636	9.652	
D1	0.220	0.240	5.588	6.096	
D2	0.038	0.042	0.965	1.067	
D3	0.045	0.055	1.143	1.397	
E	0.380	0.410	9.652	10.414	
E1	0.245	-	6.223	-	
E2	0.355	0.375	9.017	9.525	
E3	0.072	0.078	1.829	1.981	
[e]	0.100 BSC		2.54 BSC		
K	0.045	0.055	1.143	1.397	
L	0.575	0.625	14.605	15.875	
L1	0.090	0.110	2.286	2.794	
L2	0.040	0.055	1.016	1.397	
L3	0.050	0.070	1.270	1.778	
L4	0.010 BSC		0.254 BSC		
M	-	0.002	-	0.050	

ECN: T10-0738-Rev. J, 03-Jan-11
DWG: 5843

Notes

- Plane B includes maximum features of heat sink tab and plastic.
- No more than 25 % of L1 can fall above seating plane by max. 8 mils.
- Pin-to-pin coplanarity max. 4 mils.
- *: Thin lead is for SUB, SYB.
Thick lead is for SUM, SYM, SQM.
- Use inches as the primary measurement.
- This feature is for thick lead.

RECOMMENDED MINIMUM PADS FOR D²PAK: 3-Lead



Recommended Minimum Pads
Dimensions in Inches/(mm)

[Return to Index](#)



Disclaimer

ALL PRODUCT, PRODUCT SPECIFICATIONS AND DATA ARE SUBJECT TO CHANGE WITHOUT NOTICE TO IMPROVE RELIABILITY, FUNCTION OR DESIGN OR OTHERWISE.

Vishay Intertechnology, Inc., its affiliates, agents, and employees, and all persons acting on its or their behalf (collectively, "Vishay"), disclaim any and all liability for any errors, inaccuracies or incompleteness contained in any datasheet or in any other disclosure relating to any product.

Vishay makes no warranty, representation or guarantee regarding the suitability of the products for any particular purpose or the continuing production of any product. To the maximum extent permitted by applicable law, Vishay disclaims (i) any and all liability arising out of the application or use of any product, (ii) any and all liability, including without limitation special, consequential or incidental damages, and (iii) any and all implied warranties, including warranties of fitness for particular purpose, non-infringement and merchantability.

Statements regarding the suitability of products for certain types of applications are based on Vishay's knowledge of typical requirements that are often placed on Vishay products in generic applications. Such statements are not binding statements about the suitability of products for a particular application. It is the customer's responsibility to validate that a particular product with the properties described in the product specification is suitable for use in a particular application. Parameters provided in datasheets and/or specifications may vary in different applications and performance may vary over time. All operating parameters, including typical parameters, must be validated for each customer application by the customer's technical experts. Product specifications do not expand or otherwise modify Vishay's terms and conditions of purchase, including but not limited to the warranty expressed therein.

Except as expressly indicated in writing, Vishay products are not designed for use in medical, life-saving, or life-sustaining applications or for any other application in which the failure of the Vishay product could result in personal injury or death. Customers using or selling Vishay products not expressly indicated for use in such applications do so at their own risk. Please contact authorized Vishay personnel to obtain written terms and conditions regarding products designed for such applications.

No license, express or implied, by estoppel or otherwise, to any intellectual property rights is granted by this document or by any conduct of Vishay. Product names and markings noted herein may be trademarks of their respective owners.

Material Category Policy

Vishay Intertechnology, Inc. hereby certifies that all its products that are identified as RoHS-Compliant fulfill the definitions and restrictions defined under Directive 2011/65/EU of The European Parliament and of the Council of June 8, 2011 on the restriction of the use of certain hazardous substances in electrical and electronic equipment (EEE) - recast, unless otherwise specified as non-compliant.

Please note that some Vishay documentation may still make reference to RoHS Directive 2002/95/EC. We confirm that all the products identified as being compliant to Directive 2002/95/EC conform to Directive 2011/65/EU.

Vishay Intertechnology, Inc. hereby certifies that all its products that are identified as Halogen-Free follow Halogen-Free requirements as per JEDEC JS709A standards. Please note that some Vishay documentation may still make reference to the IEC 61249-2-21 definition. We confirm that all the products identified as being compliant to IEC 61249-2-21 conform to JEDEC JS709A standards.