

Automotive N-Channel 40 V (D-S) 175 °C MOSFET

 AUTOMOTIVE
GRADE

RoHS
COMPLIANT
HALOGEN
FREE

PRODUCT SUMMARY	
V_{DS} (V)	40
$R_{DS(on)}$ (Ω) at $V_{GS} = 10$ V	0.006
$R_{DS(on)}$ (Ω) at $V_{GS} = 4.5$ V	0.008
I_D (A)	32
Configuration	Single

FEATURES

- TrenchFET® Power MOSFET
- AEC-Q101 Qualified^d
- 100 % R_g and UIS Tested
- Material categorization:
For definitions of compliance please see www.vishay.com/doc?99912

PowerPAK® SO-8L Single

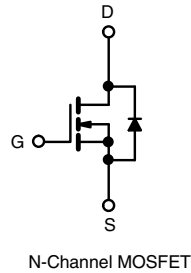
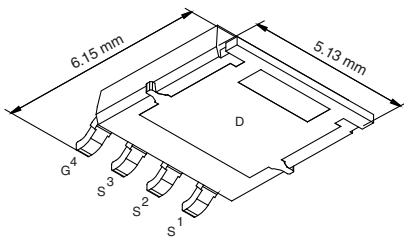

ORDERING INFORMATION	
Package	PowerPAK SO-8L
Lead (Pb)-free and Halogen-free	SQJ884EP-T1-GE3

ABSOLUTE MAXIMUM RATINGS ($T_C = 25$ °C, unless otherwise noted)			
PARAMETER	SYMBOL	LIMIT	UNIT
Drain-Source Voltage	V_{DS}	40	V
Gate-Source Voltage	V_{GS}	± 20	
Continuous Drain Current ^a	I_D	$T_C = 25$ °C	32
		$T_C = 125$ °C	32
Continuous Source Current (Diode Conduction) ^a	I_S	32	A
Pulsed Drain Current ^b	I_{DM}	128	
Single Pulse Avalanche Current	I_{AS}	40	
Single Pulse Avalanche Energy			
Maximum Power Dissipation ^b	P_D	$T_C = 25$ °C	55
		$T_C = 125$ °C	18
Operating Junction and Storage Temperature Range	T_J, T_{stg}	- 55 to + 175	°C
Soldering Recommendations (Peak Temperature) ^{e, f}		260	

THERMAL RESISTANCE RATINGS			
PARAMETER	SYMBOL	LIMIT	UNIT
Junction-to-Ambient	R_{thJA}	70	°C/W
Junction-to-Case (Drain)			

Notes

- Package limited.
- Pulse test; pulse width ≤ 300 μ s, duty cycle ≤ 2 %.
- When mounted on 1" square PCB (FR-4 material).
- Parametric verification ongoing.
- See Solder Profile (www.vishay.com/doc?73257). The PowerPAK SO-8L. The end of the lead terminal is exposed copper (not plated) as a result of the singulation process in manufacturing. A solder fillet at the exposed copper tip cannot be guaranteed and is not required to ensure adequate bottom side solder interconnection.
- Rework conditions: manual soldering with a soldering iron is not recommended for leadless components.



SPECIFICATIONS ($T_C = 25\text{ }^\circ\text{C}$, unless otherwise noted)							
PARAMETER	SYMBOL	TEST CONDITIONS		MIN.	TYP.	MAX.	UNIT
Static							
Drain-Source Breakdown Voltage	V_{DS}	$V_{GS} = 0\text{ V}, I_D = 250\text{ }\mu\text{A}$		40	-	-	V
Gate-Source Threshold Voltage	$V_{GS(th)}$	$V_{DS} = V_{GS}, I_D = 250\text{ }\mu\text{A}$		1.5	2.0	2.5	
Gate-Source Leakage	I_{GSS}	$V_{DS} = 0\text{ V}, V_{GS} = \pm 20\text{ V}$		-	-	± 100	nA
Zero Gate Voltage Drain Current	I_{DSS}	$V_{GS} = 0\text{ V}$	$V_{DS} = 40\text{ V}$	-	-	1	μA
		$V_{GS} = 0\text{ V}$	$V_{DS} = 40\text{ V}, T_J = 125\text{ }^\circ\text{C}$	-	-	50	
		$V_{GS} = 0\text{ V}$	$V_{DS} = 40\text{ V}, T_J = 175\text{ }^\circ\text{C}$	-	-	150	
On-State Drain Current ^a	$I_{D(on)}$	$V_{GS} = 10\text{ V}$	$V_{DS} \geq 5\text{ V}$	30	-	-	A
Drain-Source On-State Resistance ^a	$R_{DS(on)}$	$V_{GS} = 10\text{ V}$	$I_D = 13\text{ A}$	-	0.0053	0.006	Ω
		$V_{GS} = 4.5\text{ V}$	$I_D = 10\text{ A}$	-	0.0060	0.008	
		$V_{GS} = 10\text{ V}$	$I_D = 13\text{ A}, T_J = 125\text{ }^\circ\text{C}$	-	-	0.0088	
		$V_{GS} = 10\text{ V}$	$I_D = 13\text{ A}, T_J = 175\text{ }^\circ\text{C}$	-	-	0.0107	
Forward Transconductance ^b	g_{fs}	$V_{DS} = 15\text{ V}, I_D = 13\text{ A}$		-	90	-	S
Dynamic^b							
Input Capacitance	C_{iss}	$V_{GS} = 0\text{ V}$	$V_{DS} = 20\text{ V}, f = 1\text{ MHz}$	-	2368	2960	μF
Output Capacitance	C_{oss}			-	360	450	
Reverse Transfer Capacitance	C_{rss}			-	140	175	
Total Gate Charge ^c	Q_g	$V_{GS} = 10\text{ V}$	$V_{DS} = 20\text{ V}, I_D = 20\text{ A}$	-	43	65	nC
Gate-Source Charge ^c	Q_{gs}			-	7.5	-	
Gate-Drain Charge ^c	Q_{gd}			-	7.1	-	
Gate Resistance	R_g	f = 1 MHz		1.5	2.98	5	Ω
Turn-On Delay Time ^c	$t_{d(on)}$	$V_{DD} = 20\text{ V}, R_L = 2\text{ }\Omega$ $I_D \cong 10\text{ A}, V_{GEN} = 10\text{ V}, R_g = 1\text{ }\Omega$		-	10	15	ns
Rise Time ^c	t_r			-	11	17	
Turn-Off Delay Time ^c	$t_{d(off)}$			-	31	47	
Fall Time ^c	t_f			-	8	12	
Source-Drain Diode Ratings and Characteristics^b							
Pulsed Current ^a	I_{SM}			-	-	128	A
Forward Voltage	V_{SD}	$I_F = 10\text{ A}, V_{GS} = 0\text{ V}$		-	0.8	1.2	V

Notes

- a. Pulse test; pulse width $\leq 300\text{ }\mu\text{s}$, duty cycle $\leq 2\%$.
- b. Guaranteed by design, not subject to production testing.
- c. Independent of operating temperature.

Stresses beyond those listed under "Absolute Maximum Ratings" may cause permanent damage to the device. These are stress ratings only, and functional operation of the device at these or any other conditions beyond those indicated in the operational sections of the specifications is not implied. Exposure to absolute maximum rating conditions for extended periods may affect device reliability.

TYPICAL CHARACTERISTICS ($T_A = 25\text{ }^\circ\text{C}$, unless otherwise noted)

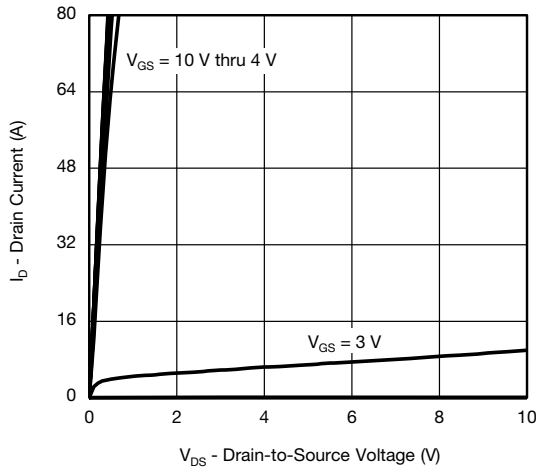

Output Characteristics

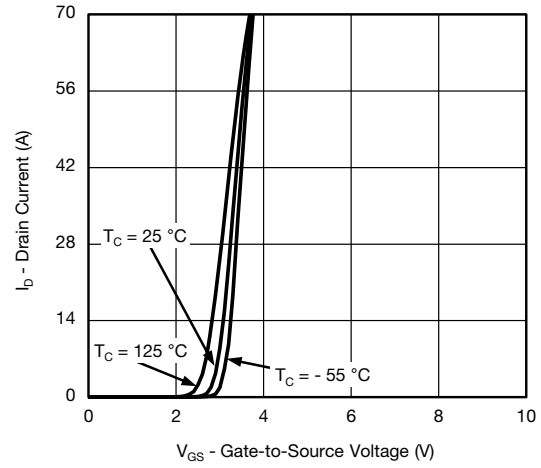

Transfer Characteristics

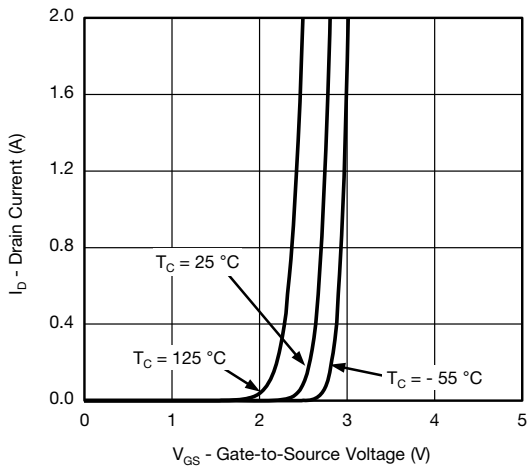

Transfer Characteristics

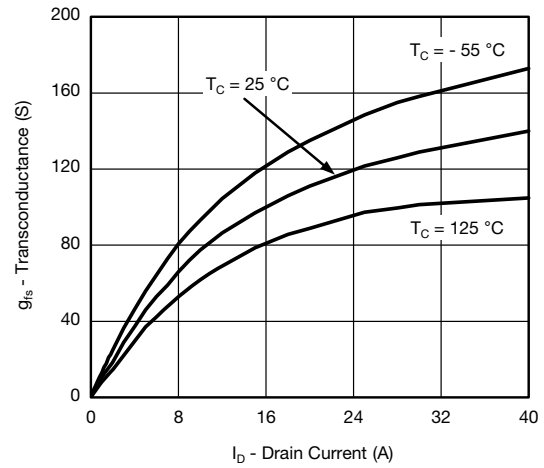

Transconductance

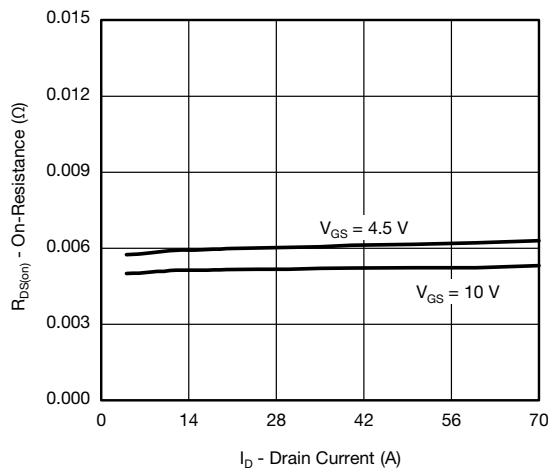

On-Resistance vs. Drain Current

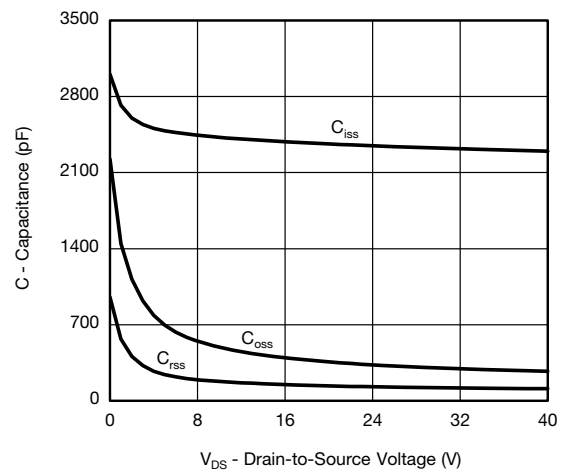

Capacitance



TYPICAL CHARACTERISTICS ($T_A = 25\text{ }^\circ\text{C}$, unless otherwise noted)

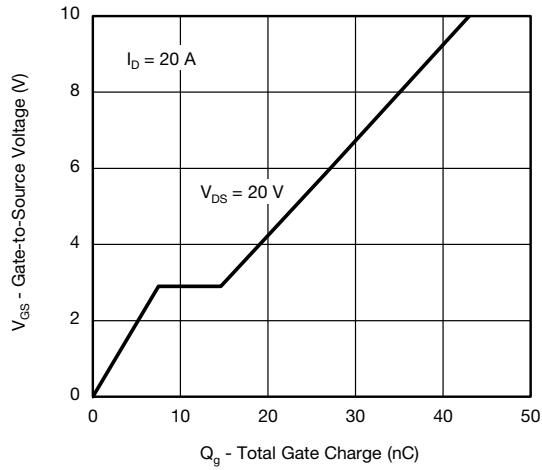

Gate Charge

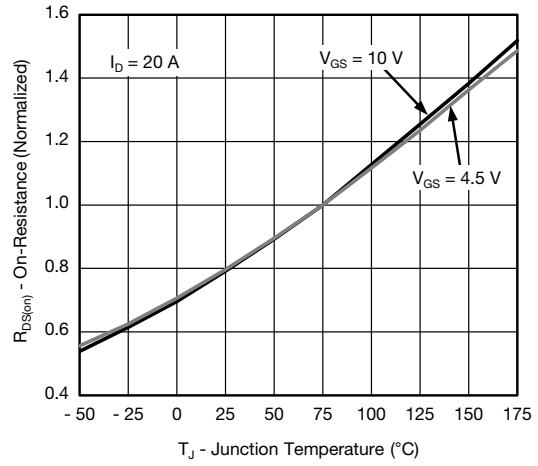

On-Resistance vs. Junction Temperature

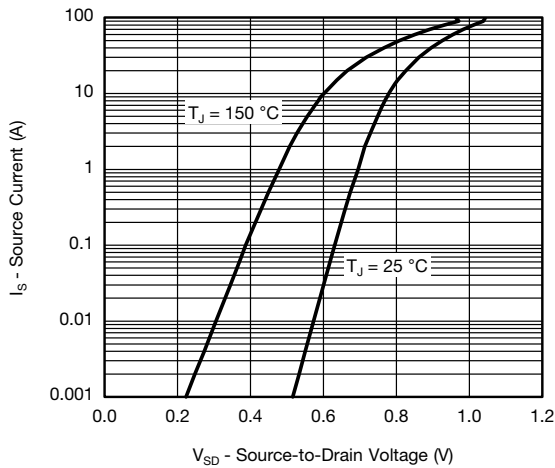

Source Drain Diode Forward Voltage

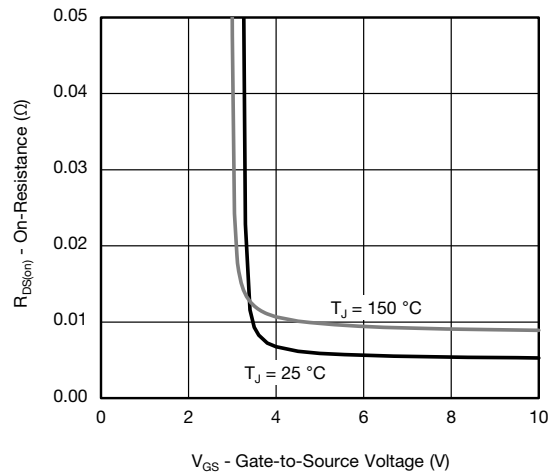

On-Resistance vs. Gate-to-Source Voltage

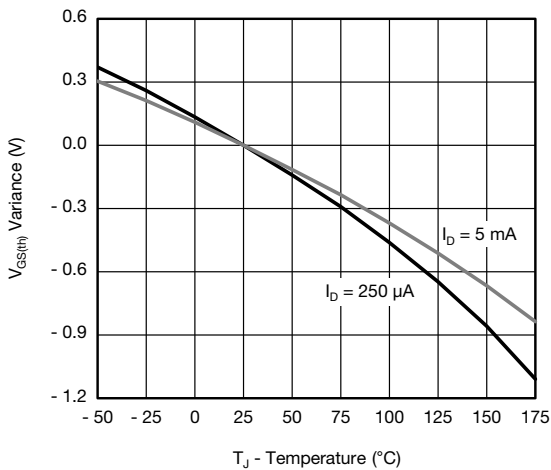

Threshold Voltage

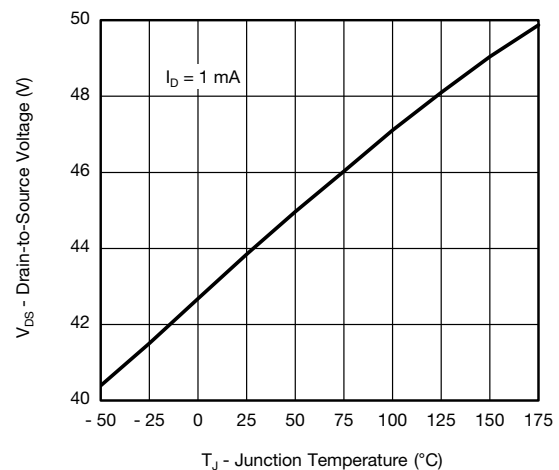

Drain Source Breakdown vs. Junction Temperature



THERMAL RATINGS ($T_A = 25\text{ }^\circ\text{C}$, unless otherwise noted)

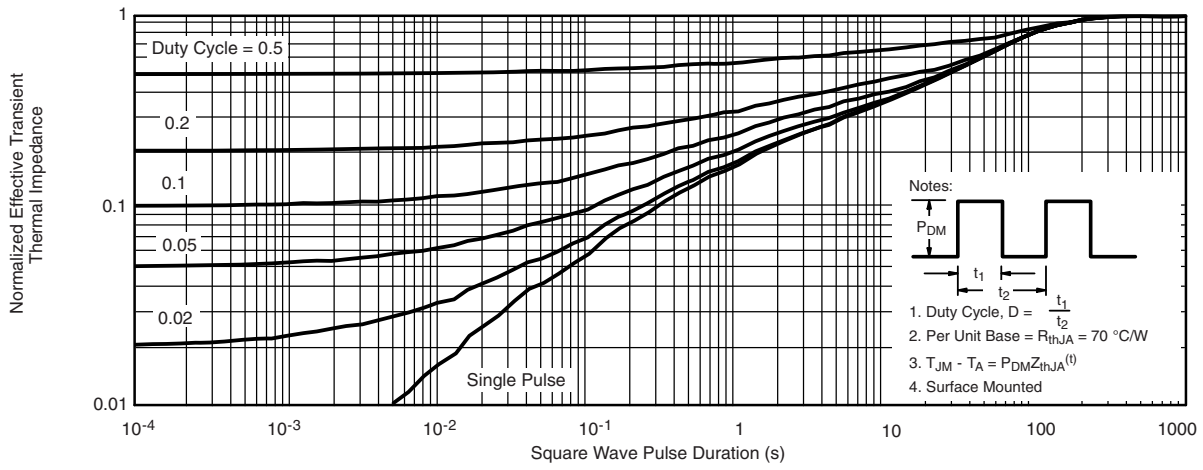
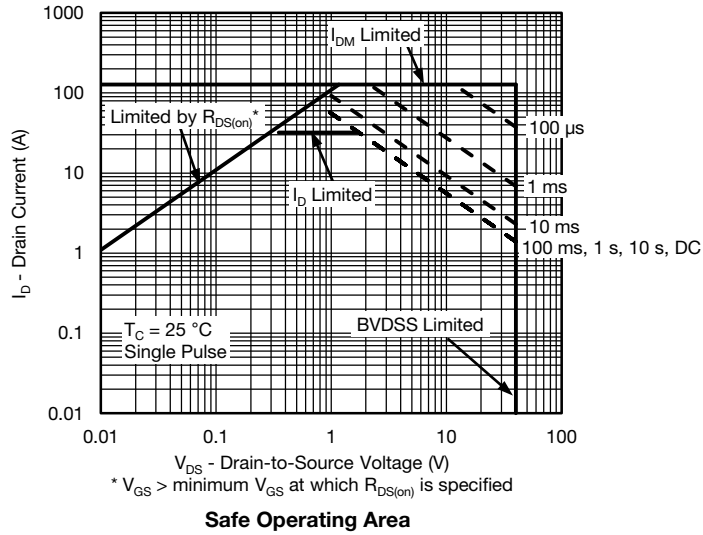

Normalized Thermal Transient Impedance, Junction-to-Ambient



THERMAL RATINGS ($T_A = 25\text{ }^\circ\text{C}$, unless otherwise noted)

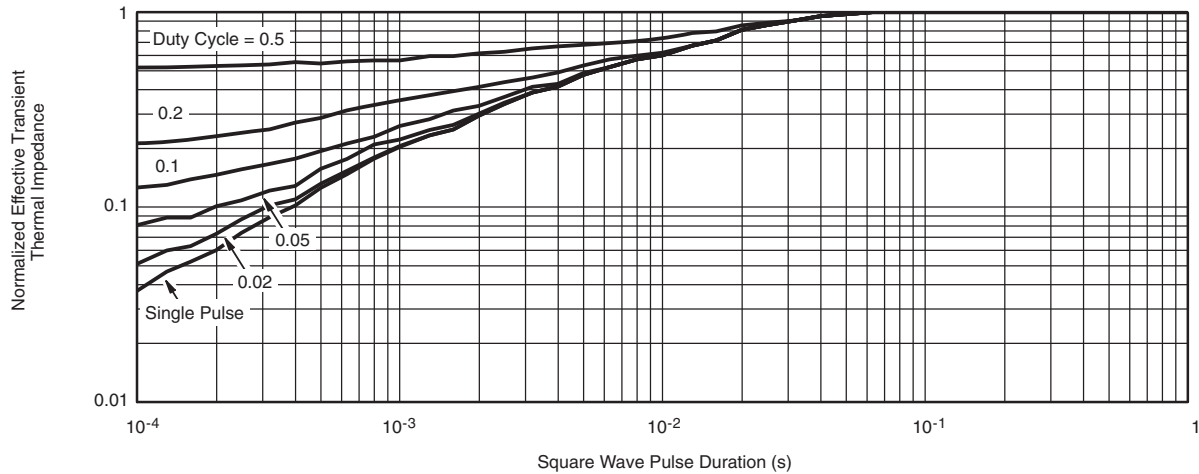

Normalized Thermal Transient Impedance, Junction-to-Case

Note

- The characteristics shown in the two graphs
 - Normalized Transient Thermal Impedance Junction-to-Ambient (25 °C)
 - Normalized Transient Thermal Impedance Junction-to-Case (25 °C)
 are given for general guidelines only to enable the user to get a “ball park” indication of part capabilities. The data are extracted from single pulse transient thermal impedance characteristics which are developed from empirical measurements. The latter is valid for the part mounted on printed circuit board - FR4, size 1" x 1" x 0.062", double sided with 2 oz. copper, 100 % on both sides. The part capabilities can widely vary depending on actual application parameters and operating conditions.

Vishay Siliconix maintains worldwide manufacturing capability. Products may be manufactured at one of several qualified locations. Reliability data for Silicon Technology and Package Reliability represent a composite of all qualified locations. For related documents such as package/tape drawings, part marking, and reliability data, see www.vishay.com/ppg?67492.



PowerPAK® SO-8L Case Outline



TOPSIDE VIEW



BACKSIDE VIEW(SINGLE)

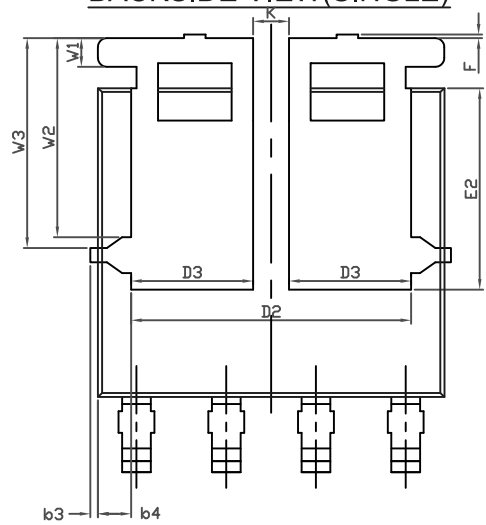

BACKSIDE VIEW(DUAL)

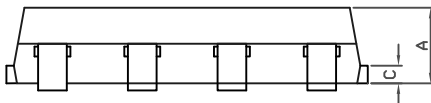



DIM.	MILLIMETERS			INCHES		
	MIN.	NOM.	MAX.	MIN.	NOM.	MAX.
A	1.00	1.07	1.14	0.039	0.042	0.045
A1	0.00	-	0.127	0.00	-	0.005
b	0.33	0.41	0.48	0.013	0.016	0.019
b1	0.44	0.51	0.58	0.017	0.020	0.023
b2	4.80	4.90	5.00	0.189	0.193	0.197
b3	0.094			0.004		
b4	0.47			0.019		
c	0.20	0.25	0.30	0.008	0.010	0.012
D	5.00	5.13	5.25	0.197	0.202	0.207
D1	4.80	4.90	5.00	0.189	0.193	0.197
D2	3.86	3.96	4.06	0.152	0.156	0.160
D3	1.63	1.73	1.83	0.064	0.068	0.072
e	1.27 BSC			0.050 BSC		
E	6.05	6.15	6.25	0.238	0.242	0.246
E1	4.27	4.37	4.47	0.168	0.172	0.176
E2 (for Al product)	2.75	2.85	2.95	0.108	0.112	0.116
E2 (for other product)	3.18	3.28	3.38	0.125	0.129	0.133
F	-	-	0.15	-	-	0.006
L	0.62	0.72	0.82	0.024	0.028	0.032
L1	0.92	1.07	1.22	0.036	0.042	0.048
K	0.51			0.020		
W	0.23			0.009		
W1	0.41			0.016		
W2	2.82			0.111		
W3	2.96			0.117		
θ	0°	-	10°	0°	-	10°
ECN: C12-0026-Rev. B, 27-Aug-12 DWG: 5976						

Note

- Millimeters will govern



RECOMMENDED MINIMUM PAD FOR PowerPAK® SO-8L SINGLE



Recommended Minimum Pads
Dimensions in mm (inches)



Disclaimer

ALL PRODUCT, PRODUCT SPECIFICATIONS AND DATA ARE SUBJECT TO CHANGE WITHOUT NOTICE TO IMPROVE RELIABILITY, FUNCTION OR DESIGN OR OTHERWISE.

Vishay Intertechnology, Inc., its affiliates, agents, and employees, and all persons acting on its or their behalf (collectively, "Vishay"), disclaim any and all liability for any errors, inaccuracies or incompleteness contained in any datasheet or in any other disclosure relating to any product.

Vishay makes no warranty, representation or guarantee regarding the suitability of the products for any particular purpose or the continuing production of any product. To the maximum extent permitted by applicable law, Vishay disclaims (i) any and all liability arising out of the application or use of any product, (ii) any and all liability, including without limitation special, consequential or incidental damages, and (iii) any and all implied warranties, including warranties of fitness for particular purpose, non-infringement and merchantability.

Statements regarding the suitability of products for certain types of applications are based on Vishay's knowledge of typical requirements that are often placed on Vishay products in generic applications. Such statements are not binding statements about the suitability of products for a particular application. It is the customer's responsibility to validate that a particular product with the properties described in the product specification is suitable for use in a particular application. Parameters provided in datasheets and/or specifications may vary in different applications and performance may vary over time. All operating parameters, including typical parameters, must be validated for each customer application by the customer's technical experts. Product specifications do not expand or otherwise modify Vishay's terms and conditions of purchase, including but not limited to the warranty expressed therein.

Except as expressly indicated in writing, Vishay products are not designed for use in medical, life-saving, or life-sustaining applications or for any other application in which the failure of the Vishay product could result in personal injury or death. Customers using or selling Vishay products not expressly indicated for use in such applications do so at their own risk. Please contact authorized Vishay personnel to obtain written terms and conditions regarding products designed for such applications.

No license, express or implied, by estoppel or otherwise, to any intellectual property rights is granted by this document or by any conduct of Vishay. Product names and markings noted herein may be trademarks of their respective owners.

Material Category Policy

Vishay Intertechnology, Inc. hereby certifies that all its products that are identified as RoHS-Compliant fulfill the definitions and restrictions defined under Directive 2011/65/EU of The European Parliament and of the Council of June 8, 2011 on the restriction of the use of certain hazardous substances in electrical and electronic equipment (EEE) - recast, unless otherwise specified as non-compliant.

Please note that some Vishay documentation may still make reference to RoHS Directive 2002/95/EC. We confirm that all the products identified as being compliant to Directive 2002/95/EC conform to Directive 2011/65/EU.

Vishay Intertechnology, Inc. hereby certifies that all its products that are identified as Halogen-Free follow Halogen-Free requirements as per JEDEC JS709A standards. Please note that some Vishay documentation may still make reference to the IEC 61249-2-21 definition. We confirm that all the products identified as being compliant to IEC 61249-2-21 conform to JEDEC JS709A standards.