

## Advanced Power MOSFET

# SSS3N90A

### FEATURES

- Avalanche Rugged Technology
- Rugged Gate Oxide Technology
- Lower Input Capacitance
- Improved Gate Charge
- Extended Safe Operating Area
- Lower Leakage Current : 25  $\mu$ A (Max.) @  $V_{DS} = 900V$
- Low  $R_{DS(ON)}$  : 4.679  $\Omega$  (Typ.)

$$BV_{DSS} = 900 V$$

$$R_{DS(on)} = 6.2 \Omega$$

$$I_D = 2 A$$

### TO-220F

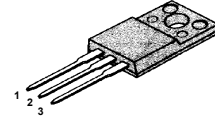

1.Gate 2. Drain 3. Source

### Absolute Maximum Ratings

Symbol	Characteristic	Value	Units
$V_{DSS}$	Drain-to-Source Voltage	900	V
$I_D$	Continuous Drain Current ( $T_C=25^\circ C$ )	2	A
	Continuous Drain Current ( $T_C=100^\circ C$ )	1.3	
$I_{DM}$	Drain Current-Pulsed ①	12	A
$V_{GS}$	Gate-to-Source Voltage	$\pm 30$	V
$E_{AS}$	Single Pulsed Avalanche Energy ②	286	mJ
$I_{AR}$	Avalanche Current ①	2	A
$E_{AR}$	Repetitive Avalanche Energy ①	3.5	mJ
dv/dt	Peak Diode Recovery dv/dt ③	1.5	V/ns
$P_D$	Total Power Dissipation ( $T_C=25^\circ C$ )	35	W
	Linear Derating Factor	0.28	
$T_J, T_{STG}$	Operating Junction and Storage Temperature Range	- 55 to +150	$^\circ C$
$T_L$	Maximum Lead Temp. for Soldering Purposes, 1/8" from case for 5-seconds	300	

### Thermal Resistance

Symbol	Characteristic	Typ.	Max.	Units
$R_{\theta JC}$	Junction-to-Case	--	3.57	$^\circ C/W$
$R_{\theta JA}$	Junction-to-Ambient	--	62.5	

### Electrical Characteristics (T<sub>C</sub>=25°C unless otherwise specified)

Symbol	Characteristic	Min.	Typ.	Max.	Units	Test Condition
BV <sub>DSS</sub>	Drain-Source Breakdown Voltage	900	--	--	V	V <sub>GS</sub> =0V, I <sub>D</sub> =250μA
ΔBV/ΔT <sub>J</sub>	Breakdown Voltage Temp. Coeff.	--	1.13	--	V/°C	I <sub>D</sub> =250μA <b>See Fig 7</b>
V <sub>GS(th)</sub>	Gate Threshold Voltage	2.0	--	3.5	V	V <sub>DS</sub> =5V, I <sub>D</sub> =250μA
I <sub>GSS</sub>	Gate-Source Leakage, Forward	--	--	100	nA	V <sub>GS</sub> =30V
	Gate-Source Leakage, Reverse	--	--	-100		V <sub>GS</sub> =-30V
I <sub>DSS</sub>	Drain-to-Source Leakage Current	--	--	25	μA	V <sub>DS</sub> =900V
		--	--	250		V <sub>DS</sub> =720V, T <sub>C</sub> =125°C
R <sub>DS(on)</sub>	Static Drain-Source On-State Resistance	--	--	6.2	Ω	V <sub>GS</sub> =10V, I <sub>D</sub> =1A ④
g <sub>fs</sub>	Forward Transconductance	--	1.78	--	S	V <sub>DS</sub> =50V, I <sub>D</sub> =1A ④
C <sub>ISS</sub>	Input Capacitance	--	590	770	pF	V <sub>GS</sub> =0V, V <sub>DS</sub> =25V, f=1MHz <b>See Fig 5</b>
C <sub>OSS</sub>	Output Capacitance	--	55	65		
C <sub>rss</sub>	Reverse Transfer Capacitance	--	22	28		
t <sub>d(on)</sub>	Turn-On Delay Time	--	16	40	ns	V <sub>DD</sub> =450V, I <sub>D</sub> =3A, R <sub>G</sub> =16Ω <b>See Fig 13</b> ④ ⑤
t <sub>r</sub>	Rise Time	--	26	60		
t <sub>d(off)</sub>	Turn-Off Delay Time	--	47	105		
t <sub>f</sub>	Fall Time	--	24	60		
Q <sub>g</sub>	Total Gate Charge	--	28	37	nC	V <sub>DS</sub> =720V, V <sub>GS</sub> =10V, I <sub>D</sub> =3A <b>See Fig 6 &amp; Fig 12</b> ④ ⑤
Q <sub>gs</sub>	Gate-Source Charge	--	5.5	--		
Q <sub>gd</sub>	Gate-Drain(米勒?) Charge	--	11.9	--		

### Source-Drain Diode Ratings and Characteristics

Symbol	Characteristic	Min.	Typ.	Max.	Units	Test Condition
I <sub>S</sub>	Continuous Source Current	--	--	2	A	Integral reverse pn-diode in the MOSFET
I <sub>SM</sub>	Pulsed-Source Current ①	--	--	12		
V <sub>SD</sub>	Diode Forward Voltage ④	--	--	1.4	V	T <sub>J</sub> =25°C, I <sub>S</sub> =2A, V <sub>GS</sub> =0V
t <sub>rr</sub>	Reverse Recovery Time	--	380	--	ns	T <sub>J</sub> =25°C, I <sub>F</sub> =3A
Q <sub>rr</sub>	Reverse Recovery Charge	--	1.9	--	μC	di <sub>F</sub> /dt=100A/μs ④

#### Notes ;

- ① Repetitive Rating : Pulse Width Limited by Maximum Junction Temperature
- ② L=135mH, I<sub>AS</sub>=2A, V<sub>DD</sub>=50V, R<sub>G</sub>=27Ω, Starting T<sub>J</sub>=25°C
- ③ I<sub>SD</sub>≤3A, di/dt≤90A/μs, V<sub>DD</sub>≤BV<sub>DSS</sub>, Starting T<sub>J</sub>=25°C
- ④ Pulse Test : Pulse Width = 250μs, Duty Cycle ≤ 2%
- ⑤ Essentially Independent of Operating Temperature

**Fig 1. Output Characteristics**

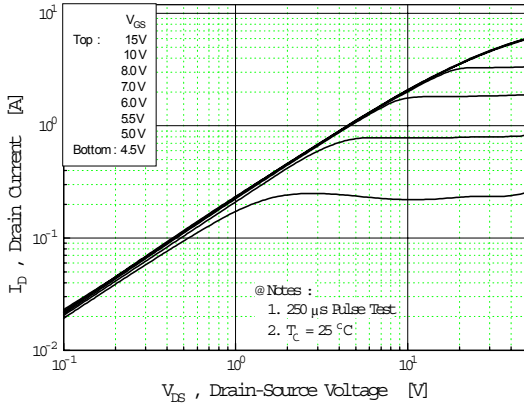

**Fig 2. Transfer Characteristics**

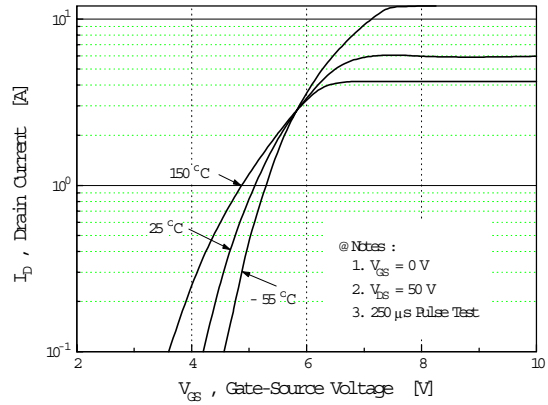

**Fig 3. On-Resistance vs. Drain Current**

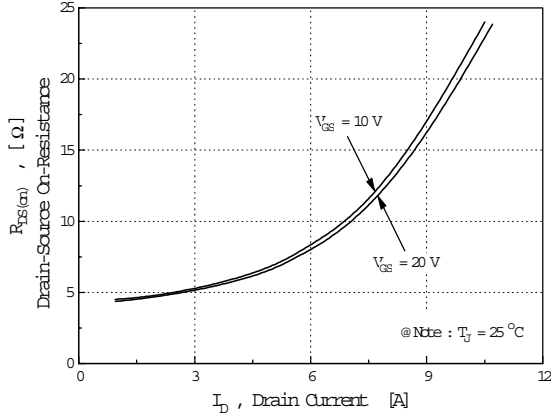

**Fig 4. Source-Drain Diode Forward Voltage**

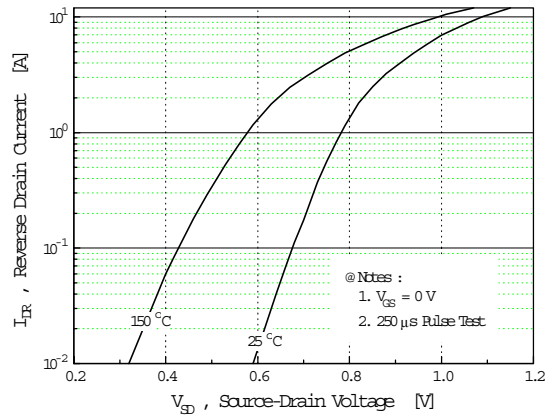

**Fig 5. Capacitance vs. Drain-Source Voltage**

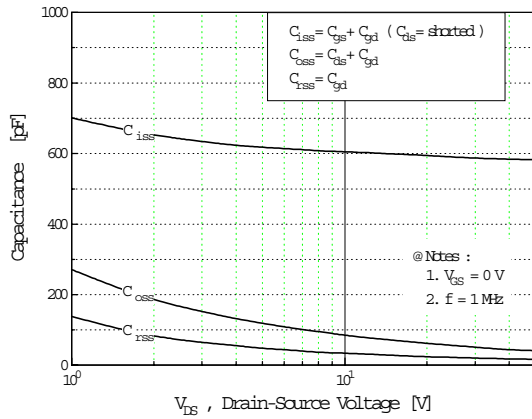

**Fig 6. Gate Charge vs. Gate-Source Voltage**

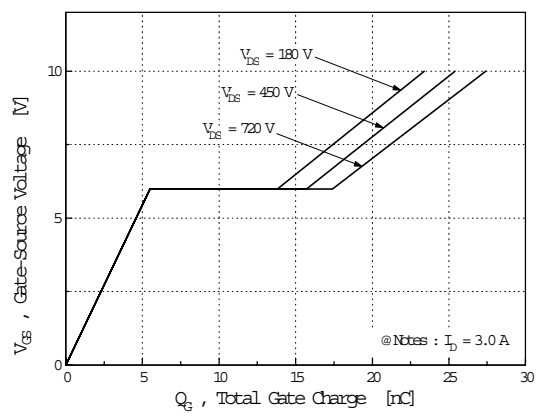

**Fig 7. Breakdown Voltage vs. Temperature**

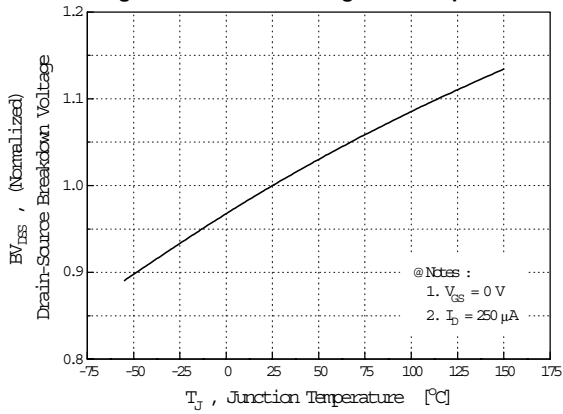

**Fig 8. On-Resistance vs. Temperature**

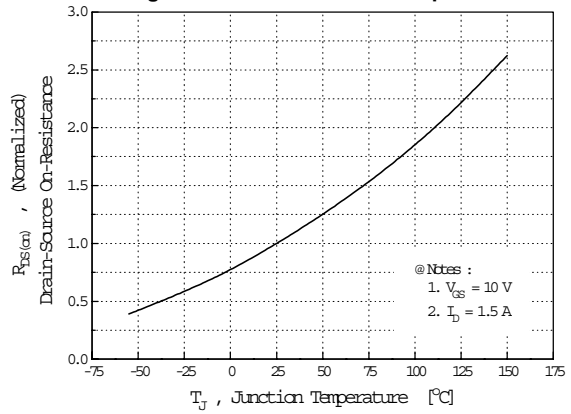

**Fig 9. Max. Safe Operating Area**

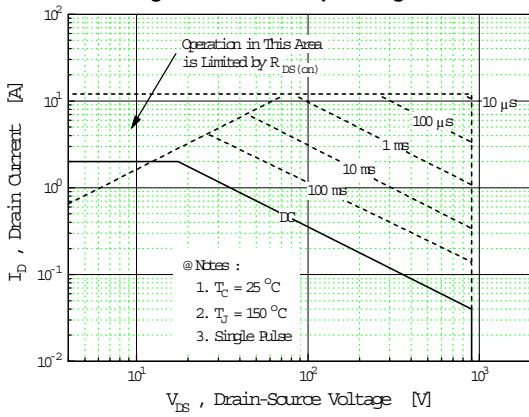

**Fig 10. Max. Drain Current vs. Case Temperature**

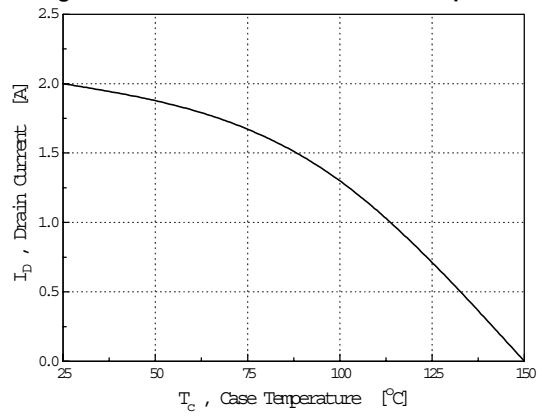

**Fig 11. Thermal Response**

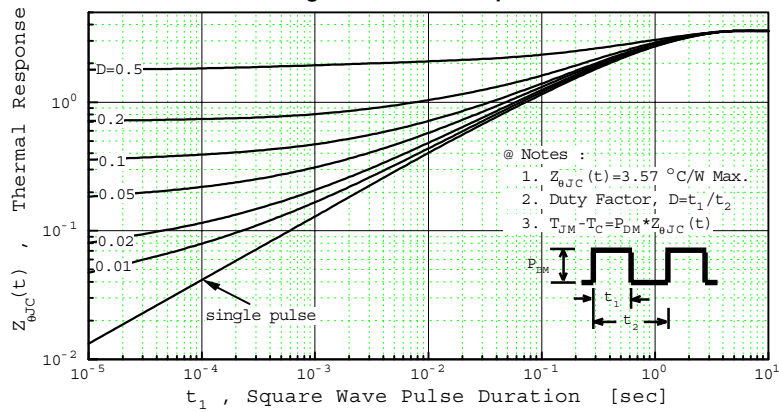

**Fig 12. Gate Charge Test Circuit & Waveform**

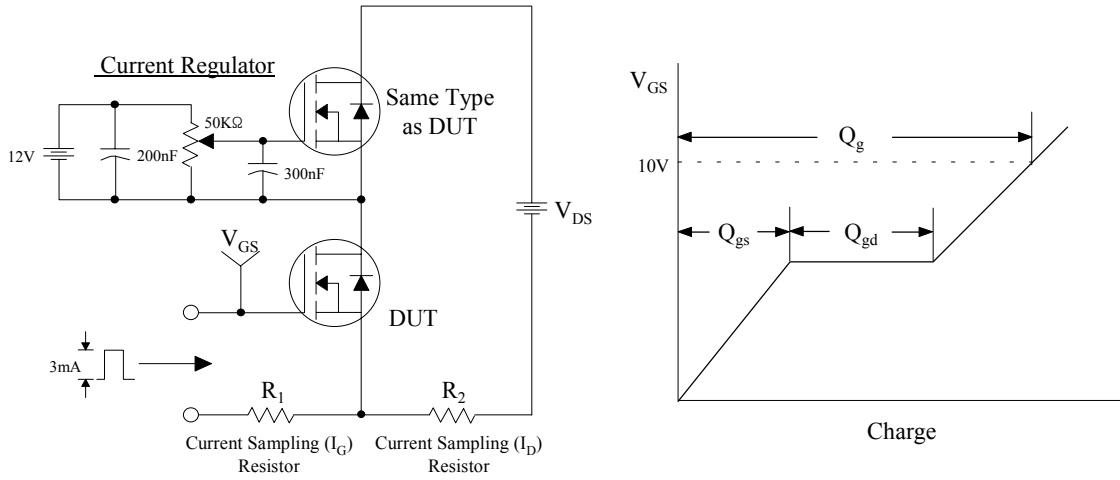

**Fig 13. Resistive Switching Test Circuit & Waveforms**

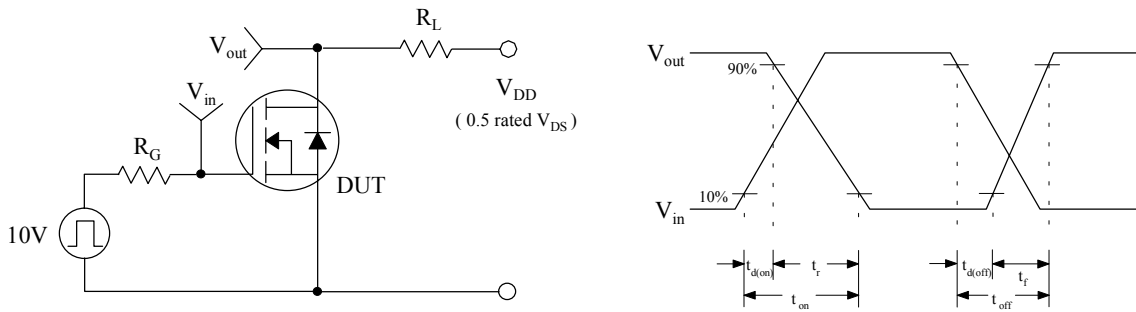

**Fig 14. Unclamped Inductive Switching Test Circuit & Waveforms**

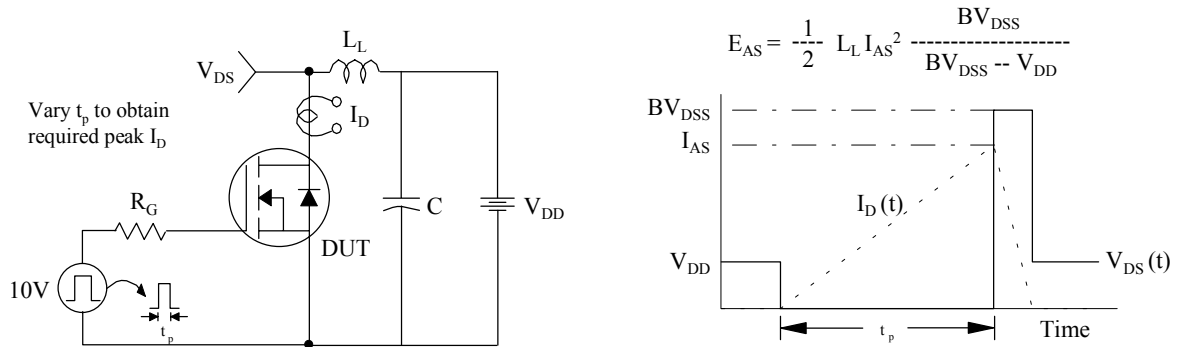

Fig 15. Peak Diode Recovery dv/dt Test Circuit & Waveforms

