

## N - CHANNEL ENHANCEMENT MODE FAST POWER MOS TRANSISTOR

TYPE	V <sub>DSS</sub>	R <sub>DS(on)</sub>	I <sub>D</sub>
STH15NA50	500 V	< 0.4 Ω	14.6 A
STH15NA50FI	500 V	< 0.4 Ω	9.3 A
STW15NA50	500 V	< 0.4 Ω	14.6 A

- TYPICAL R<sub>DS(on)</sub> = 0.33 Ω
- ± 30V GATE TO SOURCE VOLTAGE RATING
- 100% AVALANCHE TESTED
- REPETITIVE AVALANCHE DATA AT 100°C
- LOW INTRINSIC CAPACITANCES
- GATE CHARGE MINIMIZED
- REDUCED THRESHOLD VOLTAGE SPREAD

### DESCRIPTION

This series of POWER MOSFETS represents the most advanced high voltage technology. The optimized cell layout coupled with a new proprietary edge termination concur to give the device low R<sub>DS(on)</sub> and gate charge, unequalled ruggedness and superior switching performance.

### APPLICATIONS

- HIGH CURRENT, HIGH SPEED SWITCHING
- SWITCH MODE POWER SUPPLIES (SMPS)
- DC-AC CONVERTERS FOR WELDING EQUIPMENT AND UNINTERRUPTIBLE POWER SUPPLIES AND MOTOR DRIVE

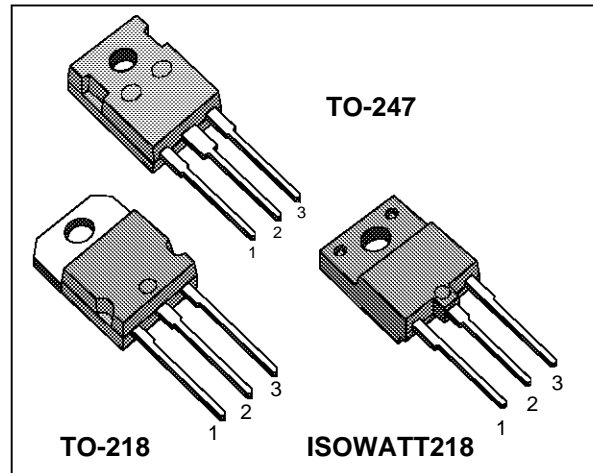

### INTERNAL SCHEMATIC DIAGRAM

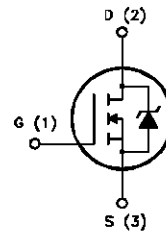

### ABSOLUTE MAXIMUM RATINGS

Symbol	Parameter	Value		Unit
		STH/STW15NA50	STH15NA50FI	
V <sub>DS</sub>	Drain-source Voltage (V <sub>GS</sub> = 0)	500		V
V <sub>DGR</sub>	Drain- gate Voltage (R <sub>GS</sub> = 20 kΩ)	500		V
V <sub>GS</sub>	Gate-source Voltage	± 30		V
I <sub>D</sub>	Drain Current (continuous) at T <sub>c</sub> = 25 °C	14.6	9.3	A
I <sub>D</sub>	Drain Current (continuous) at T <sub>c</sub> = 100 °C	9.2	5.5	A
I <sub>DM</sub> (●)	Drain Current (pulsed)	58.4	58.4	A
P <sub>tot</sub>	Total Dissipation at T <sub>c</sub> = 25 °C	190	80	W
	Derating Factor	1.52	0.64	W/°C
V <sub>ISO</sub>	Insulation Withstand Voltage (DC)	—	4000	V
T <sub>stg</sub>	Storage Temperature	-65 to 150		°C
T <sub>j</sub>	Max. Operating Junction Temperature	150		°C

(●) Pulse width limited by safe operating area

## STH15NA50/FI - STW15NA50

### THERMAL DATA

			TO-218/TO-247	ISOWATT218	
R <sub>thj-case</sub>	Thermal Resistance Junction-case	Max	0.66	1.56	°C/W
R <sub>thj-amb</sub>	Thermal Resistance Junction-ambient	Max	30		°C/W
R <sub>thc-sink</sub>	Thermal Resistance Case-sink	Typ	0.1		°C/W
T <sub>l</sub>	Maximum Lead Temperature For Soldering Purpose		300		°C

### AVALANCHE CHARACTERISTICS

Symbol	Parameter	Max Value	Unit
I <sub>AR</sub>	Avalanche Current, Repetitive or Not-Repetitive (pulse width limited by T <sub>j</sub> max, δ < 1%)	14.6	A
E <sub>AS</sub>	Single Pulse Avalanche Energy (starting T <sub>j</sub> = 25 °C, I <sub>D</sub> = I <sub>AR</sub> , V <sub>DD</sub> = 50 V)	850	mJ
E <sub>AR</sub>	Repetitive Avalanche Energy (pulse width limited by T <sub>j</sub> max, δ < 1%)	30	mJ
I <sub>AR</sub>	Avalanche Current, Repetitive or Not-Repetitive (T <sub>c</sub> = 100 °C, pulse width limited by T <sub>j</sub> max, δ < 1%)	9.2	A

### ELECTRICAL CHARACTERISTICS (T<sub>case</sub> = 25 °C unless otherwise specified)

OFF

Symbol	Parameter	Test Conditions	Min.	Typ.	Max.	Unit
V <sub>(BR)DSS</sub>	Drain-source Breakdown Voltage	I <sub>D</sub> = 250 μA V <sub>GS</sub> = 0	500			V
I <sub>DSS</sub>	Zero Gate Voltage Drain Current (V <sub>GS</sub> = 0)	V <sub>DS</sub> = Max Rating V <sub>DS</sub> = Max Rating x 0.8 T <sub>c</sub> = 125 °C			25 250	μA μA
I <sub>GSS</sub>	Gate-body Leakage Current (V <sub>DS</sub> = 0)	V <sub>GS</sub> = ± 30 V			± 100	nA

ON (\*)

Symbol	Parameter	Test Conditions	Min.	Typ.	Max.	Unit
V <sub>GS(th)</sub>	Gate Threshold Voltage	V <sub>DS</sub> = V <sub>GS</sub> I <sub>D</sub> = 250 μA	2.25	3	3.75	V
R <sub>DS(on)</sub>	Static Drain-source On Resistance	V <sub>GS</sub> = 10V I <sub>D</sub> = 7.5 A		0.33	0.4	Ω
I <sub>D(on)</sub>	On State Drain Current	V <sub>DS</sub> > I <sub>D(on)</sub> x R <sub>DS(on)max</sub> V <sub>GS</sub> = 10 V	14.6			A

DYNAMIC

Symbol	Parameter	Test Conditions	Min.	Typ.	Max.	Unit
g <sub>fs</sub> (*)	Forward Transconductance	V <sub>DS</sub> > I <sub>D(on)</sub> x R <sub>DS(on)max</sub> I <sub>D</sub> = 7.5 A	9	13		S
C <sub>iss</sub>	Input Capacitance	V <sub>DS</sub> = 25 V f = 1 MHz V <sub>GS</sub> = 0		2500	3250	pF
C <sub>oss</sub>	Output Capacitance			345	450	pF
C <sub>rss</sub>	Reverse Transfer Capacitance			105	140	pF

**ELECTRICAL CHARACTERISTICS** (continued)

**SWITCHING ON**

Symbol	Parameter	Test Conditions	Min.	Typ.	Max.	Unit
$t_{d(on)}$ $t_r$	Turn-on Time Rise Time	$V_{DD} = 225\text{ V}$ $I_D = 7.5\text{ A}$ $R_G = 4.7\ \Omega$ $V_{GS} = 10\text{ V}$ (see test circuit, figure 3)		24 37	34 50	ns ns
$(di/dt)_{on}$	Turn-on Current Slope	$V_{DD} = 400\text{ V}$ $I_D = 15\text{ A}$ $R_G = 47\ \Omega$ $V_{GS} = 10\text{ V}$ (see test circuit, figure 5)		225		A/ $\mu$ s
$Q_g$ $Q_{gs}$ $Q_{gd}$	Total Gate Charge Gate-Source Charge Gate-Drain Charge	$V_{DD} = 400\text{ V}$ $I_D = 15\text{ A}$ $V_{GS} = 10\text{ V}$		110 15 55	140	nC nC nC

**SWITCHING OFF**

Symbol	Parameter	Test Conditions	Min.	Typ.	Max.	Unit
$t_{r(Voff)}$ $t_f$ $t_c$	Off-voltage Rise Time Fall Time Cross-over Time	$V_{DD} = 400\text{ V}$ $I_D = 15\text{ A}$ $R_G = 4.7\ \Omega$ $V_{GS} = 10\text{ V}$ (see test circuit, figure 5)		25 17 45	35 24 60	ns ns ns

**SOURCE DRAIN DIODE**

Symbol	Parameter	Test Conditions	Min.	Typ.	Max.	Unit
$I_{SD}$ $I_{SDM}(\bullet)$	Source-drain Current Source-drain Current (pulsed)				14.6 58.4	A A
$V_{SD} (*)$	Forward On Voltage	$I_{SD} = 15\text{ A}$ $V_{GS} = 0$			1.6	V
$t_{rr}$ $Q_{rr}$ $I_{RRM}$	Reverse Recovery Time Reverse Recovery Charge Reverse Recovery Current	$I_{SD} = 15\text{ A}$ $di/dt = 100\text{ A}/\mu\text{s}$ $V_{DD} = 100\text{ V}$ $T_j = 150\text{ }^\circ\text{C}$ (see test circuit, figure 5)		640 12.8 40		ns $\mu$ C A

(\*) Pulsed: Pulse duration = 300  $\mu$ s, duty cycle 1.5%

( $\bullet$ ) Pulse width limited by safe operating area

Safe Operating Areas For TO-218 and TO-247

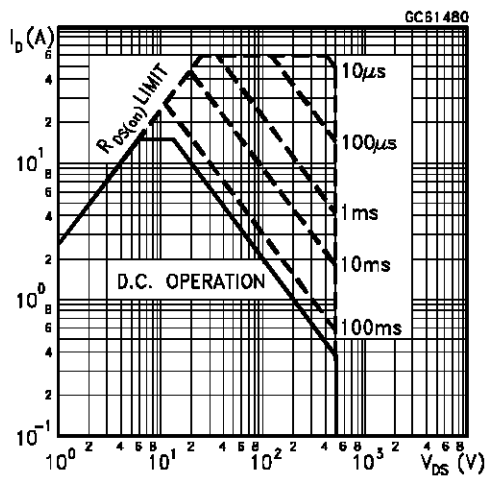

Safe Operating Areas For ISOWATT218

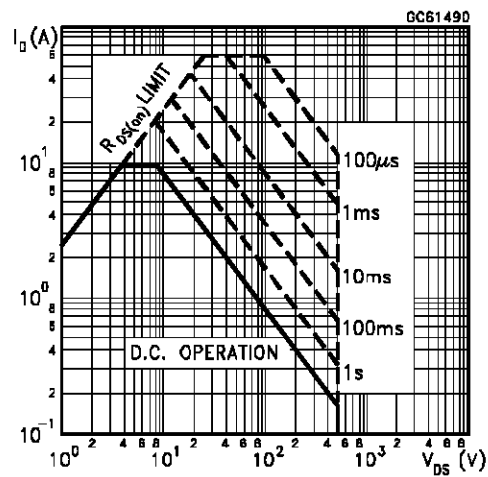

# STH15NA50/FI - STW15NA50

Thermal Impedance For TO-218 and TO-247

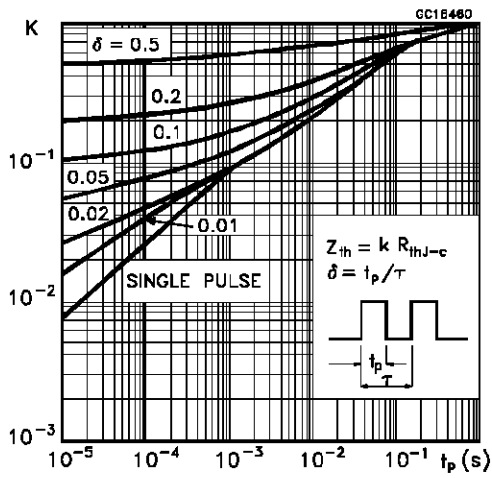

Thermal Impedance For ISOWATT218

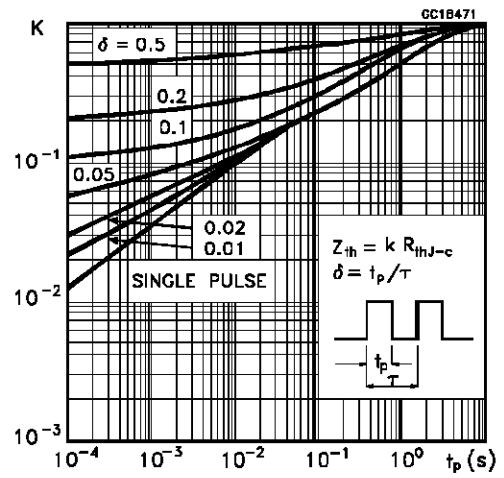

Derating Curve For TO-218 and TO-247

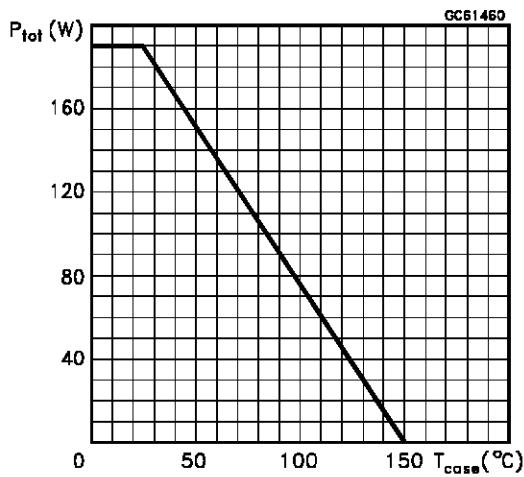

Derating Curve For ISOWATT218

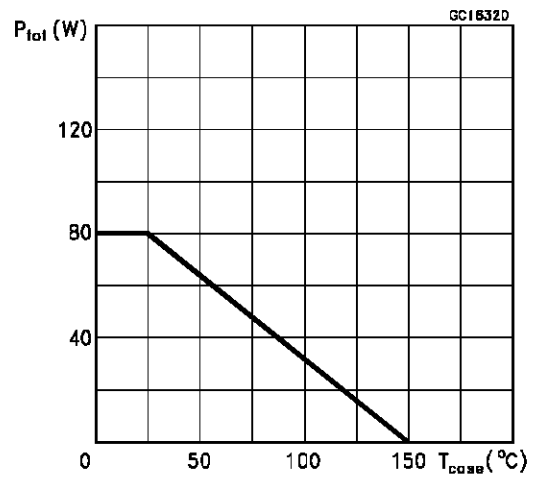

Output Characteristics

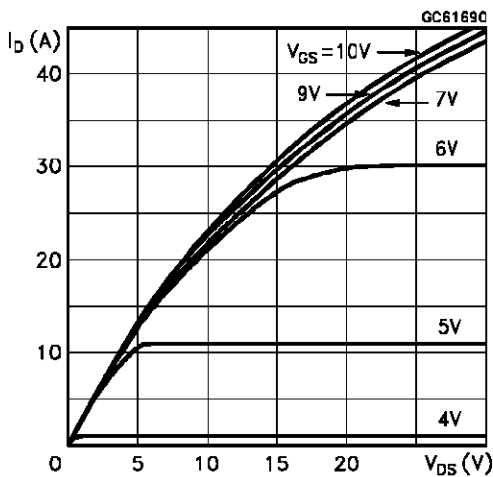

Transfer Characteristics

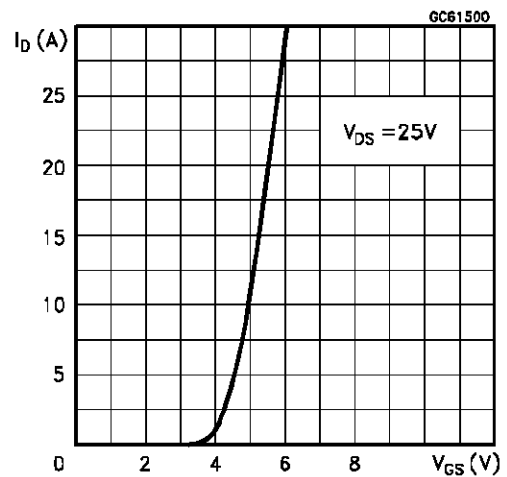

Transconductance

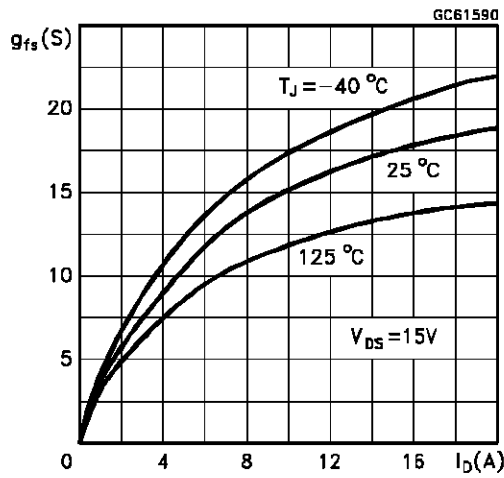

Static Drain-source On Resistance

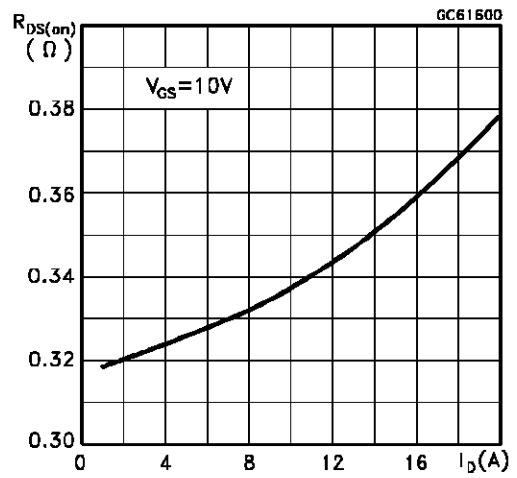

Gate Charge vs Gate-source Voltage

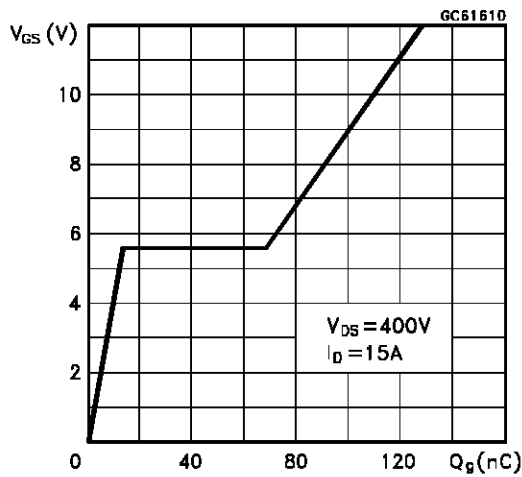

Capacitance Variations

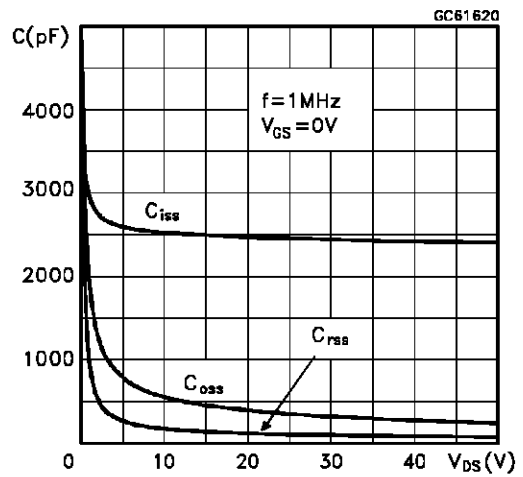

Normalized Gate Threshold Voltage vs Temperature

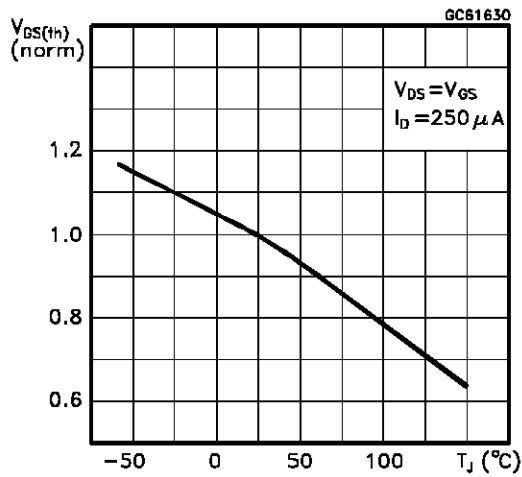

Normalized On Resistance vs Temperature

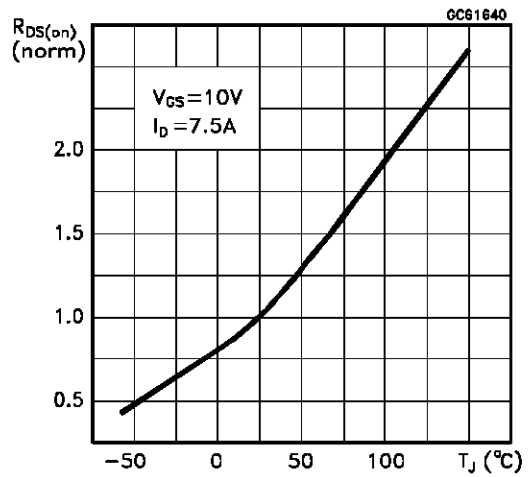

Turn-on Current Slope

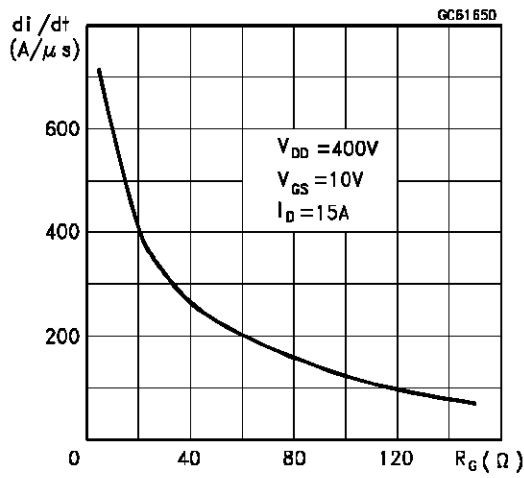

Turn-off Drain-source Voltage Slope

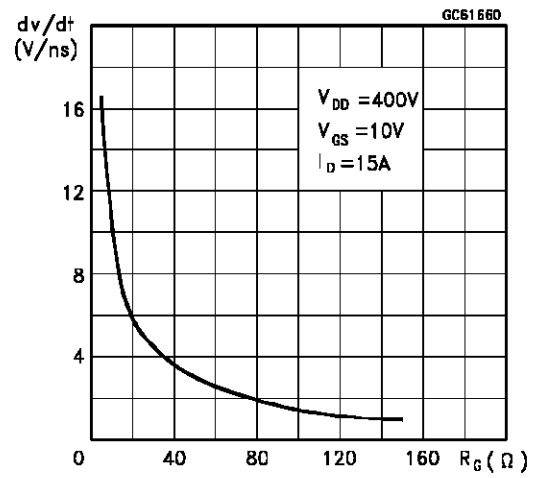

Cross-over Time

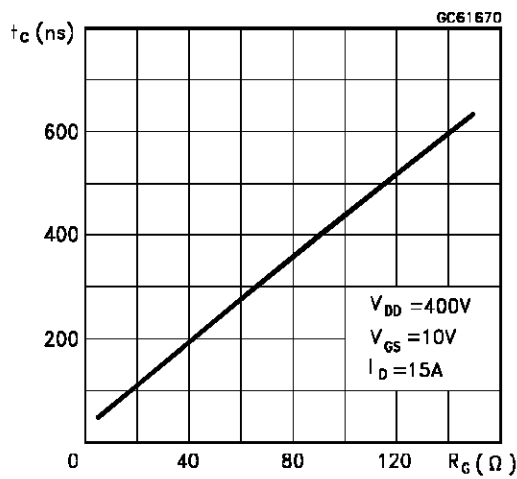

Switching Safe Operating Area

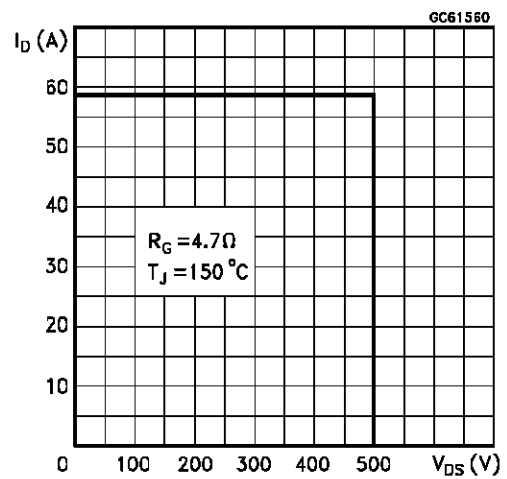

Accidental Overload Area

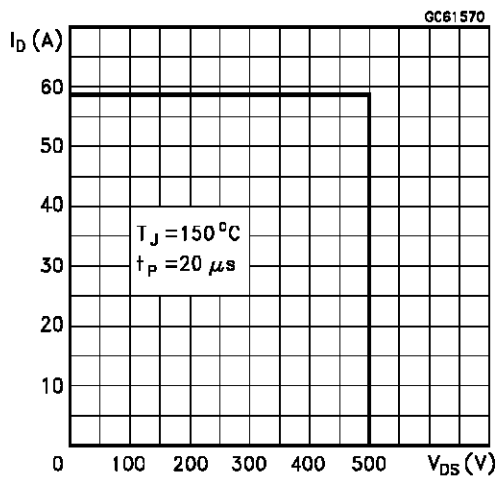

Source-drain Diode Forward Characteristics

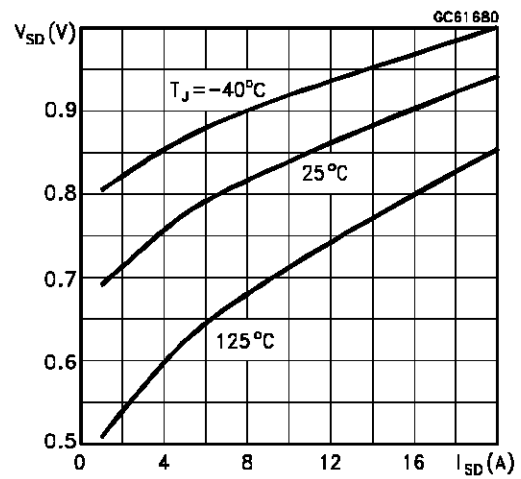

**Fig. 1: Unclamped Inductive Load Test Circuits**



**Fig. 2: Unclamped Inductive Waveforms**



**Fig. 3: Switching Times Test Circuits For Resistive Load**



**Fig. 4: Gate Charge Test Circuit**

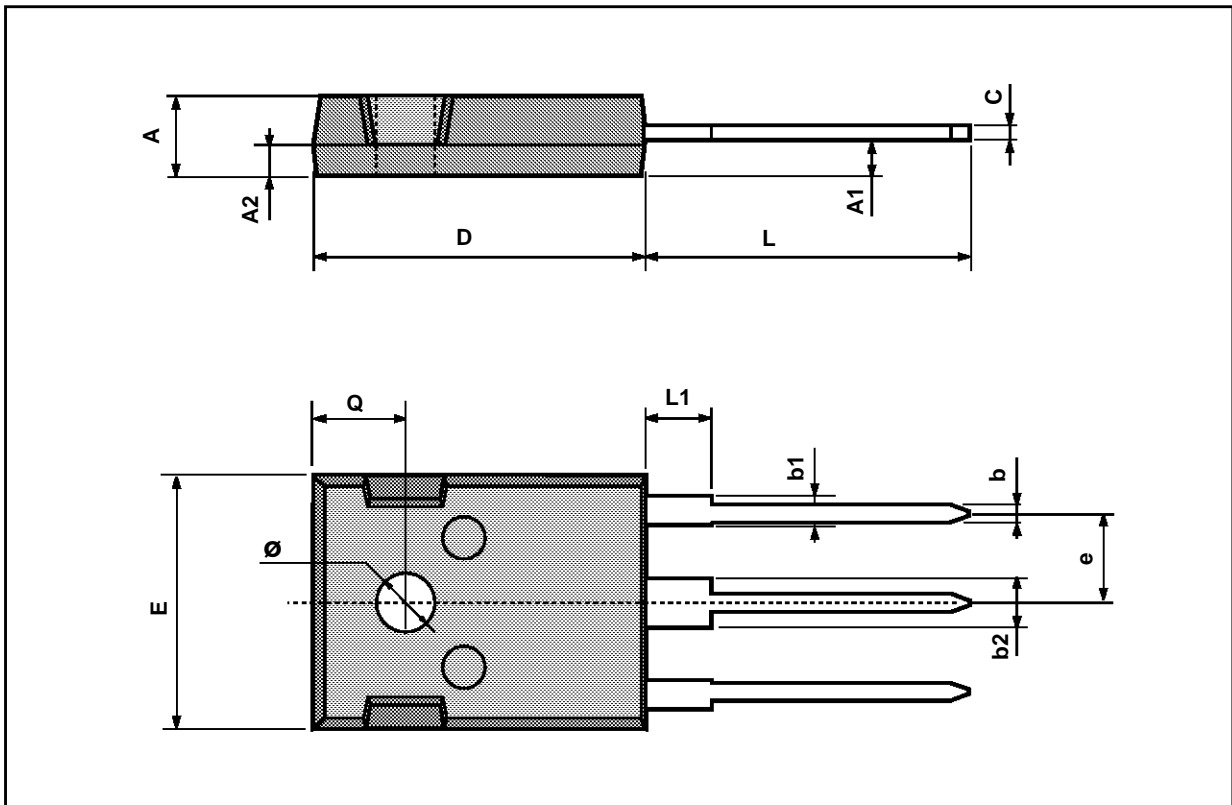

**Fig. 5: Test Circuit For Inductive Load Switching And Diode Reverse Recovery Time**



**TO-247 MECHANICAL DATA**

DIM.	mm			inch		
	MIN.	TYP.	MAX.	MIN.	TYP.	MAX.
A	4.7		5.3	0.185		0.208
A1			2.87			0.113
A2	1.5		2.5	0.059		0.098
b	1		1.4	0.039		0.055
b1			2.25			0.088
b2	3.05		3.43	0.120		0.135
C	0.4		0.8	0.015		0.031
D	20.4		21.18	0.803		0.833
e	5.43		5.47	0.213		0.215
E	15.3		15.95	0.602		0.628
L	15.57			0.613		
L1	3.7		4.3	0.145		0.169
Q	5.3		5.84	0.208		0.230
ØP	3.5		3.71	0.137		0.146





**TO-218 (SOT-93) MECHANICAL DATA**

DIM.	mm			inch		
	MIN.	TYP.	MAX.	MIN.	TYP.	MAX.
A	4.7		4.9	0.185		0.193
C	1.17		1.37	0.046		0.054
D		2.5			0.098	
E	0.5		0.78	0.019		0.030
F	1.1		1.3	0.043		0.051
G	10.8		11.1	0.425		0.437
H	14.7		15.2	0.578		0.598
L2	-		16.2	-		0.637
L3		18			0.708	
L5	3.95		4.15	0.155		0.163
L6		31			1.220	
R	-		12.2	-		0.480
Ø	4		4.1	0.157		0.161

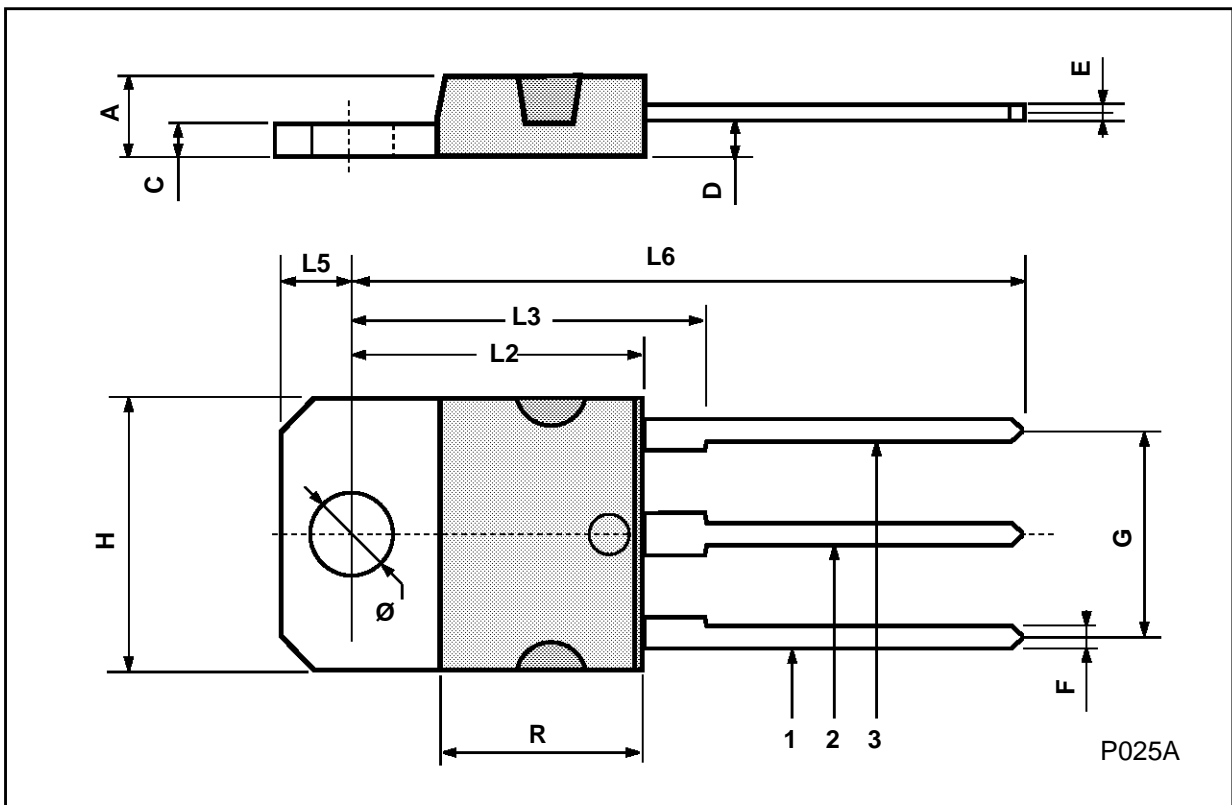

**ISOWATT218 MECHANICAL DATA**

DIM.	mm			inch		
	MIN.	TYP.	MAX.	MIN.	TYP.	MAX.
A	5.35		5.65	0.210		0.222
C	3.3		3.8	0.130		0.149
D	2.9		3.1	0.114		0.122
D1	1.88		2.08	0.074		0.081
E	0.45		1	0.017		0.039
F	1.05		1.25	0.041		0.049
G	10.8		11.2	0.425		0.441
H	15.8		16.2	0.622		0.637
L1	20.8		21.2	0.818		0.834
L2	19.1		19.9	0.752		0.783
L3	22.8		23.6	0.897		0.929
L4	40.5		42.5	1.594		1.673
L5	4.85		5.25	0.190		0.206
L6	20.25		20.75	0.797		0.817
M	3.5		3.7	0.137		0.145
N	2.1		2.3	0.082		0.090
U		4.6			0.181	

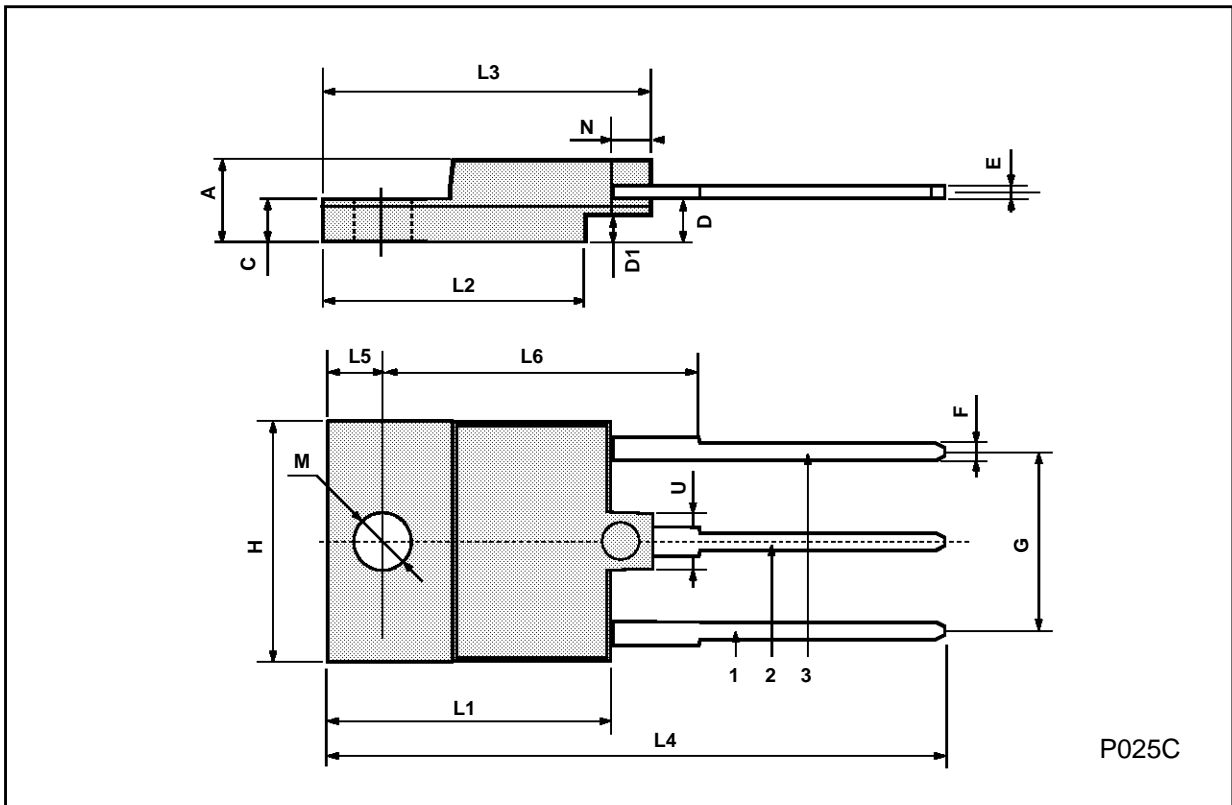

Information furnished is believed to be accurate and reliable. However, SGS-THOMSON Microelectronics assumes no responsibility for the consequences of use of such information nor for any infringement of patents or other rights of third parties which may result from its use. No license is granted by implication or otherwise under any patent or patent rights of SGS-THOMSON Microelectronics. Specifications mentioned in this publication are subject to change without notice. This publication supersedes and replaces all information previously supplied. SGS-THOMSON Microelectronics products are not authorized for use as critical components in life support devices or systems without express written approval of SGS-THOMSON Microelectronics.

© 1996 SGS-THOMSON Microelectronics - Printed in Italy - All Rights Reserved

SGS-THOMSON Microelectronics GROUP OF COMPANIES

Australia - Brazil - Canada - China - France - Germany - Hong Kong - Italy - Japan - Korea - Malaysia - Malta - Morocco - The Netherlands - Singapore - Spain - Sweden - Switzerland - Taiwan - Thailand - United Kingdom - U.S.A