



General Description

AFN8471, N-Channel enhancement mode MOSFET, uses Advanced Trench Technology to provide excellent $R_{DS(ON)}$, low gate charge.

These devices are particularly suited for low voltage power management, and low in-line power loss are needed in commercial industrial surface mount applications.

Features

- 60V/5.8A, $R_{DS(ON)}=54m\Omega@V_{GS}=10V$
- 60V/4.6A, $R_{DS(ON)}=60m\Omega@V_{GS}=4.5V$
- Super high density cell design for extremely low $R_{DS(ON)}$
- SOT-223 package design

Pin Description (SOT-223)

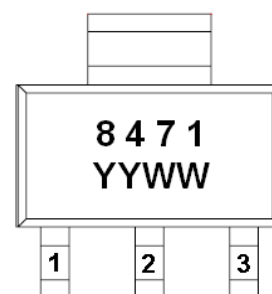
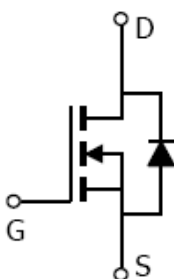
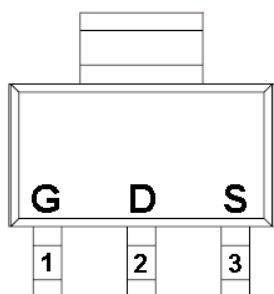

Application

- Motor and Load Control
- Power Management in White LED System
- Push Pull Converter
- LCD TV Inverter & AD/DC Inverter Systems.

Pin Define

Pin	Symbol	Description
1	G	Gate
2	D	Drain
3	S	Source

Ordering Information

Part Ordering No.	Part Marking	Package	Unit	Quantity
AFN8471S223RG	8471	SOT-223	Tape & Reel	2500 EA

※ YY year code

※ WW week code

※ AFN8471S223RG : 13" Tape & Reel ; Pb- Free ; Halogen- Free



Absolute Maximum Ratings

(T_A=25°C Unless otherwise noted)

Parameter	Symbol	Typical	Unit
Drain-Source Voltage	V _{DSS}	60	V
Gate –Source Voltage	V _{GSS}	±20	V
Continuous Drain Current(T _J =150°C)	I _D	T _A =25°C	5.8
		T _A =70°C	4.2
Pulsed Drain Current	I _{DM}	10	A
Continuous Source Current(Diode Conduction)	I _S	1.6	A
Power Dissipation	P _D	T _A =25°C	2.8
		T _A =70°C	1.2
Operating Junction Temperature	T _J	150	°C
Storage Temperature Range	T _{STG}	-55/150	°C
Thermal Resistance-Junction to Ambient	R _{θJA}	120	°C/W

Electrical Characteristics

(T_A=25°C Unless otherwise noted)

Parameter	Symbol	Conditions	Min.	Typ	Max.	Unit
Static						
Drain-Source Breakdown Voltage	V _{(BR)DSS}	V _{GS} =0V, I _D =250uA	60			V
Gate Threshold Voltage	V _{GS(th)}	V _{DS} =V _{GS} , I _D =250uA	1.0		2.5	V
Gate Leakage Current	I _{GSS}	V _{DS} =0V, V _{GS} =±20V			±100	nA
Zero Gate Voltage Drain Current	I _{DSS}	V _{DS} =60V, V _{GS} =0V			1	uA
		V _{DS} =60V, V _{GS} =0V T _J =85°C			5	
On-State Drain Current	I _{D(on)}	V _{DS} ≥ 5V, V _{GS} =4.5V	10			A
Drain-Source On-Resistance	R _{DS(on)}	V _{GS} =10V, I _D =5.8A		48	54	mΩ
		V _{GS} =4.5V, I _D =4.2A		54	60	
Forward Transconductance	g _{FS}	V _{DS} =15V, I _D =2.4A		24		S
Diode Forward Voltage	V _{SD}	I _S =1.6A, V _{GS} =0V		0.8	1.2	V
Dynamic						
Total Gate Charge	Q _g	V _{DS} =30V, V _{GS} =5V I _D ≧3.0A		10	15	nC
Gate-Source Charge	Q _{gs}			3.5		
Gate-Drain Charge	Q _{gd}			3.6		
Input Capacitance	C _{iss}	V _{DS} =30V, V _{GS} =0V f=1MHz		890		pF
Output Capacitance	C _{oss}			85		
Reverse Transfer Capacitance	C _{rss}			48		
Turn-On Time	t _{d(on)}	V _{DD} =30V, R _L =6.8Ω I _D ≧3.0A, V _{GEN} =4.5V		10	15	ns
	t _r			12	20	
Turn-Off Time	t _{d(off)}			25	35	
	t _f		R _G =6Ω		10	



Typical Characteristics

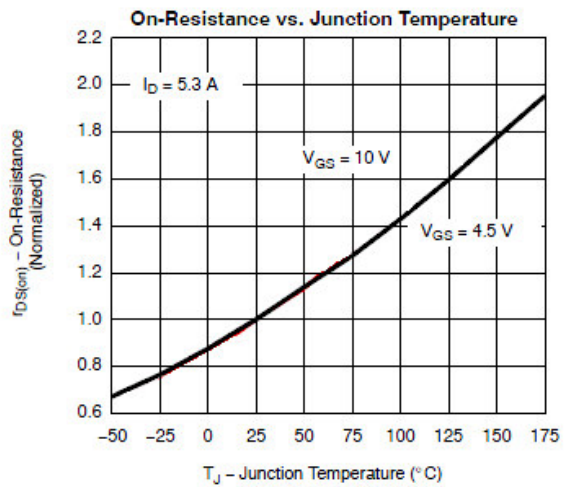
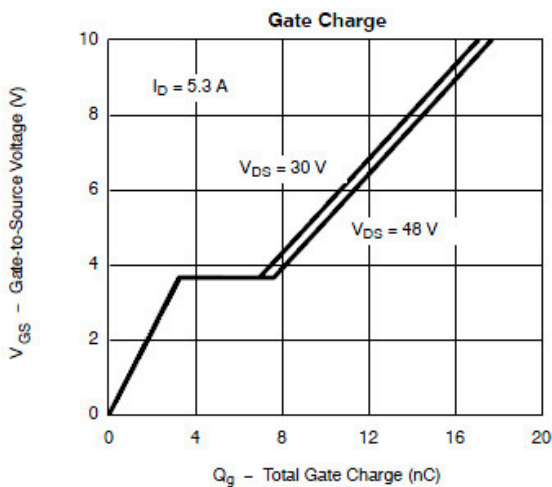
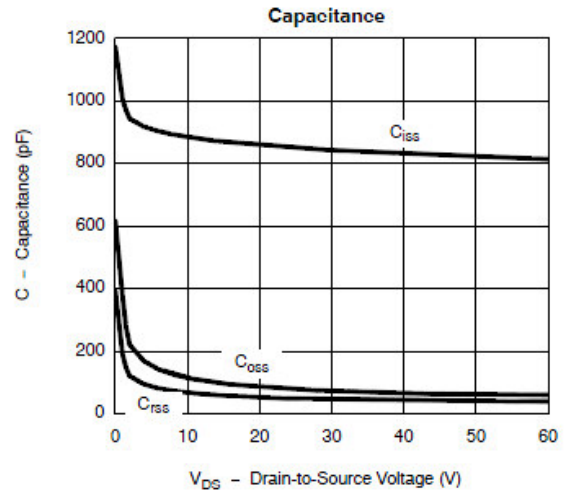
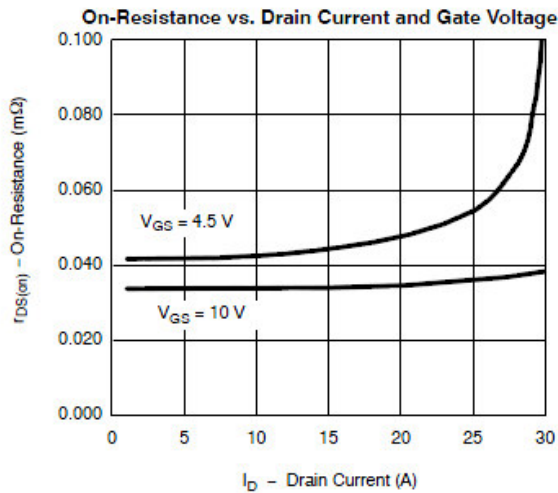
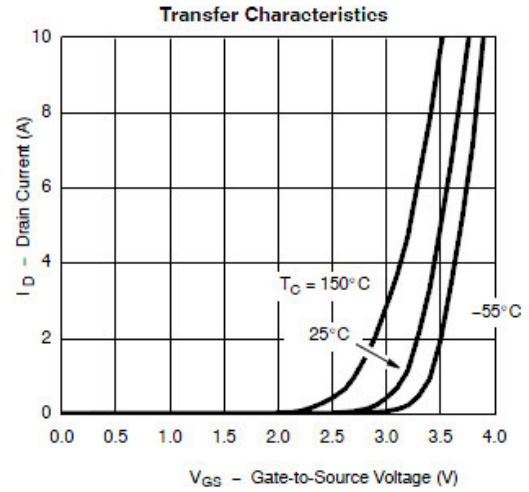
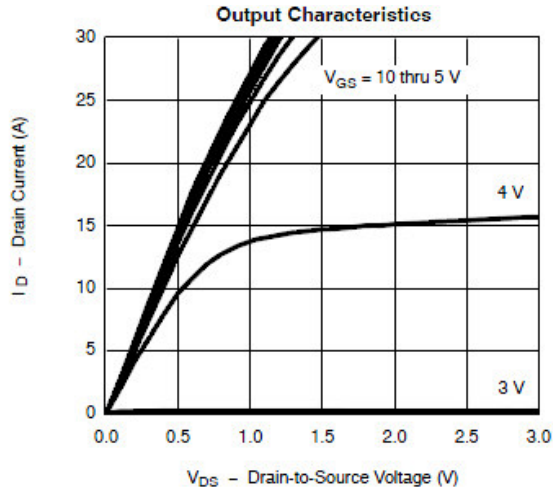



Typical Characteristics

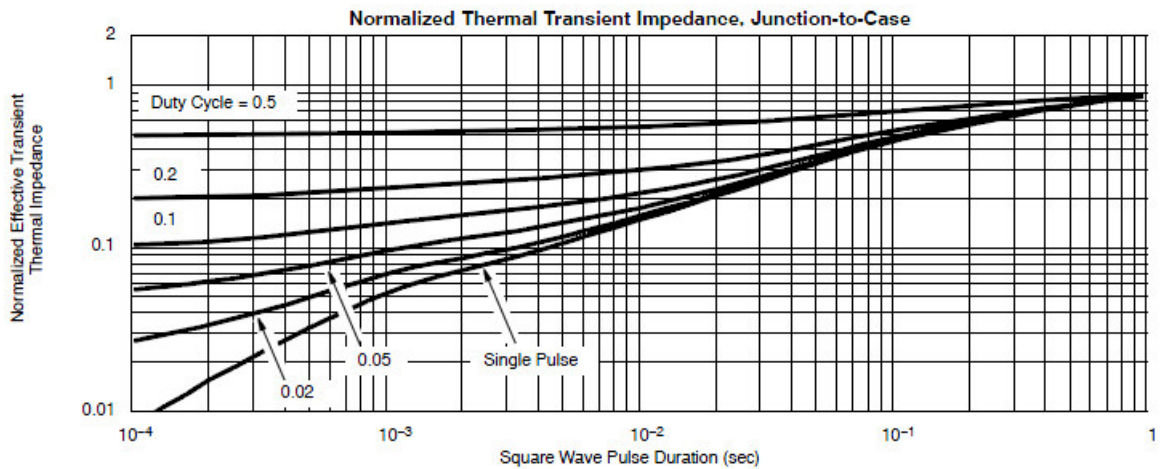
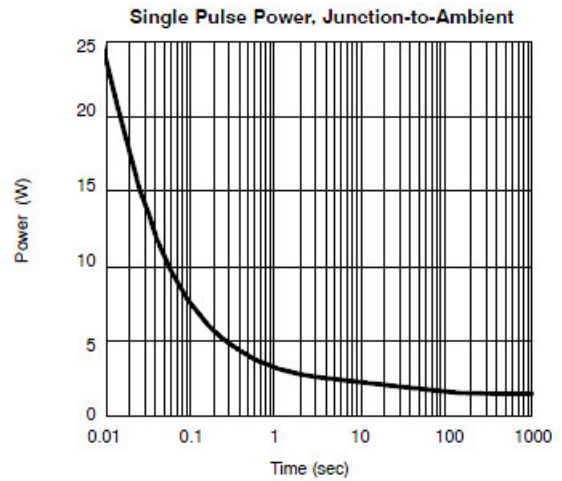
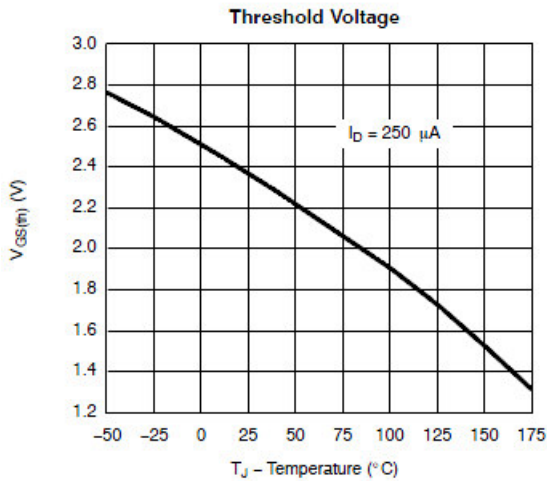
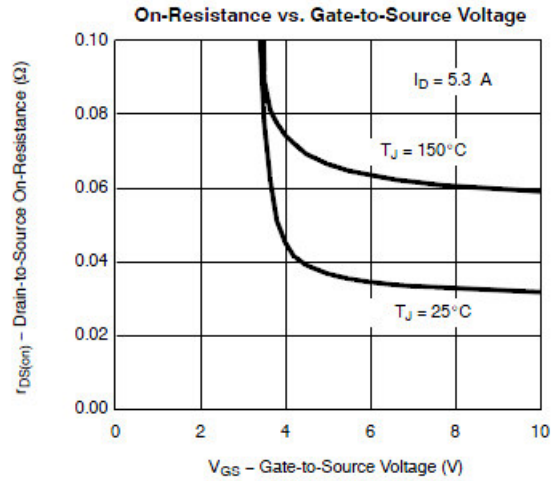
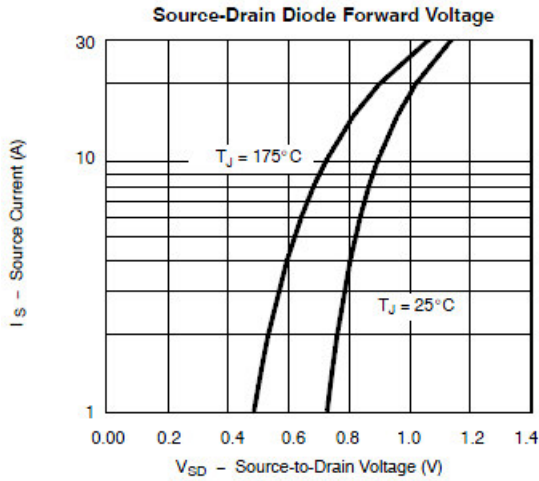



Typical Characteristics

Gate Charge Test Circuit & Waveform



Resistive Switching Test Circuit & Waveforms



Unclamped Inductive Switching Test Circuit & Waveforms





Package Information (SOT-223)

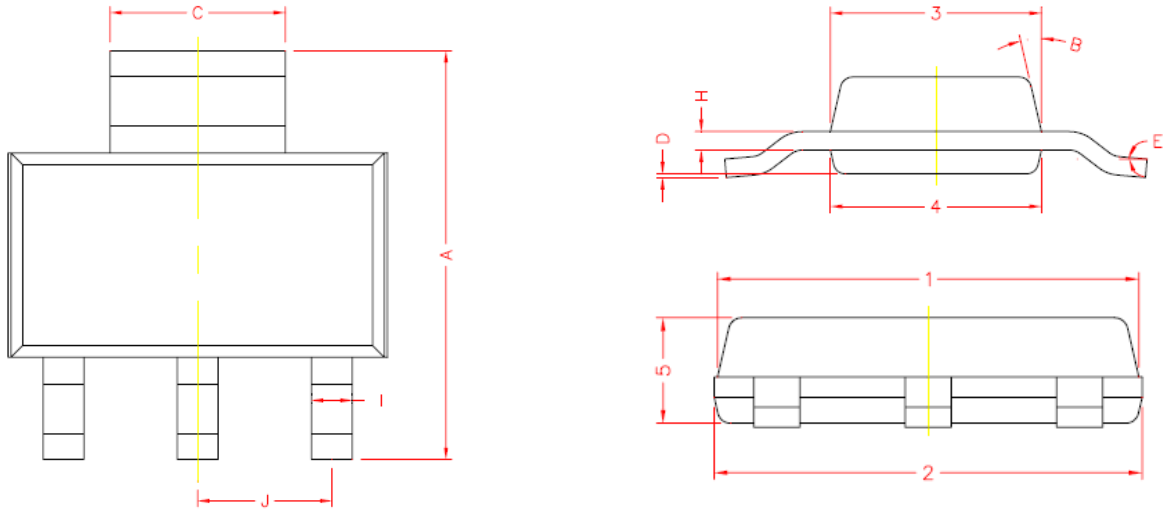

REF.	DIMENSIONS	
	Millimeters	
	Min.	Max.
A	6.70	7.30
C	2.90	3.10
D	0.02	0.10
E	0*	10*
I	0.60	0.80
H	0.25	0.35
B	13° TYP.	
J	2.30 REF.	
1	6.30	6.70
2	6.30	6.70
3	3.30	3.70
4	3.30	3.70
5	1.40	1.80

©2010 Alfa-MOS Technology Corp.
 2F, No.80, Sec.1, Cheng Kung Rd., Nan Kang Dist., Taipei City 115, Taiwan (R.O.C.)
 Tel : 886 2) 2651 3928
 Fax : 886 2) 2786 8483
 ©http://www.alfa-mos.com