



General Description

AFN4997, N-Channel enhancement mode MOSFET, uses Advanced Trench Technology to provide excellent $R_{DS(ON)}$, low gate charge.

These devices are particularly suited for low voltage power management, and low in-line power loss are needed in commercial industrial surface mount applications.

Features

- 90V/6.8A, $R_{DS(ON)}=68m\Omega@V_{GS}=10V$
- 90V/5.6A, $R_{DS(ON)}=75m\Omega@V_{GS}=4.5V$
- Super high density cell design for extremely low $R_{DS(ON)}$
- SOP-8P package design

Pin Description (SOP-8P)

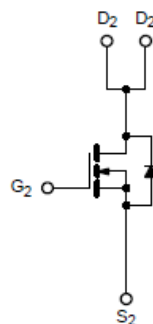
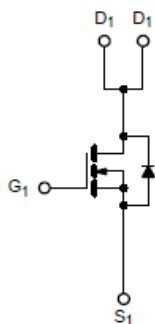
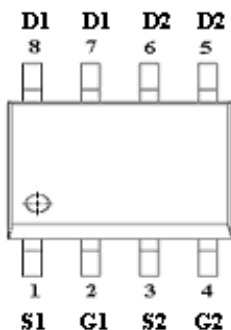

Application

- Motor and Load Control
- AD/DC Inverter Systems.
- Power Management in White LED System

Pin Define

| Pin | Symbol | Description |
|-----|--------|-------------|
| 1 | S1 | Source 1 |
| 2 | G1 | Gate 1 |
| 3 | S2 | Source 2 |
| 4 | G2 | Gate 2 |
| 5 | D2 | Drain 2 |
| 6 | D2 | Drain 2 |
| 7 | D1 | Drain 1 |
| 8 | D1 | Drain 1 |

Ordering Information

| Part Ordering No. | Part Marking | Package | Unit | Quantity |
|-------------------|--------------|---------|-------------|----------|
| AFN4997S8RG | 4997 | SOP-8P | Tape & Reel | 3000 EA |

※ A Lot code

※ B Date code

※ AFN4997S8RG : 13" Tape & Reel ; Pb- Free ; Halogen- Free



Absolute Maximum Ratings

(T_A=25°C Unless otherwise noted)

| Parameter | Symbol | Typical | Unit |
|---|------------------|----------------------|------|
| Drain-Source Voltage | V _{DSS} | 90 | V |
| Gate –Source Voltage | V _{GSS} | ±20 | V |
| Continuous Drain Current(T _J =150°C) | I _D | T _A =25°C | 6.8 |
| | | T _A =70°C | 5.6 |
| Pulsed Drain Current | I _{DM} | 30 | A |
| Continuous Source Current(Diode Conduction) | I _S | 1.5 | A |
| Power Dissipation | P _D | T _A =25°C | 2.8 |
| | | T _A =70°C | 1.8 |
| Operating Junction Temperature | T _J | 150 | °C |
| Storage Temperature Range | T _{STG} | -55/150 | °C |
| Thermal Resistance-Junction to Ambient | R _{θJA} | 62.5 | °C/W |

Electrical Characteristics

(T_A=25°C Unless otherwise noted)

| Parameter | Symbol | Conditions | Min. | Typ | Max. | Unit |
|---------------------------------|----------------------|--|------|-----|------|------|
| Static | | | | | | |
| Drain-Source Breakdown Voltage | V _{(BR)DSS} | V _{GS} =0V, I _D =250uA | 90 | | | V |
| Gate Threshold Voltage | V _{GS(th)} | V _{DS} =V _{GS} , I _D =250uA | 1.0 | | 2.5 | V |
| Gate Leakage Current | I _{GSS} | V _{DS} =0V, V _{GS} =±20V | | | ±100 | nA |
| Zero Gate Voltage Drain Current | I _{DSS} | V _{DS} =80V, V _{GS} =0V | | | 1 | uA |
| | | V _{DS} =90V, V _{GS} =0V T _J =85°C | | | 5 | |
| On-State Drain Current | I _{D(on)} | V _{DS} ≥ 5V, V _{GS} =4.5V | 30 | | | A |
| Drain-Source On-Resistance | R _{DS(on)} | V _{GS} =10V, I _D =6.8A | | 53 | 68 | mΩ |
| | | V _{GS} =4.5V, I _D =5.6A | | 60 | 75 | |
| Forward Transconductance | g _{FS} | V _{DS} =15V, I _D =5.3A | | 24 | | S |
| Diode Forward Voltage | V _{SD} | I _S =2.0A, V _{GS} =0V | | 0.8 | 1.2 | V |
| Dynamic | | | | | | |
| Total Gate Charge | Q _g | V _{DS} =50V, V _{GS} =5V I _D ≅5A | | 10 | 15 | nC |
| Gate-Source Charge | Q _{gs} | | | 4.0 | | |
| Gate-Drain Charge | Q _{gd} | | | 5.0 | | |
| Input Capacitance | C _{iss} | V _{DS} =50V, V _{GS} =0V f=1MHz | | 550 | | pF |
| Output Capacitance | C _{oss} | | | 80 | | |
| Reverse Transfer Capacitance | C _{rss} | | | 50 | | |
| Turn-On Time | t _{d(on)} | V _{DD} =50V, R _L =12.5Ω I _D ≅5.0A, V _{GEN} =10V R _G =1.0Ω | | 10 | 20 | ns |
| | t _r | | | 10 | 20 | |
| Turn-Off Time | t _{d(off)} | | | 15 | 25 | |
| | t _f | | | 10 | 25 | |



Typical Characteristics

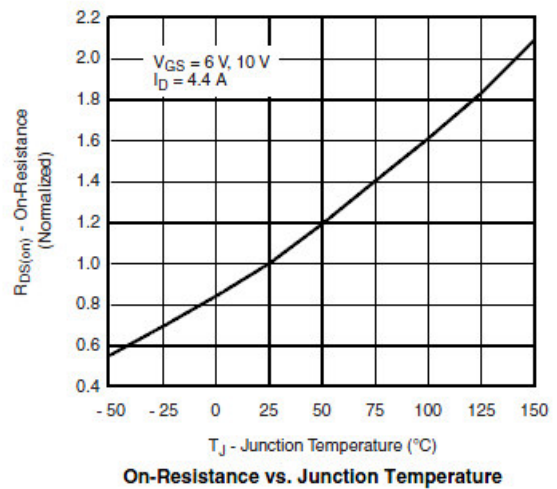
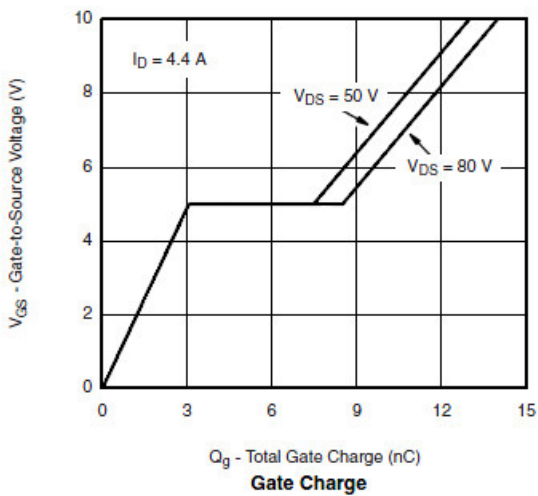
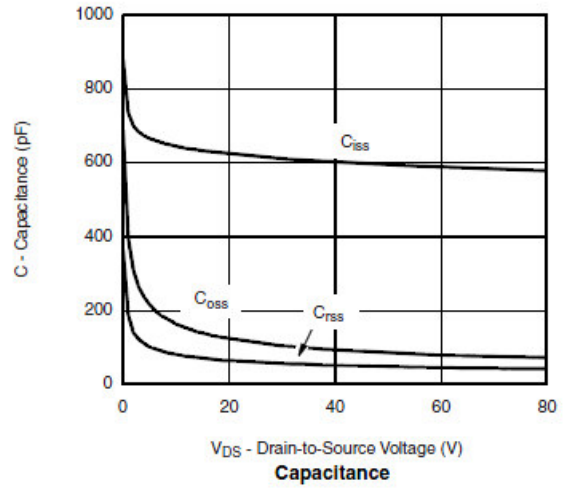
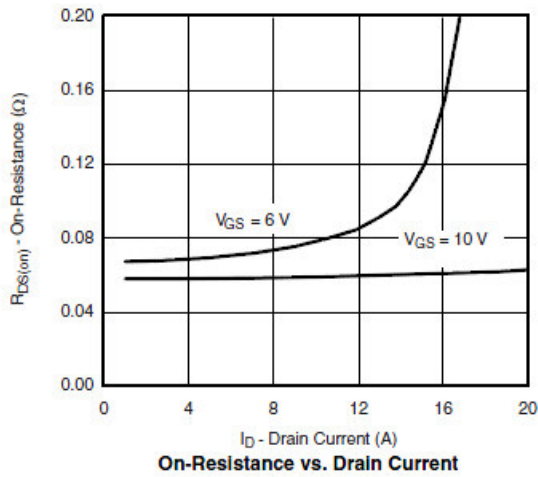
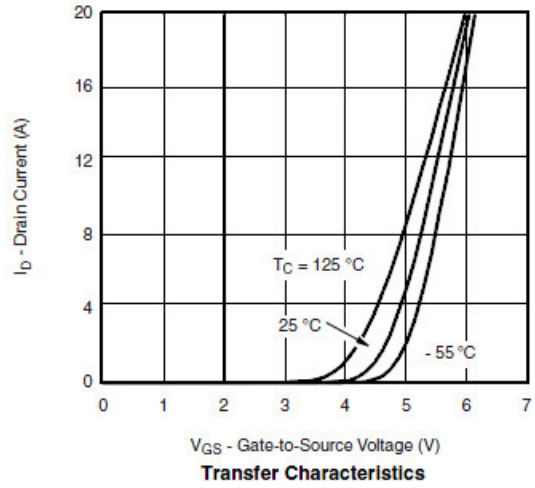
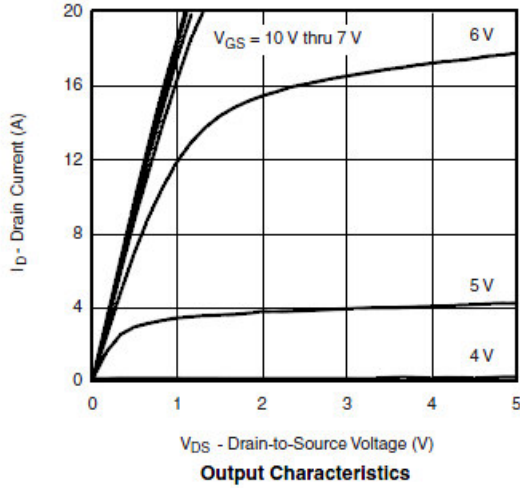



Typical Characteristics

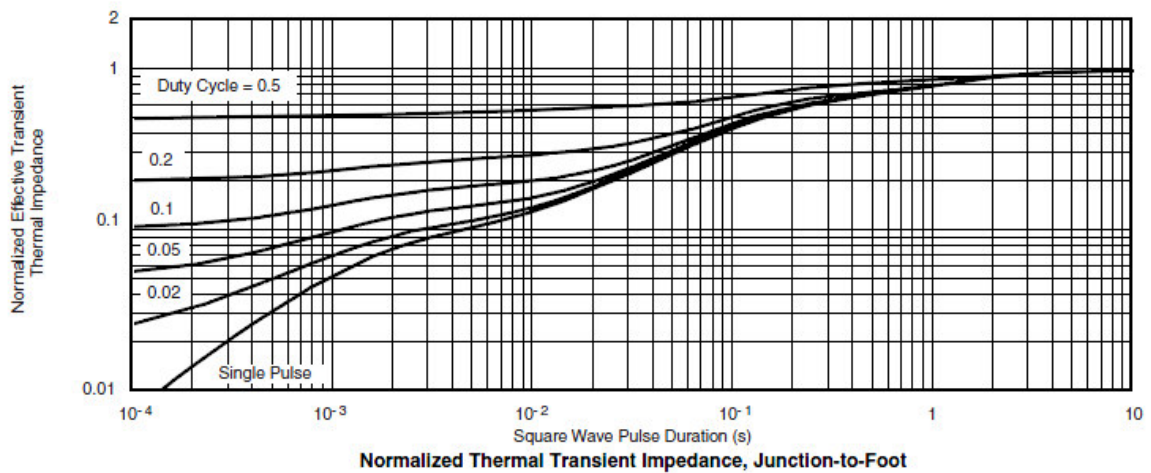
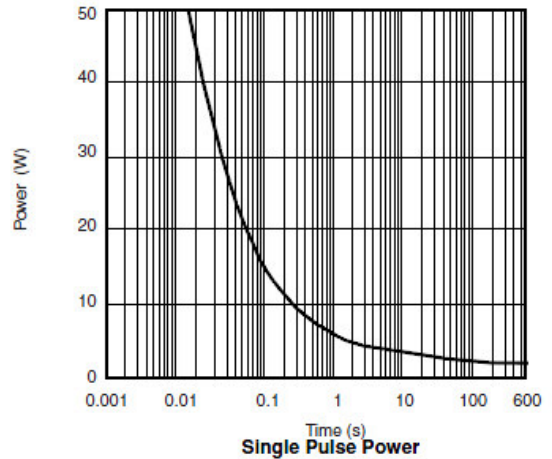
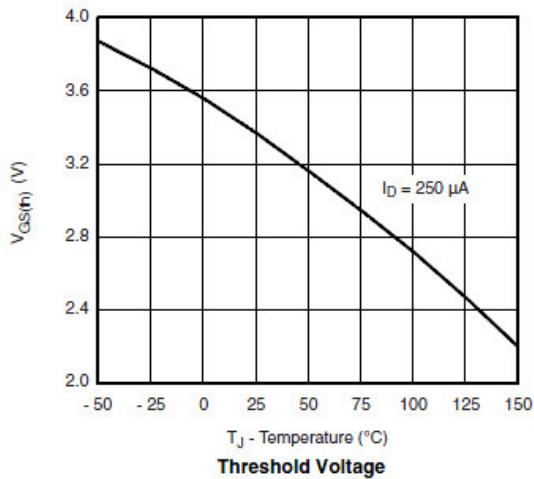
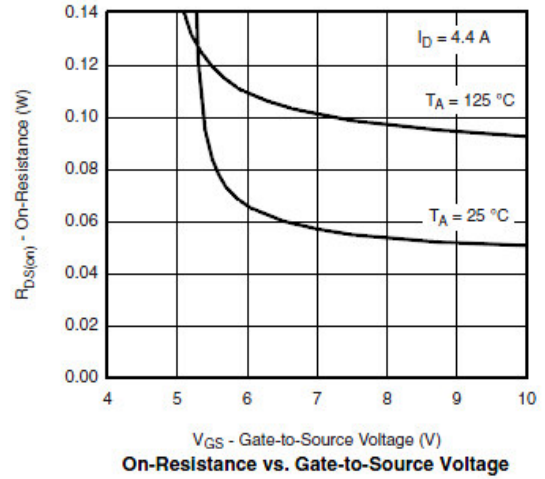
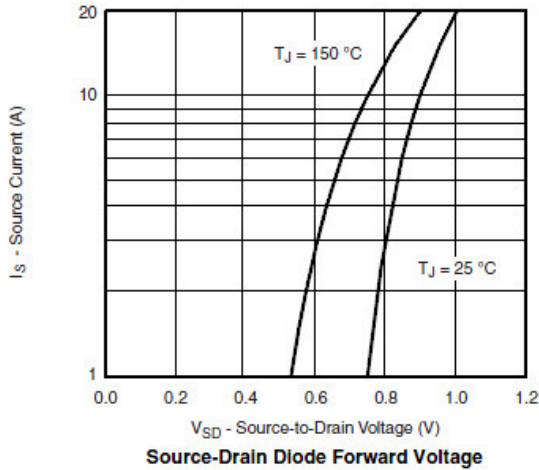



Typical Characteristics

Gate Charge Test Circuit & Waveform



Resistive Switching Test Circuit & Waveforms



Unclamped Inductive Switching Test Circuit & Waveforms





Package Information (SOP-8P)

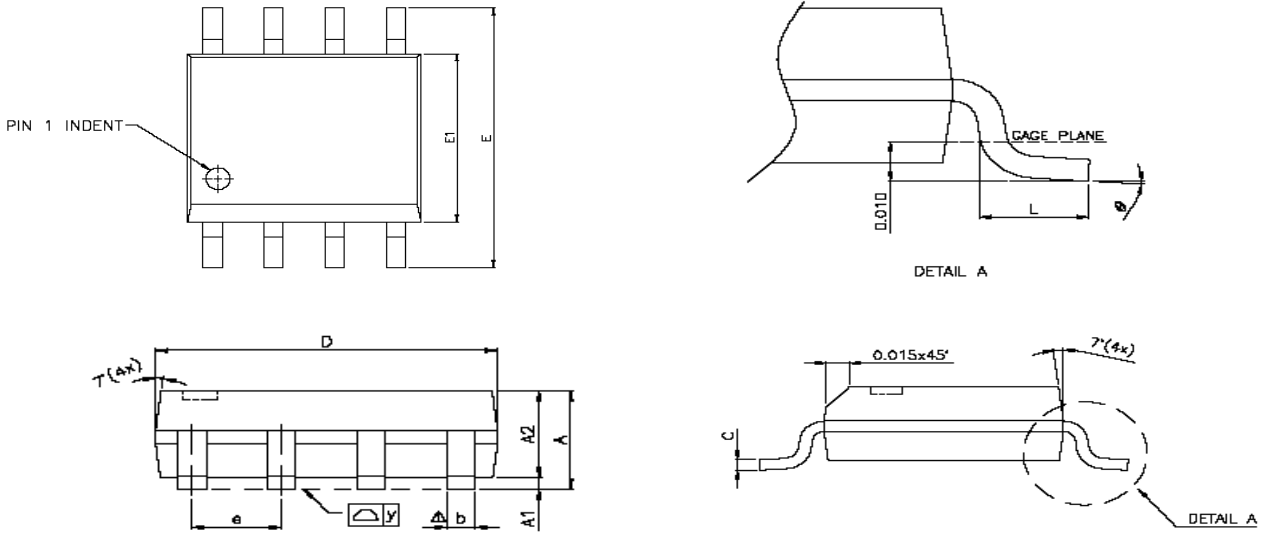

| SYMBOLS | DIMENSIONS IN MILLIMETERS | | | DIMENSIONS IN INCHES | | |
|---------------|---------------------------|------|-------|----------------------|-------|--------|
| | MIN | NOM | MAX | MIN | NOM | MAX |
| A | 1.47 | 1.60 | 1.73 | 0.058 | 0.063 | 0.068 |
| A1 | 0.10 | — | 0.25 | 0.004 | — | 0.010 |
| A2 | — | 1.45 | — | — | 0.057 | — |
| b | 0.33 | 0.41 | 0.51 | 0.013 | 0.016 | 0.020 |
| C | 0.19 | 0.20 | 0.25 | 0.0075 | 0.008 | 0.0098 |
| D | 4.80 | 4.85 | 4.95 | 0.189 | 0.191 | 0.195 |
| E | 5.80 | 6.00 | 6.20 | 0.228 | 0.236 | 0.244 |
| E1 | 3.80 | 3.90 | 4.00 | 0.150 | 0.154 | 0.157 |
| e | — | 1.27 | — | — | 0.050 | — |
| L | 0.38 | 0.71 | 1.27 | 0.015 | 0.028 | 0.050 |
| Δy | — | — | 0.076 | — | — | 0.003 |
| \varnothing | 0° | — | 8° | 0° | — | 8° |

©2010 Alfa-MOS Technology Corp.
 2F, No.80, Sec.1, Cheng Kung Rd., Nan Kang Dist., Taipei City 115, Taiwan (R.O.C.)
 Tel : 886 2) 2651 3928
 Fax : 886 2) 2786 8483
 ©http://www.alfa-mos.com