



General Description

AFN4808W, N-Channel enhancement mode MOSFET, uses Advanced Trench Technology to provide excellent $R_{DS(ON)}$, low gate charge.

These devices are particularly suited for low voltage power management, such as smart phone and notebook computer and other battery powered circuits, and low in-line power loss are needed in commercial industrial surface mount applications.

Features

- 20V/6.2A, $R_{DS(ON)}=30m\Omega@V_{GS}=4.5V$
- 20V/4.6A, $R_{DS(ON)}=35m\Omega@V_{GS}=2.5V$
- 20V/3.8A, $R_{DS(ON)}=42m\Omega@V_{GS}=1.8V$
- Super high density cell design for extremely low $R_{DS(ON)}$
- Exceptional on-resistance and maximum DC current capability
- DFN2X3-8L package design

Pin Description (DFN2X3-8L)

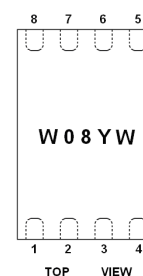
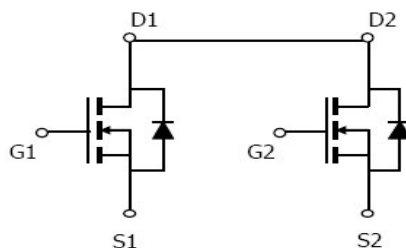
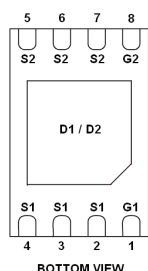

Application

- Load Switch
- Portable Equipment
- Battery Powered System

Pin Define

Pin	Symbol	Description
1	G1	Gate1
2	S1	Source1
3	S1	Source1
4	S1	Source1
5	S2	Source2
6	S2	Source2
7	S2	Source2
8	G2	Gate2

Ordering Information

Part Ordering No.	Part Marking	Package	Unit	Quantity
AFN4808WFN238RG	W08YW	DFN2X3-8L	Tape & Reel	3000 EA

- ※ W08 parts code
- ※ Y year code
- ※ W week code (A ~ Z = 1 ~ 26 / a ~ z = 27 ~ 52)
- ※ AFN4808WFN238RG : 7" Tape & Reel ; Pb- Free ; Halogen- Free



Absolute Maximum Ratings

(T_A=25°C Unless otherwise noted)

Parameter	Symbol	Typical	Unit
Drain-Source Voltage	V _{DSS}	20	V
Gate –Source Voltage	V _{GSS}	±12	V
Continuous Drain Current(T _J =150°C)	I _D	T _A =25°C	6.2
		T _A =70°C	3.8
Pulsed Drain Current	I _{DM}	40	A
Continuous Source Current(Diode Conduction)	I _S	1.6	A
Power Dissipation	P _D	T _A =25°C	1.56
		T _A =70°C	1.0
Operating Junction Temperature	T _J	150	°C
Storage Temperature Range	T _{STG}	-55/150	°C
Thermal Resistance-Junction to Ambient	R _{θJA}	120	°C/W

Electrical Characteristics

(T_A=25°C Unless otherwise noted)

Parameter	Symbol	Conditions	Min.	Typ	Max.	Unit
Static						
Drain-Source Breakdown Voltage	V _{(BR)DSS}	V _{GS} =0V, I _D =250uA	20			V
Gate Threshold Voltage	V _{GS(th)}	V _{DS} =V _{GS} , I _D =250uA	0.3		0.8	
Gate Leakage Current	I _{GSS}	V _{DS} =0V, V _{GS} =±12V			±100	nA
Zero Gate Voltage Drain Current	I _{DSS}	V _{DS} =16V, V _{GS} =0V			1	uA
		V _{DS} =16V, V _{GS} =0V T _J =85°C			10	
On-State Drain Current	I _{D(on)}	V _{DS} ≥ 5V, V _{GS} =4.5V	6			A
		V _{DS} ≥ 5V, V _{GS} =2.5V	4			
Drain-Source On-Resistance	R _{DS(on)}	V _{GS} =4.5V, I _D =6.2A		22	30	mΩ
		V _{GS} =2.5V, I _D =4.6A		25	35	
		V _{GS} =1.8V, I _D =3.8A		30	42	
Forward Transconductance	g _{FS}	V _{DS} =5V, I _D =3.6A		10		S
Diode Forward Voltage	V _{SD}	I _S =1.6A, V _{GS} =0V		0.85	1.2	V
Dynamic						
Total Gate Charge	Q _g	V _{DS} =10V, V _{GS} =4.5V I _D ≧6.2A		6.2	10	nC
Gate-Source Charge	Q _{gs}			1.0		
Gate-Drain Charge	Q _{gd}			1.6		
Input Capacitance	C _{iss}	V _{DS} =10V, V _{GS} =0V f=1MHz		480		pF
Output Capacitance	C _{oss}			160		
Reverse Transfer Capacitance	C _{rss}			100		
Turn-On Time	t _{d(on)}	V _{DD} =10V, R _L =1.9Ω I _D ≧5.4A, V _{GEN} =4.5V R _G =1Ω		10	16	ns
	t _r			12	25	
Turn-Off Time	t _{d(off)}			25	40	
	t _f			12	20	



Typical Characteristics

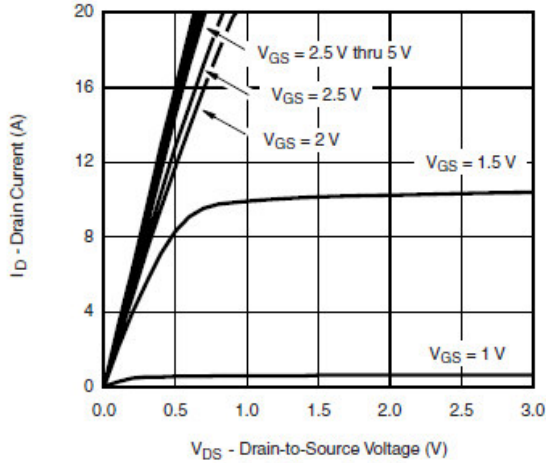

Output Characteristics

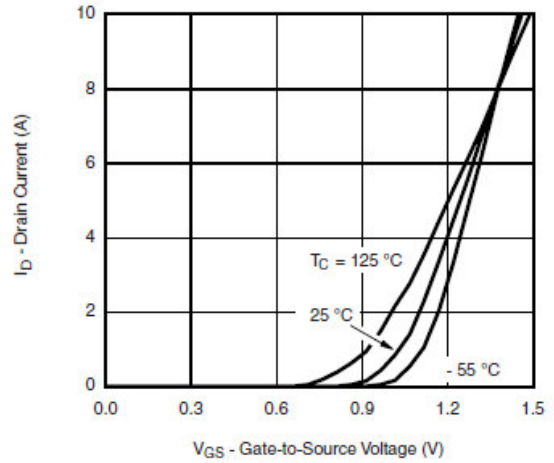

Transfer Characteristics

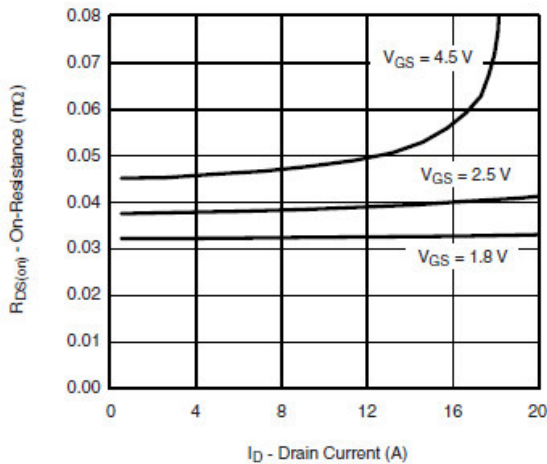

On-Resistance vs. Drain Current and Gate Voltage

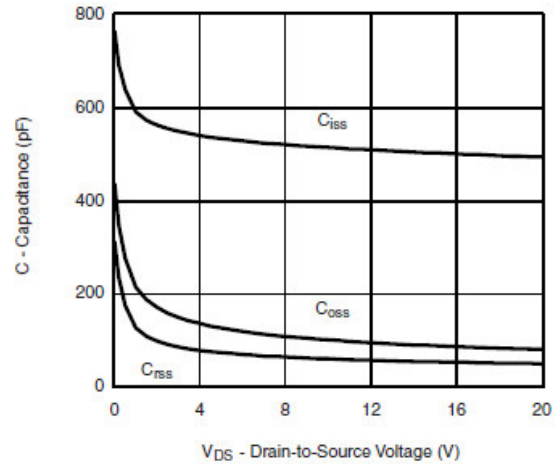

Capacitance

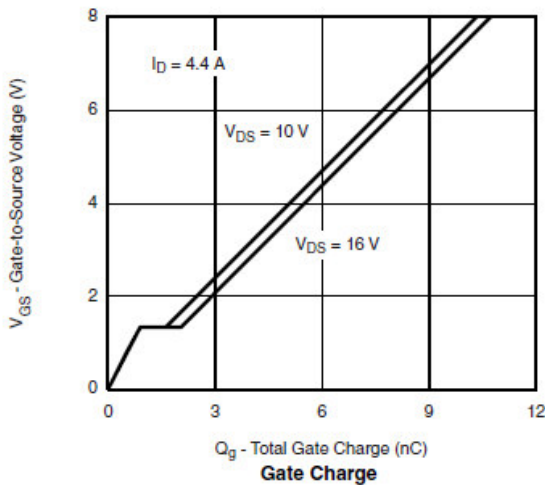

Gate Charge

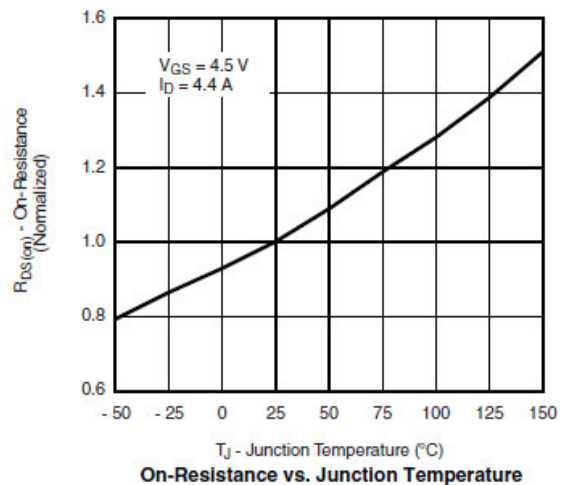

On-Resistance vs. Junction Temperature



Typical Characteristics

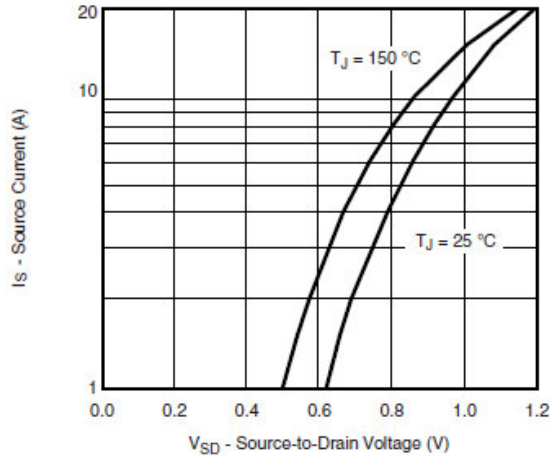

Source-Drain Diode Forward Voltage

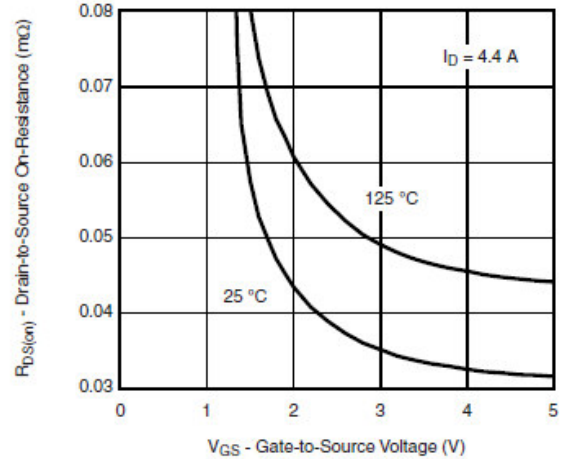

On-Resistance vs. Gate-to-Source Voltage

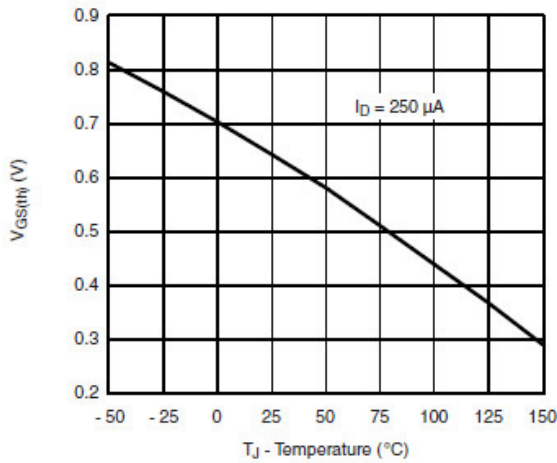

Threshold Voltage

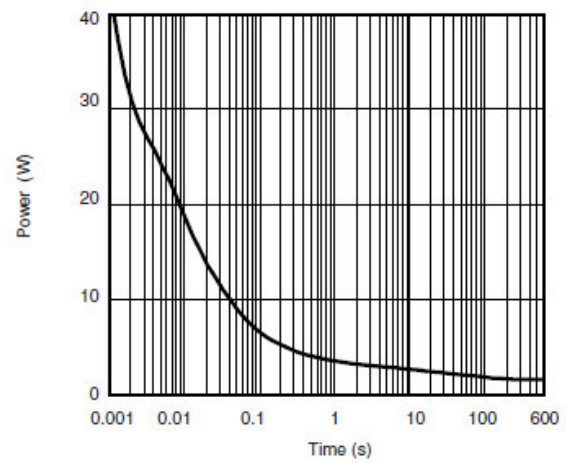

Single Pulse Power, Junction-to-Ambient

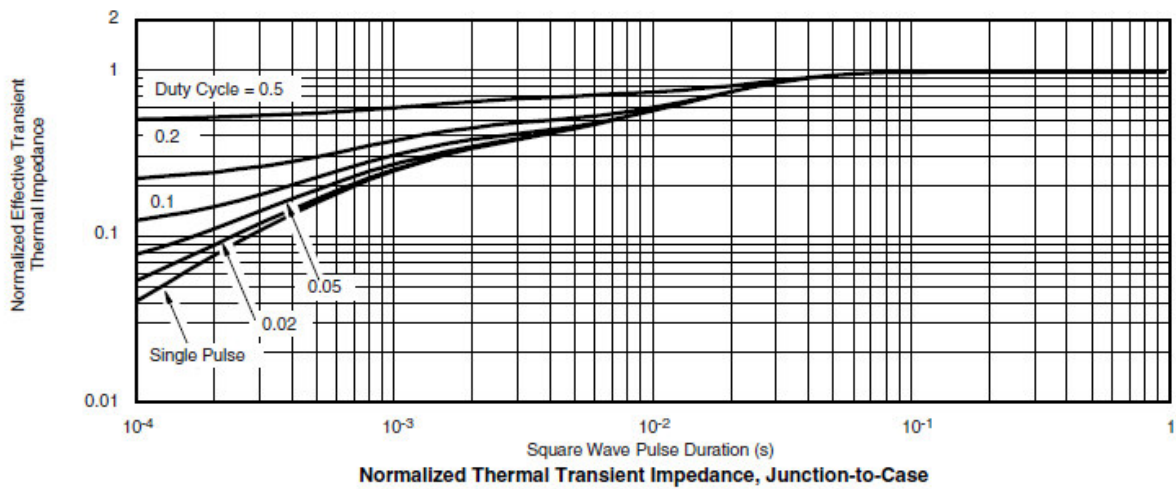

Normalized Thermal Transient Impedance, Junction-to-Case



Typical Characteristics

Gate Charge Test Circuit & Waveform



Resistive Switching Test Circuit & Waveforms



Unclamped Inductive Switching Test Circuit & Waveforms





Package Information (DFN2X3-8L)

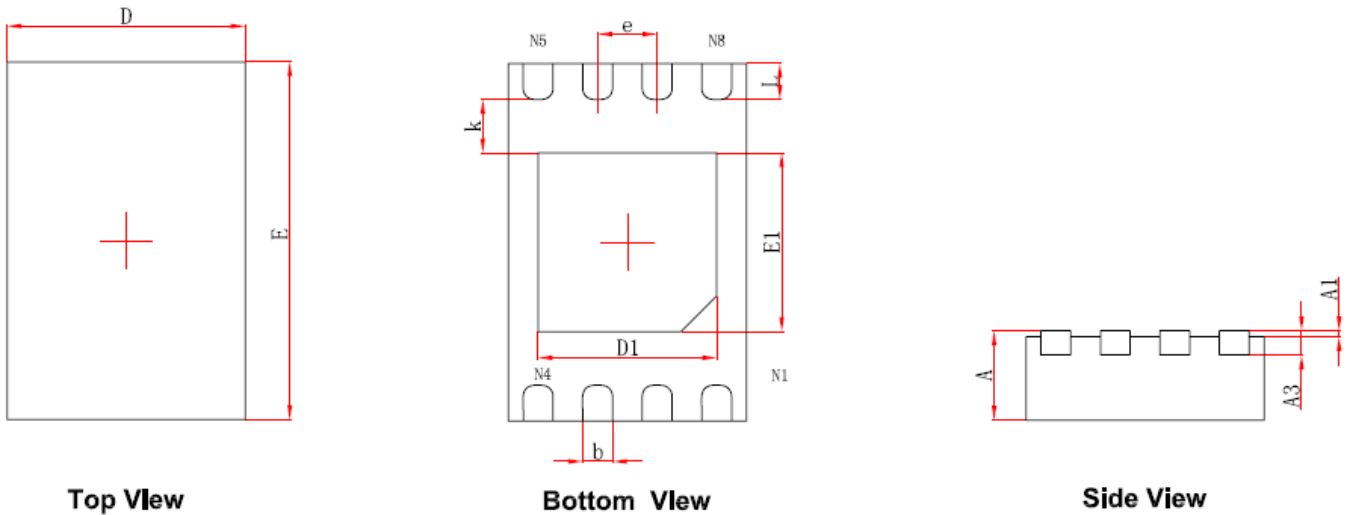

Symbol	Dimensions In Millimeters		Dimensions In Inches	
	Min.	Max.	Min.	Max.
A	0.700	0.800	0.028	0.031
A1	0.000	0.050	0.000	0.002
A3	0.203REF.		0.008REF.	
D	1.924	2.076	0.076	0.082
E	2.924	3.076	0.115	0.121
D1	1.400	1.600	0.055	0.063
E1	1.400	1.600	0.055	0.063
k	0.200MIN.		0.008MIN.	
b	0.200	0.300	0.008	0.012
e	0.500TYP.		0.020TYP.	
L	0.224	0.376	0.009	0.015

©2010 Alfa-MOS Technology Corp.
 2F, No.80, Sec.1, Cheng Kung Rd., Nan Kang Dist., Taipei City 115, Taiwan (R.O.C.)
 Tel : 886 2) 2651 3928
 Fax : 886 2) 2786 8483
 ©http://www.alfa-mos.com