



### General Description

AFN4634WS, N-Channel enhancement mode MOSFET, uses Advanced Trench Technology to provide excellent  $R_{DS(ON)}$ , low gate charge.

These devices are particularly suited for low voltage power management, and low in-line power loss are needed in commercial industrial surface mount applications.

### Features

- 30V/18A,  $R_{DS(ON)}=5.8m\Omega@V_{GS}=10V$
- 30V/15A,  $R_{DS(ON)}=7.2m\Omega@V_{GS}=4.5V$
- Super high density cell design for extremely low  $R_{DS(ON)}$
- SOP-8P package design

### Pin Description ( SOP-8P )

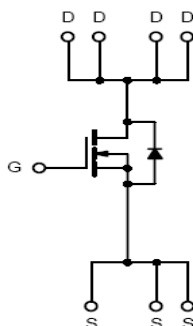
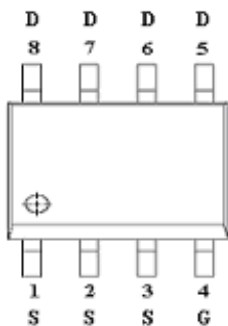

### Application

- Buck Converter
- Synchronous Rectifier  
- Secondary Rectifier
- Notebook

### Pin Define

Pin	Symbol	Description
1	S	Source
2	S	Source
3	S	Source
4	G	Gate
5	D	Drain
6	D	Drain
7	D	Drain
8	D	Drain

### Ordering Information

Part Ordering No.	Part Marking	Package	Unit	Quantity
AFN4634WSS8RG	4634WS	SOP-8P	Tape & Reel	2500 EA

- ※ A Lot code
- ※ B Date code
- ※ AFN4634WSS8RG : 13" Tape & Reel ; Pb- Free ; Halogen- Free



**Absolute Maximum Ratings**

(T<sub>A</sub>=25°C Unless otherwise noted)

Parameter	Symbol	Typical	Unit
Drain-Source Voltage	V <sub>DSS</sub>	30	V
Gate –Source Voltage	V <sub>GSS</sub>	±20	V
Continuous Drain Current(T <sub>J</sub> =150°C)	I <sub>D</sub>	T <sub>A</sub> =25°C	18
		T <sub>A</sub> =70°C	15
Pulsed Drain Current	I <sub>DM</sub>	50	A
Continuous Source Current(Diode Conduction)	I <sub>S</sub>	3.8	A
Power Dissipation	P <sub>D</sub>	T <sub>A</sub> =25°C	2.8
		T <sub>A</sub> =70°C	1.8
Operating Junction Temperature	T <sub>J</sub>	150	°C
Storage Temperature Range	T <sub>STG</sub>	-55/150	°C
Thermal Resistance-Junction to Ambient	R <sub>θJA</sub>	62.5	°C/W

**Electrical Characteristics**

(T<sub>A</sub>=25°C Unless otherwise noted)

Parameter	Symbol	Conditions	Min.	Typ	Max.	Unit
<b>Static</b>						
Drain-Source Breakdown Voltage	V <sub>(BR)DSS</sub>	V <sub>GS</sub> =0V, I <sub>D</sub> =250uA	30			V
Gate Threshold Voltage	V <sub>GS(th)</sub>	V <sub>DS</sub> =V <sub>GS</sub> , I <sub>D</sub> =250uA	1.0		2.0	V
Gate Leakage Current	I <sub>GSS</sub>	V <sub>DS</sub> =0V, V <sub>GS</sub> =±20V			±100	nA
Zero Gate Voltage Drain Current	I <sub>DSS</sub>	V <sub>DS</sub> =24V, V <sub>GS</sub> =0V			1	uA
		V <sub>DS</sub> =24V, V <sub>GS</sub> =0V T <sub>J</sub> =85°C			10	
On-State Drain Current	I <sub>D(on)</sub>	V <sub>DS</sub> ≥ 5V, V <sub>GS</sub> =10V	15			A
Drain-Source On-Resistance	R <sub>DS(on)</sub>	V <sub>GS</sub> =10V, I <sub>D</sub> =18A		4.8	5.8	mΩ
		V <sub>GS</sub> =4.5V, I <sub>D</sub> =15A		6.0	7.2	
Forward Transconductance	g <sub>FS</sub>	V <sub>DS</sub> =15V, I <sub>D</sub> =10A		24		S
Diode Forward Voltage	V <sub>SD</sub>	I <sub>S</sub> =10A, V <sub>GS</sub> =0V		0.8	1.3	V
<b>Dynamic</b>						
Total Gate Charge	Q <sub>g</sub>	V <sub>DS</sub> =15V, V <sub>GS</sub> =4.5V I <sub>D</sub> ≡10A		22	42	nC
Gate-Source Charge	Q <sub>gs</sub>			8		
Gate-Drain Charge	Q <sub>gd</sub>			7		
Input Capacitance	C <sub>iss</sub>	V <sub>DS</sub> =15V, V <sub>GS</sub> =0V f=1MHz		2800		pF
Output Capacitance	C <sub>oss</sub>			480		
Reverse Transfer Capacitance	C <sub>rss</sub>			300		
Turn-On Time	t <sub>d(on)</sub>	V <sub>DD</sub> =15V, R <sub>L</sub> =1.5Ω I <sub>D</sub> ≡10A, V <sub>GEN</sub> =10V R <sub>G</sub> =1.0Ω		15	30	ns
	t <sub>r</sub>			12	20	
Turn-Off Time	t <sub>d(off)</sub>			30	50	
	t <sub>f</sub>			10	20	



## Typical Characteristics

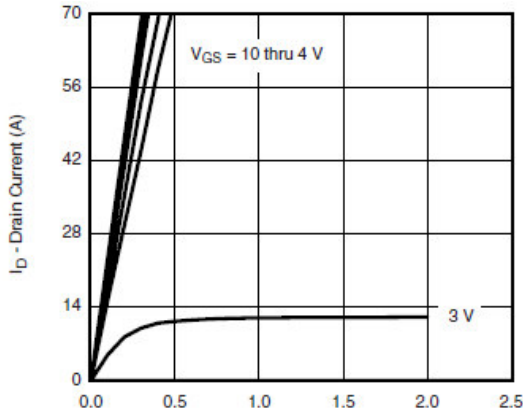

Output Characteristics

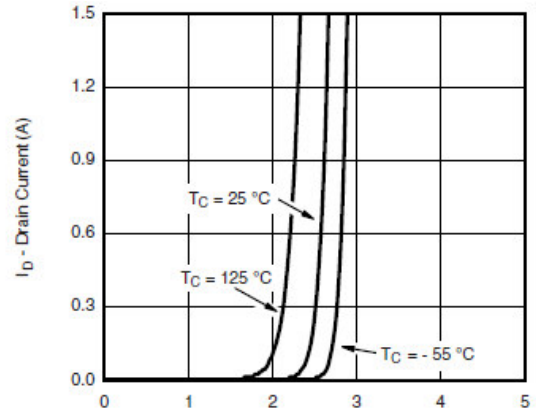

Transfer Characteristics

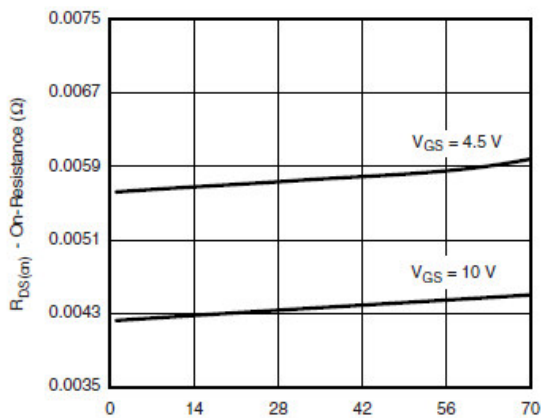

On-Resistance vs. Drain Current and Gate Voltage

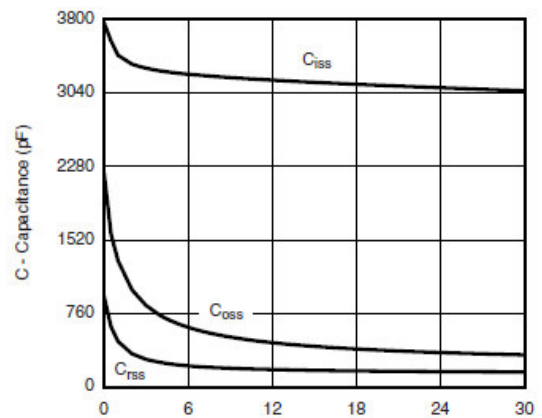

Capacitance

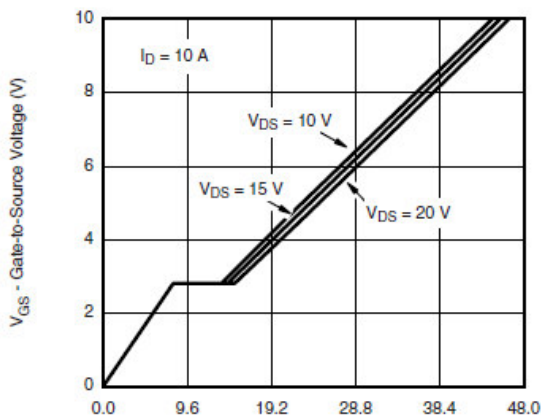

Gate Charge

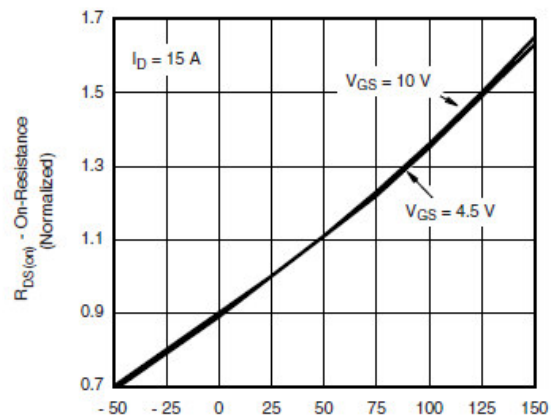

On-Resistance vs. Junction Temperature



## Typical Characteristics

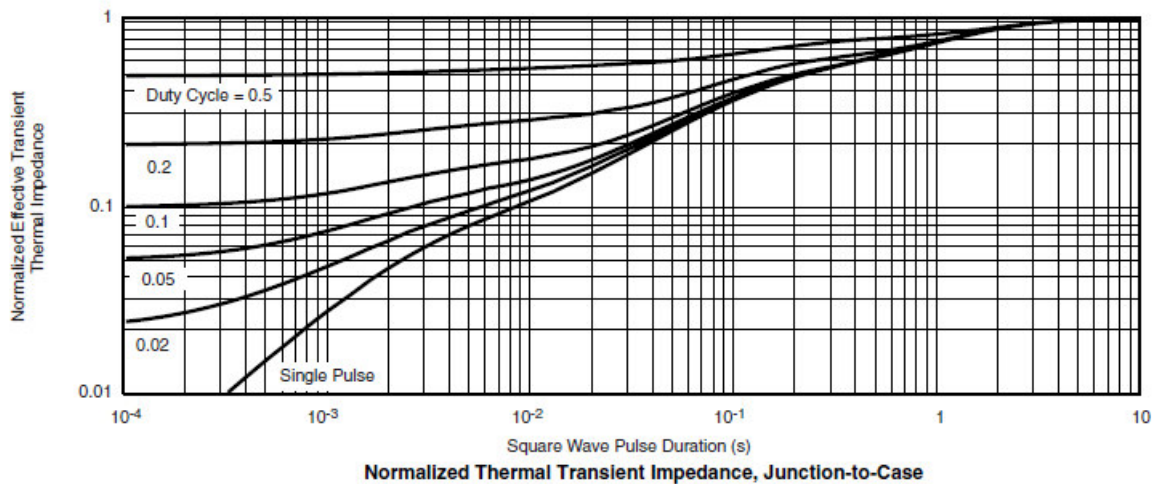
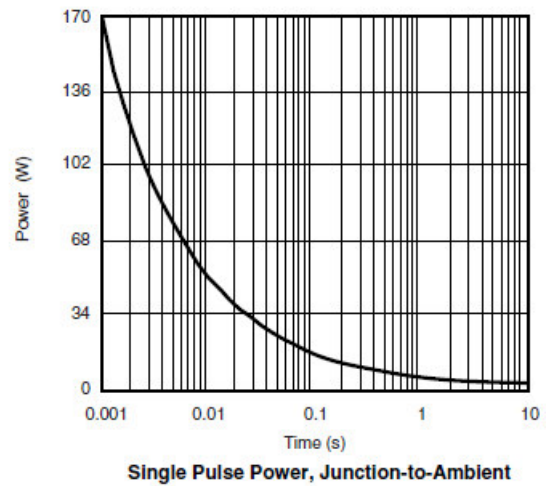
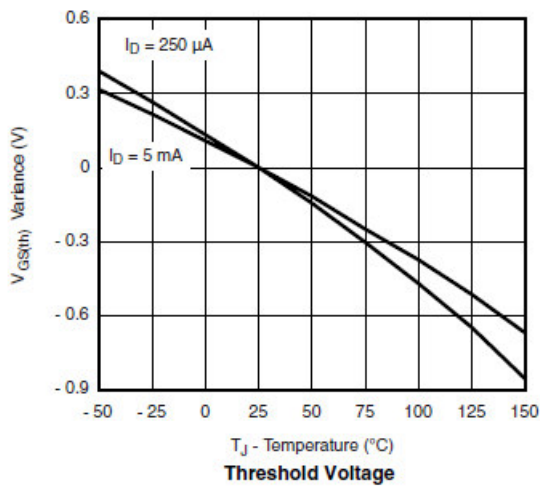
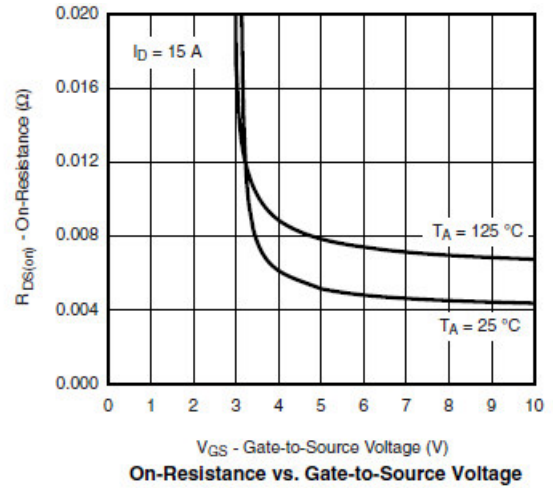
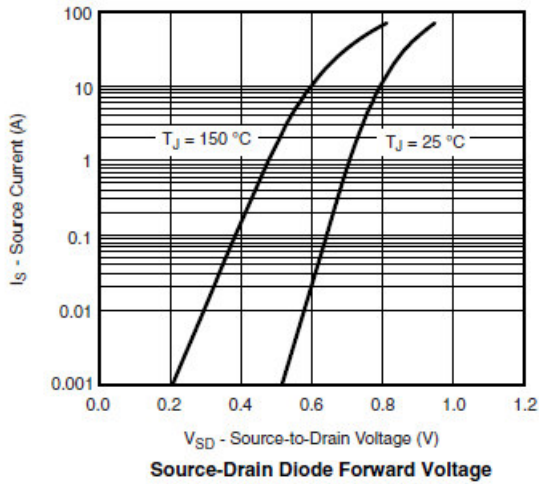



**Typical Characteristics**

Gate Charge Test Circuit & Waveform



Resistive Switching Test Circuit & Waveforms



Unclamped Inductive Switching Test Circuit & Waveforms





**Package Information ( SOP-8P )**

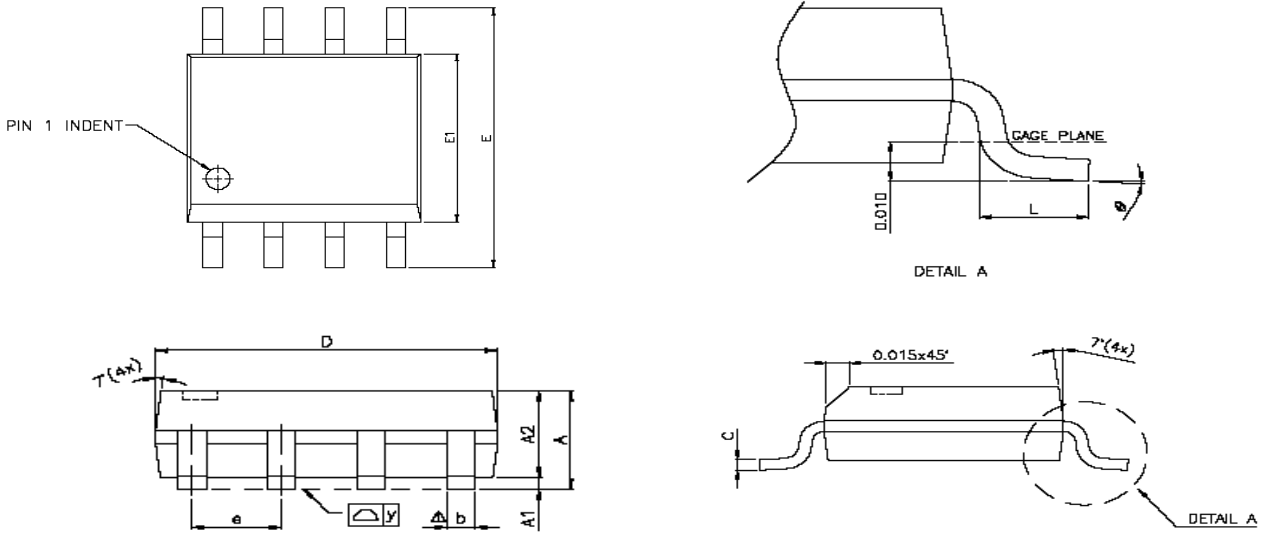

SYMBOLS	DIMENSIONS IN MILLIMETERS			DIMENSIONS IN INCHES		
	MIN	NOM	MAX	MIN	NOM	MAX
A	1.47	1.60	1.73	0.058	0.063	0.068
A1	0.10	—	0.25	0.004	—	0.010
A2	—	1.45	—	—	0.057	—
b	0.33	0.41	0.51	0.013	0.016	0.020
C	0.19	0.20	0.25	0.0075	0.008	0.0098
D	4.80	4.85	4.95	0.189	0.191	0.195
E	5.80	6.00	6.20	0.228	0.236	0.244
E1	3.80	3.90	4.00	0.150	0.154	0.157
e	—	1.27	—	—	0.050	—
L	0.38	0.71	1.27	0.015	0.028	0.050
$\Delta$ y	—	—	0.076	—	—	0.003
$\varnothing$	0°	—	8°	0°	—	8°

©2010 Alfa-MOS Technology Corp.  
 2F, No.80, Sec.1, Cheng Kung Rd., Nan Kang Dist., Taipei City 115, Taiwan (R.O.C.)  
 Tel : 886 2) 2651 3928  
 Fax : 886 2) 2786 8483  
 ©http://www.alfa-mos.com