



General Description

AFN4440, N-Channel enhancement mode MOSFET, uses Advanced Trench Technology to provide excellent $R_{DS(ON)}$, low gate charge.

These devices are particularly suited for low voltage power management, and low in-line power loss are needed in commercial industrial surface mount applications.

Features

- 60V/6.8A, $R_{DS(ON)}=42m\Omega@V_{GS}=10V$
- 60V/5.6A, $R_{DS(ON)}=50m\Omega@V_{GS}=4.5V$
- Super high density cell design for extremely low $R_{DS(ON)}$
- SOP-8P package design

Pin Description (SOP-8P)

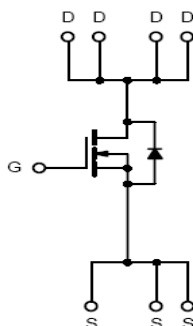
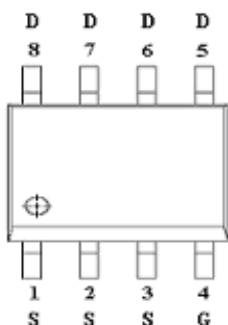

Application

- Motor and Load Control
- Power Management in White LED System
- Push Pull Converter
- LCD TV Inverter & AD/DC Inverter Systems.

Pin Define

Pin	Symbol	Description
1	S	Source
2	S	Source
3	S	Source
4	G	Gate
5	D	Drain
6	D	Drain
7	D	Drain
8	D	Drain

Ordering Information

Part Ordering No.	Part Marking	Package	Unit	Quantity
AFN4440S8RG	4440	SOP-8P	Tape & Reel	3000 EA

- ※ A Lot code
- ※ B Date code
- ※ AFN4440S8RG : 13" Tape & Reel ; Pb- Free ; Halogen- Free



※ Absolute Maximum Ratings

($T_A=25^{\circ}\text{C}$ Unless otherwise noted)

Parameter	Symbol	Typical	Unit
Drain-Source Voltage	V_{DSS}	60	V
Gate –Source Voltage	V_{GSS}	± 20	V
Continuous Drain Current($T_J=150^{\circ}\text{C}$)	I_D	$T_A=25^{\circ}\text{C}$	6.8
		$T_A=70^{\circ}\text{C}$	5.6
Pulsed Drain Current	I_{DM}	30	A
Continuous Source Current(Diode Conduction)	I_S	1.5	A
Power Dissipation	P_D	$T_A=25^{\circ}\text{C}$	2.8
		$T_A=70^{\circ}\text{C}$	1.8
Operating Junction Temperature	T_J	150	$^{\circ}\text{C}$
Storage Temperature Range	T_{STG}	-55/150	$^{\circ}\text{C}$
Thermal Resistance-Junction to Ambient	$R_{\theta JA}$	62.5	$^{\circ}\text{C/W}$

Electrical Characteristics

($T_A=25^{\circ}\text{C}$ Unless otherwise noted)

Parameter	Symbol	Conditions	Min.	Typ	Max.	Unit
Static						
Drain-Source Breakdown Voltage	$V_{(BR)DSS}$	$V_{GS}=0V, I_D=250\mu A$	60			V
Gate Threshold Voltage	$V_{GS(th)}$	$V_{DS}=V_{GS}, I_D=250\mu A$	1.0		2.5	V
Gate Leakage Current	I_{GSS}	$V_{DS}=0V, V_{GS}=\pm 20V$			± 100	nA
Zero Gate Voltage Drain Current	I_{DSS}	$V_{DS}=60V, V_{GS}=0V$			1	uA
		$V_{DS}=60V, V_{GS}=0V$ $T_J=85^{\circ}\text{C}$			5	
On-State Drain Current	$I_{D(on)}$	$V_{DS} \geq 5V, V_{GS}=4.5V$	30			A
Drain-Source On-Resistance	$R_{DS(on)}$	$V_{GS}=10V, I_D=6.8A$		38	42	m Ω
		$V_{GS}=4.5V, I_D=5.6A$		42	50	
Forward Transconductance	g_{FS}	$V_{DS}=15V, I_D=5.3A$		24		S
Diode Forward Voltage	V_{SD}	$I_S=2.0A, V_{GS}=0V$		0.8	1.2	V
Dynamic						
Total Gate Charge	Q_g	$V_{DS}=30V, V_{GS}=5V$ $I_D=5.6A$		10	15	nC
Gate-Source Charge	Q_{gs}			3.5		
Gate-Drain Charge	Q_{gd}			3.6		
Input Capacitance	C_{iss}	$V_{DS}=30V, V_{GS}=0V$ $f=1\text{MHz}$		890		pF
Output Capacitance	C_{oss}			85		
Reverse Transfer Capacitance	C_{rss}			48		
Turn-On Time	$t_{d(on)}$	$V_{DD}=30V, R_L=6.8\Omega$ $I_D=5.0A, V_{GEN}=4.5V$ $R_G=6\Omega$		10	15	ns
	t_r			12	20	
Turn-Off Time	$t_{d(off)}$			25	35	
	t_f			10	15	



Typical Characteristics

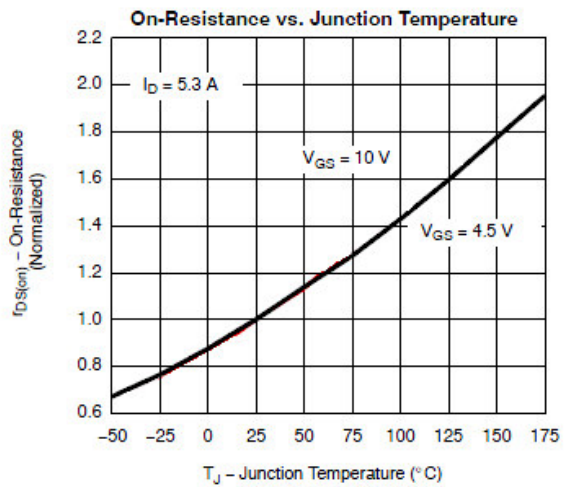
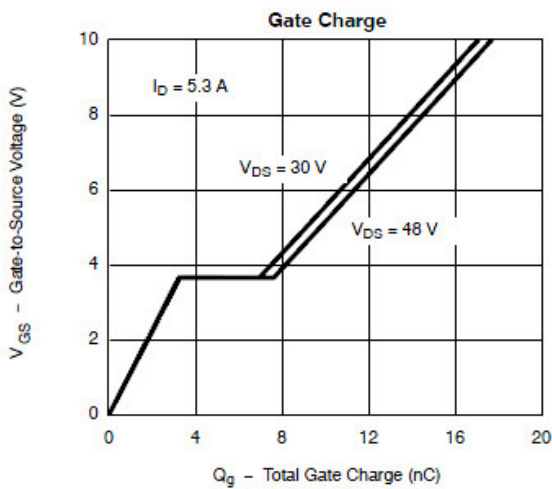
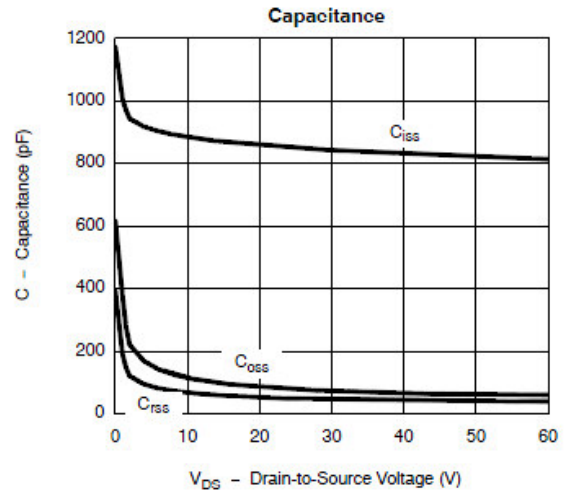
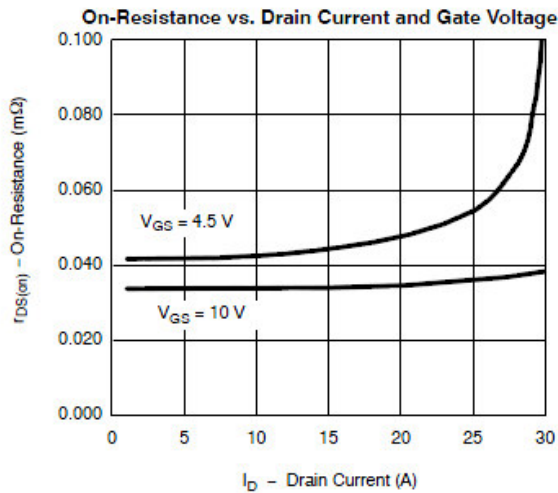
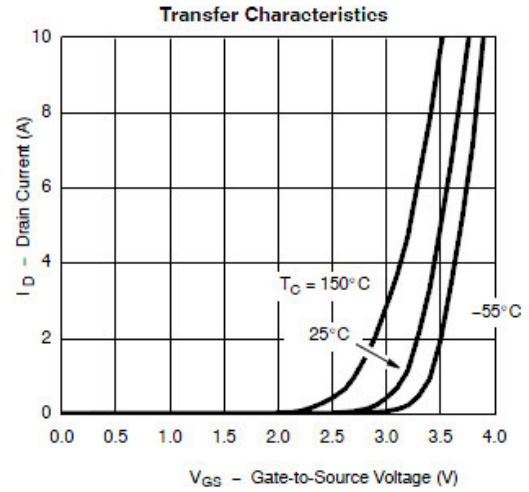
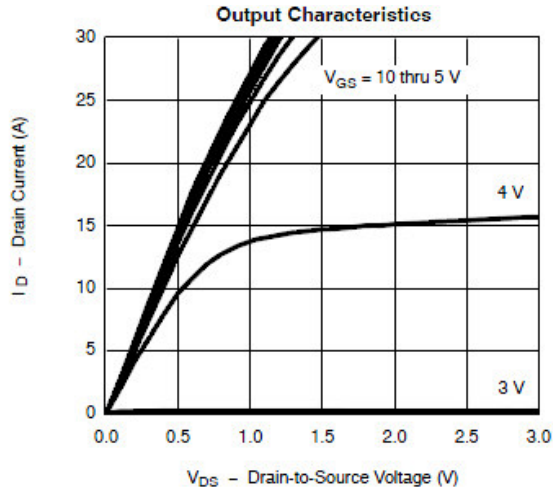



Typical Characteristics

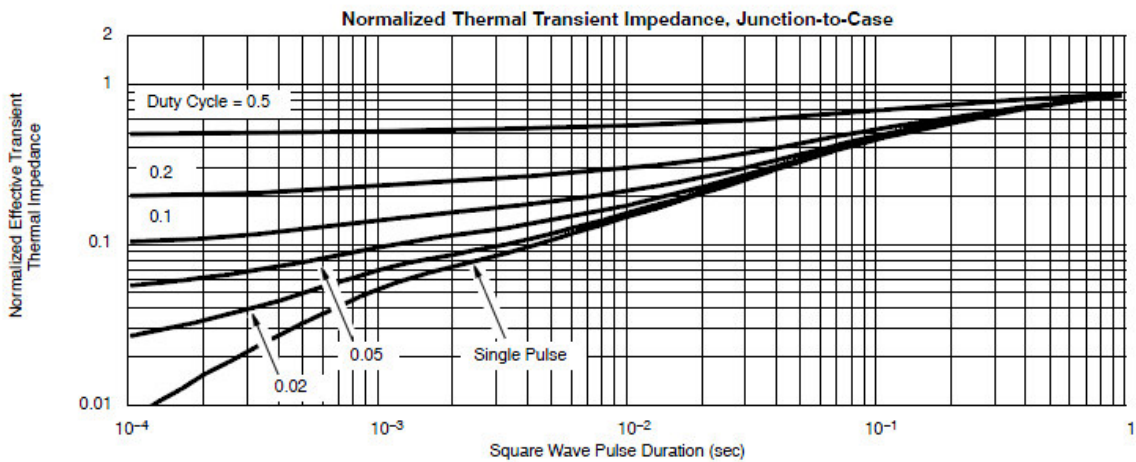
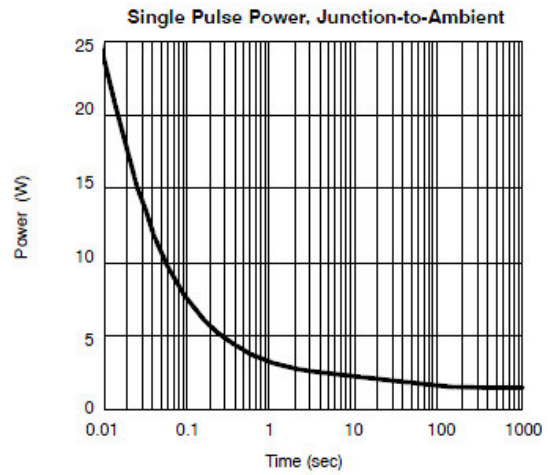
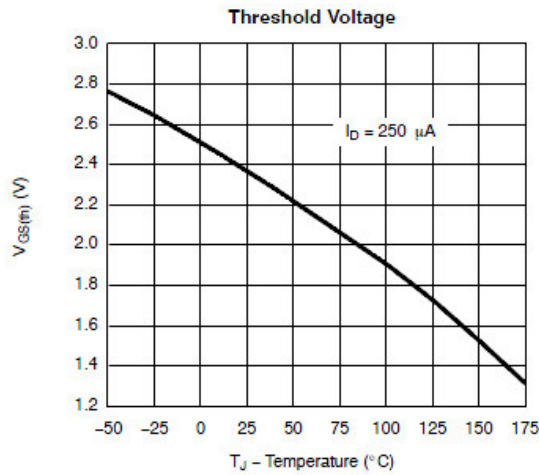
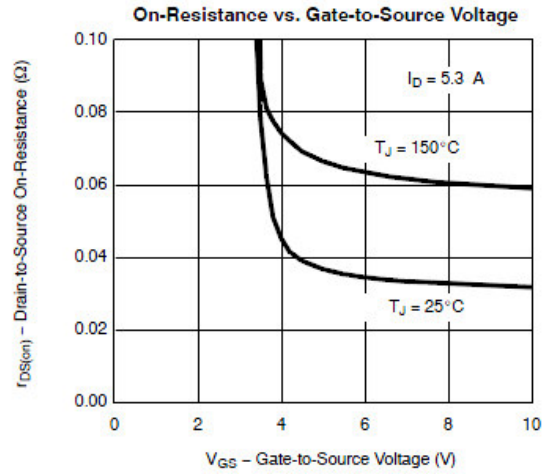
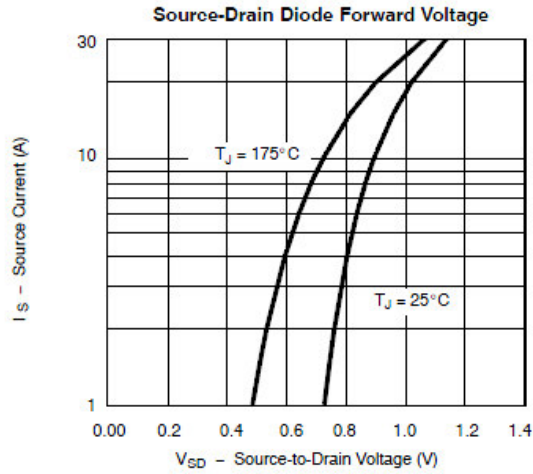



Typical Characteristics

Gate Charge Test Circuit & Waveform



Resistive Switching Test Circuit & Waveforms



Unclamped Inductive Switching Test Circuit & Waveforms





Package Information (SOP-8P)

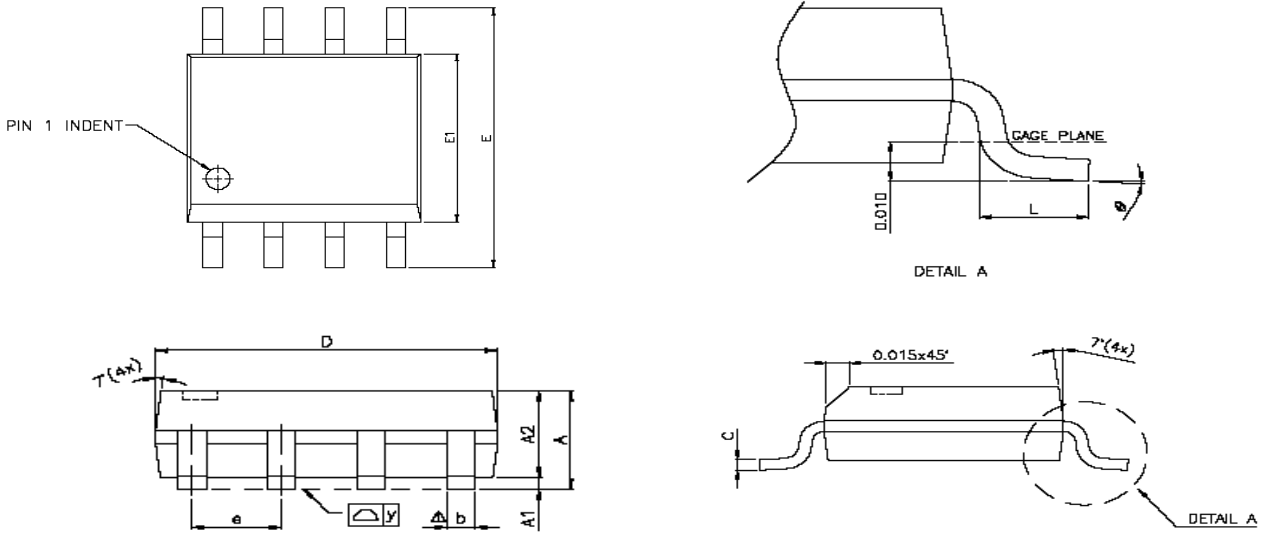

SYMBOLS	DIMENSIONS IN MILLIMETERS			DIMENSIONS IN INCHES		
	MIN	NOM	MAX	MIN	NOM	MAX
A	1.47	1.60	1.73	0.058	0.063	0.068
A1	0.10	—	0.25	0.004	—	0.010
A2	—	1.45	—	—	0.057	—
b	0.33	0.41	0.51	0.013	0.016	0.020
C	0.19	0.20	0.25	0.0075	0.008	0.0098
D	4.80	4.85	4.95	0.189	0.191	0.195
E	5.80	6.00	6.20	0.228	0.236	0.244
E1	3.80	3.90	4.00	0.150	0.154	0.157
e	—	1.27	—	—	0.050	—
L	0.38	0.71	1.27	0.015	0.028	0.050
Δy	—	—	0.076	—	—	0.003
\varnothing	0°	—	8°	0°	—	8°

©2010 Alfa-MOS Technology Co., Ltd.
 2F, No.80, Sec.1, Cheng Kung Rd., Nan Kang Dist., Taipei City 115, Taiwan (R.O.C.)
 Tel : 886 2) 2651 3928
 Fax : 886 2) 2786 8483
 ©http://www.alfa-mos.com