



### General Description

AFN4412W, N-Channel enhancement mode MOSFET, uses Advanced Trench Technology to provide excellent  $R_{DS(ON)}$ , low gate charge.

These devices are particularly suited for low voltage power management, and low in-line power loss are needed in commercial industrial surface mount applications.

### Features

- 30V/ 7.6A,  $R_{DS(ON)}=35m\Omega@V_{GS}=10V$
- 30V/ 6.2A,  $R_{DS(ON)}=42m\Omega@V_{GS}=4.5V$
- Super high density cell design for extremely low  $R_{DS(ON)}$
- SOP-8P package design

### Pin Description ( SOP-8P )

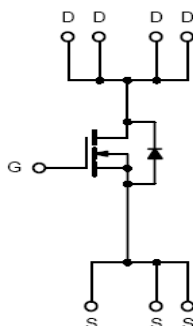
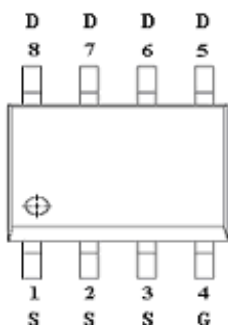

### Application

- DC/DC Converter
- Load Switch
- CCFL Inverter
- Power Management in Notebook Computer

### Pin Define

Pin	Symbol	Description
1	S	Source
2	S	Source
3	S	Source
4	G	Gate
5	D	Drain
6	D	Drain
7	D	Drain
8	D	Drain

### Ordering Information

Part Ordering No.	Part Marking	Package	Unit	Quantity
AFN4412WS8RG	4412W	SOP-8P	Tape & Reel	2500 EA

※ A Lot code

※ B Date code

※ AFN4412WS8RG : 13" Tape & Reel ; Pb- Free ; Halogen- Free



## Absolute Maximum Ratings

(T<sub>A</sub>=25°C Unless otherwise noted)

Parameter	Symbol	Typical	Unit
Drain-Source Voltage	V <sub>DSS</sub>	30	V
Gate –Source Voltage	V <sub>GSS</sub>	±20	V
Continuous Drain Current(T <sub>J</sub> =150°C)	I <sub>D</sub>	T <sub>A</sub> =25°C	7.6
		T <sub>A</sub> =70°C	6.2
Pulsed Drain Current	I <sub>DM</sub>	30	A
Continuous Source Current(Diode Conduction)	I <sub>S</sub>	2.6	A
Power Dissipation	P <sub>D</sub>	T <sub>A</sub> =25°C	2.8
		T <sub>A</sub> =70°C	1.8
Operating Junction Temperature	T <sub>J</sub>	150	°C
Storage Temperature Range	T <sub>STG</sub>	-55/150	°C
Thermal Resistance-Junction to Ambient	R <sub>θJA</sub>	62.5	°C/W

## Electrical Characteristics

(T<sub>A</sub>=25°C Unless otherwise noted)

Parameter	Symbol	Conditions	Min.	Typ	Max.	Unit
<b>Static</b>						
Drain-Source Breakdown Voltage	V <sub>(BR)DSS</sub>	V <sub>GS</sub> =0V, I <sub>D</sub> =250uA	30			V
Gate Threshold Voltage	V <sub>GS(th)</sub>	V <sub>DS</sub> =V <sub>GS</sub> , I <sub>D</sub> =250uA	1.0		2.0	V
Gate Leakage Current	I <sub>GSS</sub>	V <sub>DS</sub> =0V, V <sub>GS</sub> =±20V			±100	nA
Zero Gate Voltage Drain Current	I <sub>DSS</sub>	V <sub>DS</sub> =30V, V <sub>GS</sub> =0V			1	uA
		V <sub>DS</sub> =30V, V <sub>GS</sub> =0V T <sub>J</sub> =85°C			10	
On-State Drain Current	I <sub>D(on)</sub>	V <sub>DS</sub> ≥ 5V, V <sub>GS</sub> =10V	10			A
Drain-Source On-Resistance	R <sub>DS(on)</sub>	V <sub>GS</sub> =10V, I <sub>D</sub> =7.6A		25	35	mΩ
		V <sub>GS</sub> =4.5V, I <sub>D</sub> =6.2A		33	42	
Forward Transconductance	g <sub>FS</sub>	V <sub>DS</sub> =10V, I <sub>D</sub> =5.0A		16		S
Diode Forward Voltage	V <sub>SD</sub>	I <sub>S</sub> =3.4A, V <sub>GS</sub> =0V		0.85	1.2	V
<b>Dynamic</b>						
Total Gate Charge	Q <sub>g</sub>	V <sub>DS</sub> =15V, V <sub>GS</sub> =4.5V I <sub>D</sub> ≅5A		4	8	nC
Gate-Source Charge	Q <sub>gs</sub>			2		
Gate-Drain Charge	Q <sub>gd</sub>			1.2		
Input Capacitance	C <sub>iss</sub>	V <sub>DS</sub> =15V, V <sub>GS</sub> =0V f=1MHz		520		pF
Output Capacitance	C <sub>oss</sub>			80		
Reverse Transfer Capacitance	C <sub>rss</sub>			40		
Turn-On Time	t <sub>d(on)</sub>	V <sub>DD</sub> =15V, R <sub>L</sub> =3Ω I <sub>D</sub> ≅5A, V <sub>GEN</sub> =10V R <sub>G</sub> =1Ω		5	10	ns
	t <sub>r</sub>			10	18	
Turn-Off Time	t <sub>d(off)</sub>			10	20	
	t <sub>f</sub>			6	12	



## Typical Characteristics

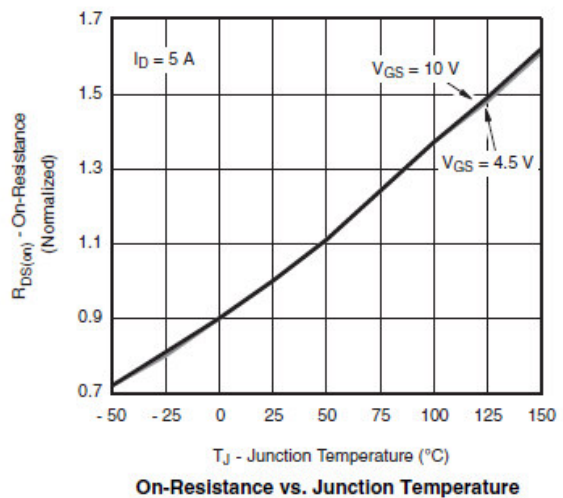
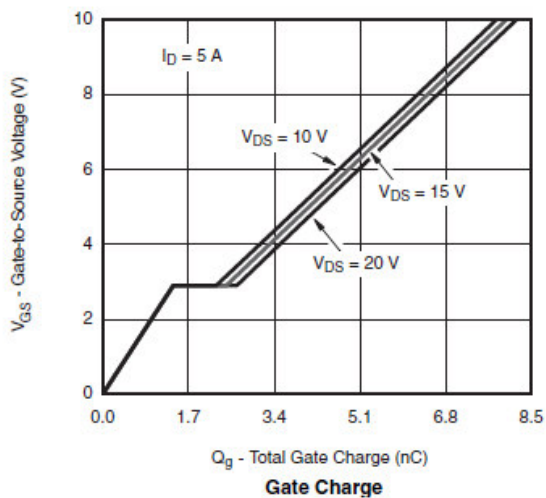
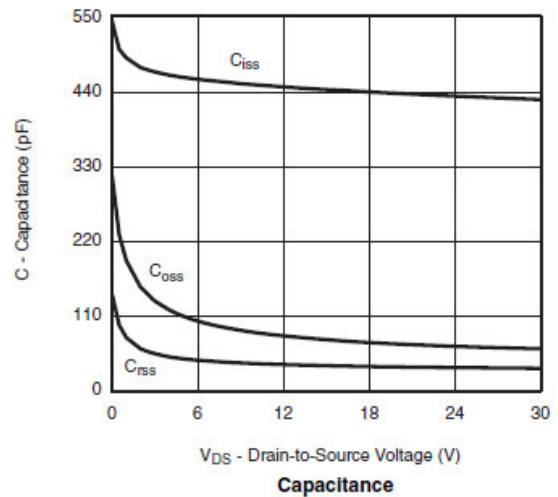
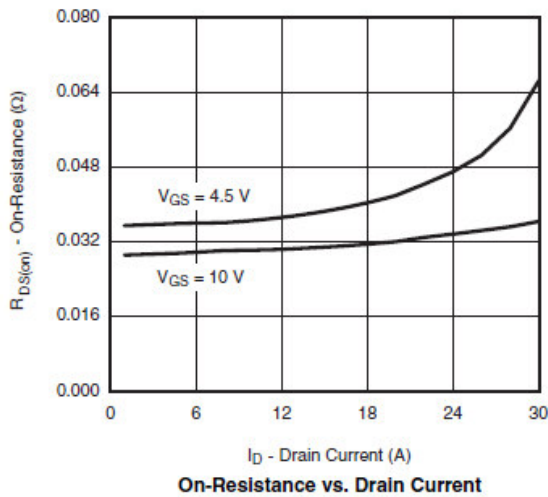
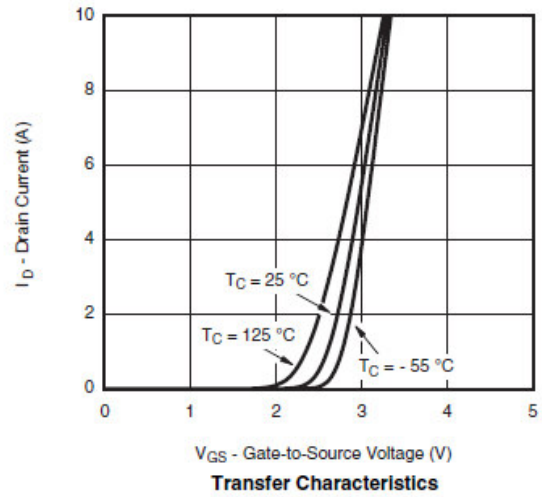
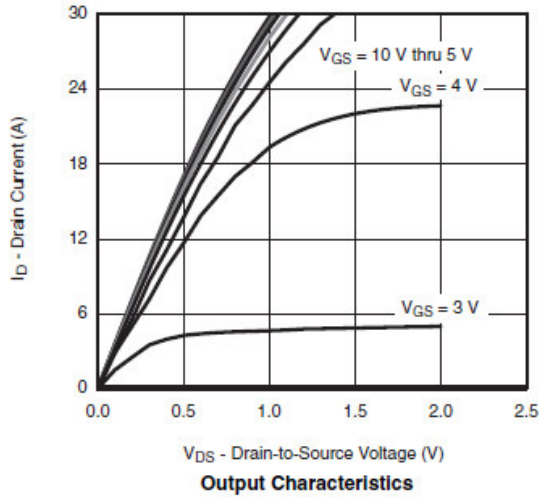



## Typical Characteristics

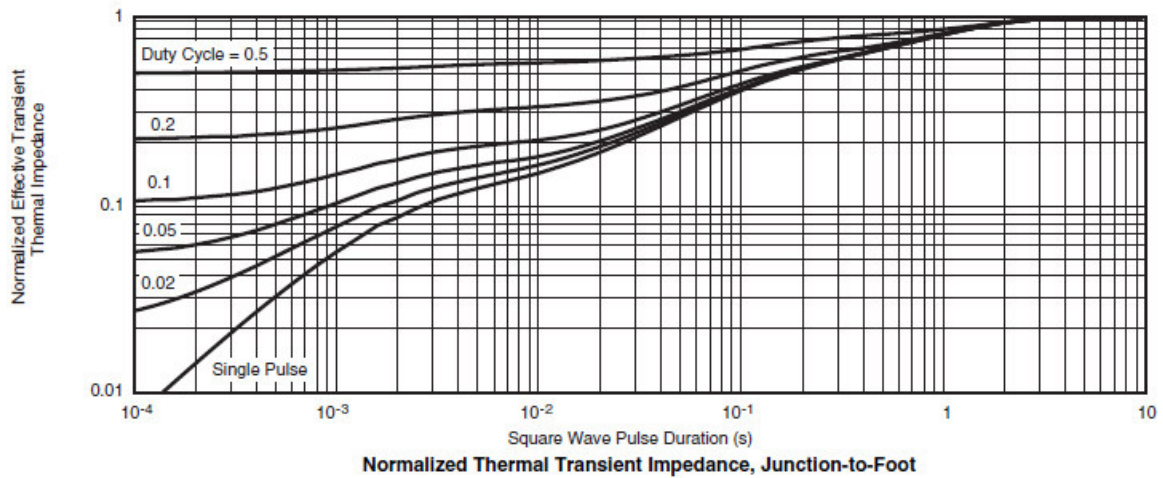
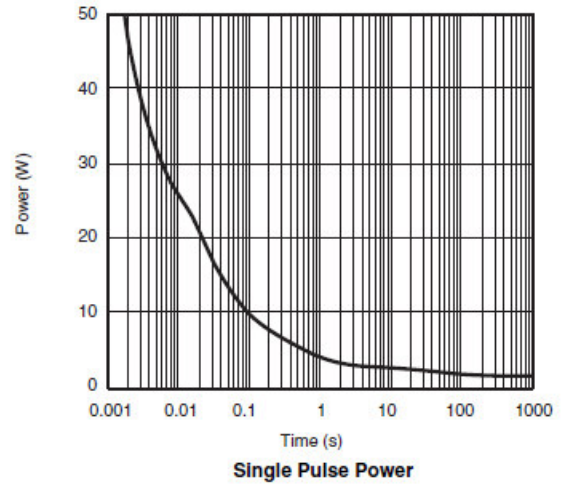
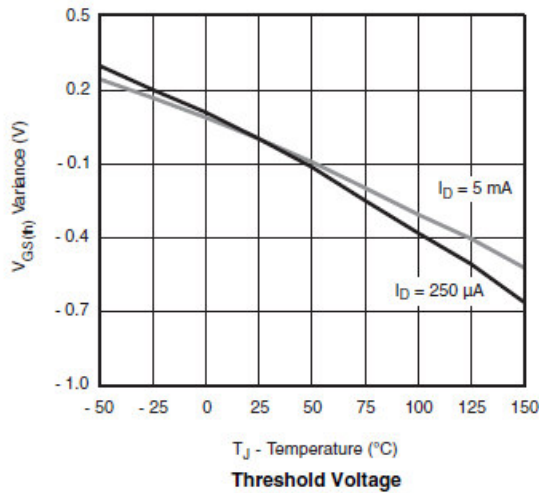
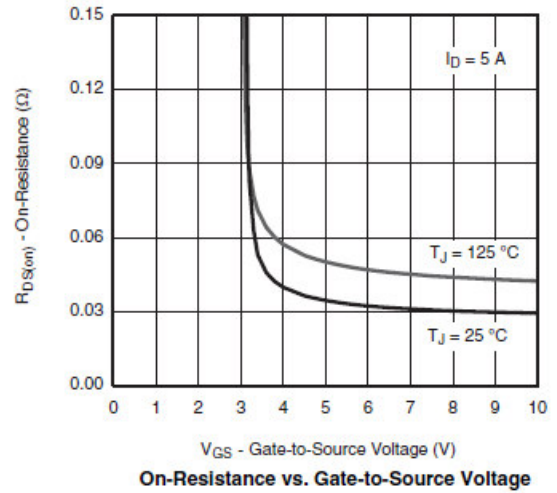
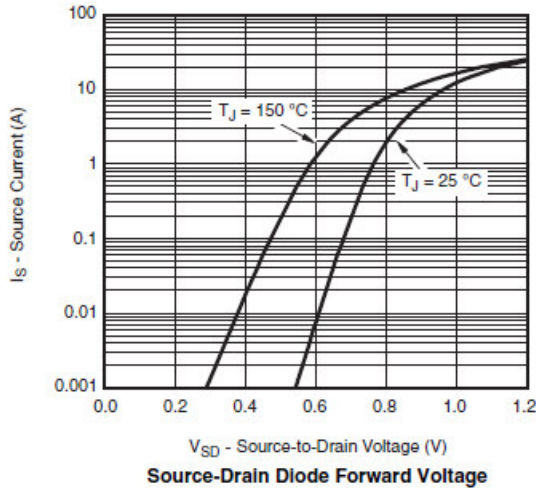



**Typical Characteristics**

Gate Charge Test Circuit & Waveform



Resistive Switching Test Circuit & Waveforms



Unclamped Inductive Switching Test Circuit & Waveforms





**Package Information ( SOP-8P )**

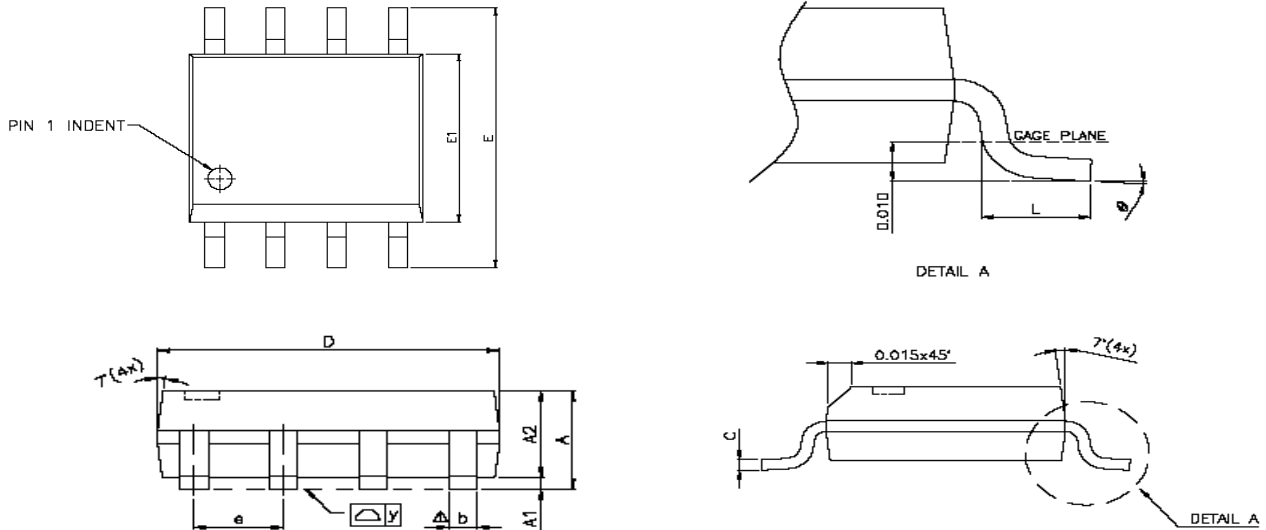

SYMBOLS	DIMENSIONS IN MILLIMETERS			DIMENSIONS IN INCHES		
	MIN	NOM	MAX	MIN	NOM	MAX
A	1.47	1.60	1.73	0.058	0.063	0.068
A1	0.10	—	0.25	0.004	—	0.010
A2	—	1.45	—	—	0.057	—
b	0.33	0.41	0.51	0.013	0.016	0.020
C	0.19	0.20	0.25	0.0075	0.008	0.0098
D	4.80	4.85	4.95	0.189	0.191	0.195
E	5.80	6.00	6.20	0.228	0.236	0.244
E1	3.80	3.90	4.00	0.150	0.154	0.157
e	—	1.27	—	—	0.050	—
L	0.38	0.71	1.27	0.015	0.028	0.050
$\Delta$ y	—	—	0.076	—	—	0.003
$\varnothing$	0°	—	8°	0°	—	8°

©2010 Alfa-MOS Technology Corp.  
 2F, No.80, Sec.1, Cheng Kung Rd., Nan Kang Dist., Taipei City 115, Taiwan (R.O.C.)  
 Tel : 886 2) 2651 3928  
 Fax : 886 2) 2786 8483  
 ©http://www.alfa-mos.com