



General Description

AFN3814W, N-Channel enhancement mode MOSFET, uses Advanced Trench Technology to provide excellent $R_{DS(ON)}$, low gate charge.

These devices are particularly suited for low voltage power management, and low in-line power loss are needed in commercial industrial surface mount applications.

Features

- 20V/ 14A, $R_{DS(ON)}=14m\Omega@V_{GS}=4.5V$
- 20V/ 12A, $R_{DS(ON)}=18m\Omega@V_{GS}=2.5V$
- 20V/ 10A, $R_{DS(ON)}=30m\Omega@V_{GS}=1.8V$
- Super high density cell design for extremely low $R_{DS(ON)}$
- DFN3X3-8L package design

Pin Description (DFN3X3-8L)

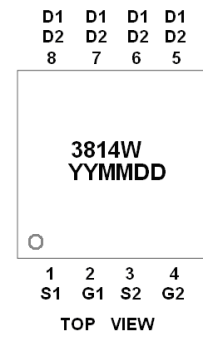
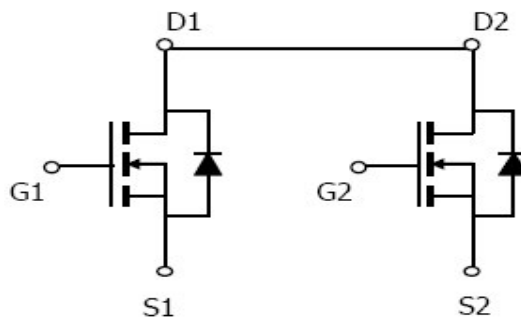
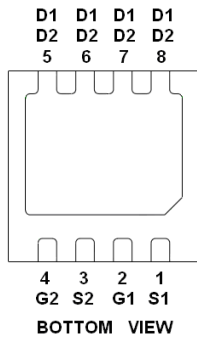

Application

- Load Switch
- Portable Equipment
- Battery Powered System

Pin Define

Pin	Symbol	Description
1	S1	Source 1
2	G1	Gate 1
3	S2	Source 2
4	G2	Gate 2
5	D1/D2	Drain 1 / Drain 2
6	D1/D2	Drain 1 / Drain 2
7	D1/D2	Drain 1 / Drain 2
8	D1/D2	Drain 1 / Drain 2

Ordering Information

Part Ordering No.	Part Marking	Package	Unit	Quantity
AFN3814WFN338RG	3814W	DFN3X3-8L	Tape & Reel	5000 EA

※ YY year code

※ MM month code

※ DD date code

※ AFN3814WFN338RG : 13" Tape & Reel ; Pb- Free ; Halogen- Free



Absolute Maximum Ratings

(T_A=25°C Unless otherwise noted)

Parameter	Symbol	Typical	Unit
Drain-Source Voltage	V _{DSS}	20	V
Gate –Source Voltage	V _{GSS}	±12	V
Continuous Drain Current(T _J =150°C)	I _D	T _A =25°C	14
		T _A =70°C	10
Pulsed Drain Current	I _{DM}	20	A
Continuous Source Current(Diode Conduction)	I _S	1.5	A
Power Dissipation	P _D	T _A =25°C	2
		T _A =70°C	1.5
Operating Junction Temperature	T _J	150	°C
Storage Temperature Range	T _{STG}	-55/150	°C
Thermal Resistance-Junction to Ambient	R _{θJA}	62.5	°C/W

Electrical Characteristics

(T_A=25°C Unless otherwise noted)

Parameter	Symbol	Conditions	Min.	Typ	Max.	Unit
Static						
Drain-Source Breakdown Voltage	V _{(BR)DSS}	V _{GS} =0V, I _D =250uA	20			V
Gate Threshold Voltage	V _{GS(th)}	V _{DS} =V _{GS} , I _D =250uA	0.4		1.0	
Gate Leakage Current	I _{GSS}	V _{DS} =0V, V _{GS} =±12V			±100	nA
Zero Gate Voltage Drain Current	I _{DSS}	V _{DS} =20V, V _{GS} =0V			1	uA
		V _{DS} =20V, V _{GS} =0V T _J =85°C			10	
On-State Drain Current	I _{D(on)}	V _{DS} ≥ 5V, V _{GS} =4.5V	30			A
Drain-Source On-Resistance	R _{DS(on)}	V _{GS} =4.5V, I _D =14A		10	14	mΩ
		V _{GS} =2.5V, I _D =12A		14	18	
		V _{GS} =1.8V, I _D =10A		23	30	
Forward Transconductance	g _{FS}	V _{DS} =10V, I _D =7.0A		40		S
Diode Forward Voltage	V _{SD}	I _S =1.6A, V _{GS} =0V		0.8	1.3	V
Dynamic						
Total Gate Charge	Q _g	V _{DS} =10V, V _{GS} =4.5V I _D ≧6.0A		13	19	nC
Gate-Source Charge	Q _{gs}			2.8		
Gate-Drain Charge	Q _{gd}			2.0		
Input Capacitance	C _{iss}	V _{DS} =10V, V _{GS} =0V f=1MHz		1450		pF
Output Capacitance	C _{oss}			285		
Reverse Transfer Capacitance	C _{rss}			145		
Turn-On Time	t _{d(on)}	V _{DD} =10V, R _L =1.3Ω I _D ≧6.0A, V _{GEN} =10V R _G =1Ω		10	20	ns
	t _r			10	20	
Turn-Off Time	t _{d(off)}			25	40	
	t _f			10	20	



Typical Characteristics

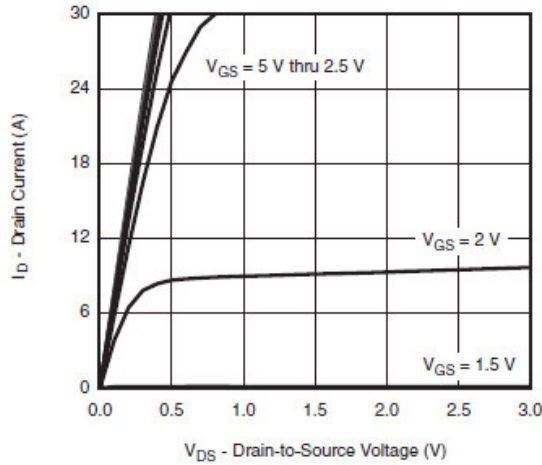

Output Characteristics

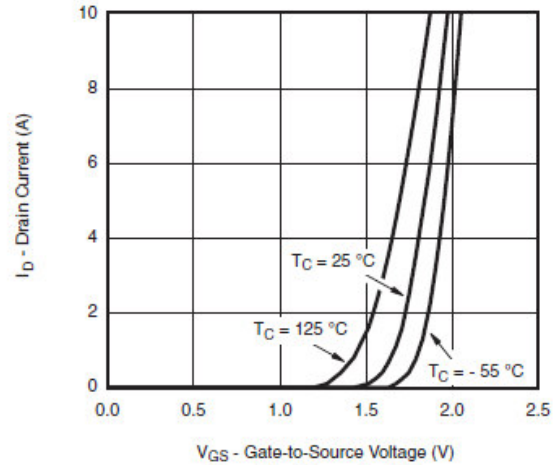

Transfer Characteristics

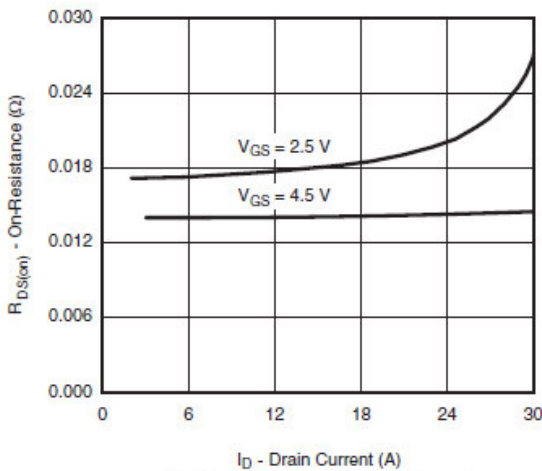

On-Resistance vs. Drain Current

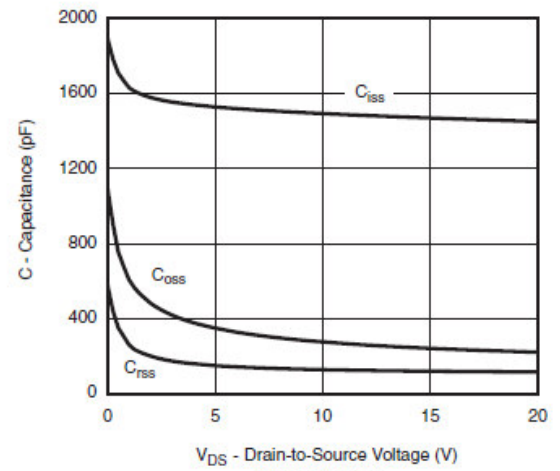

Capacitance

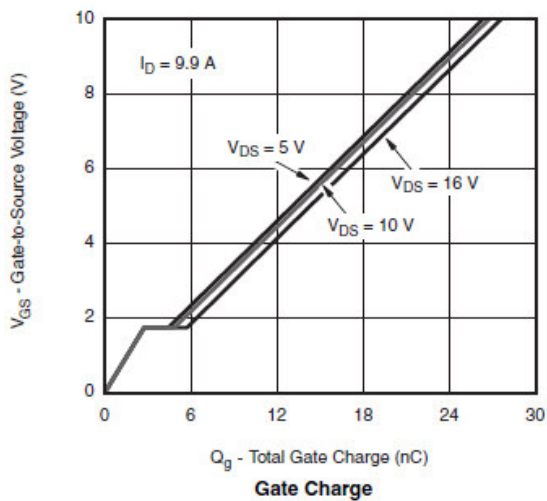

Gate Charge

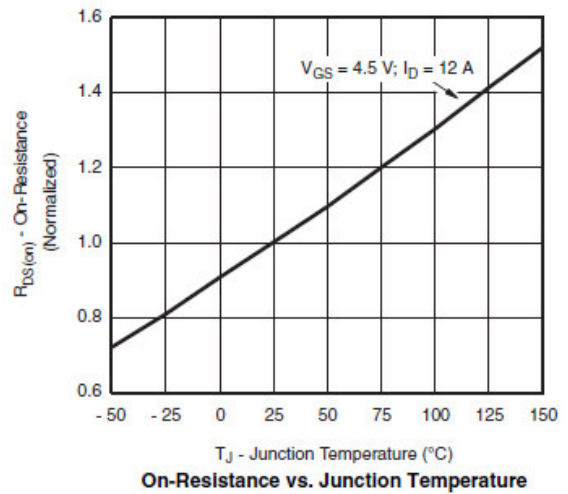

On-Resistance vs. Junction Temperature



Typical Characteristics

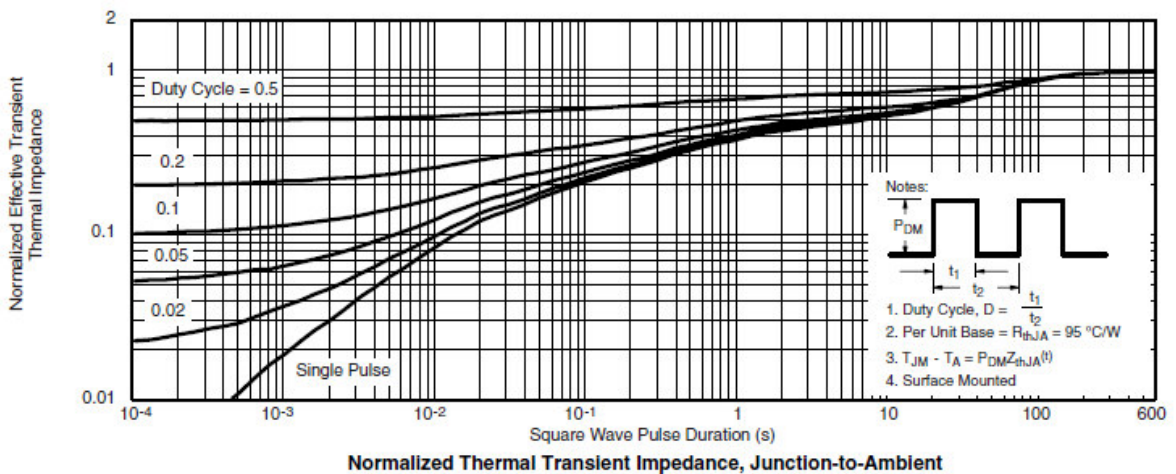
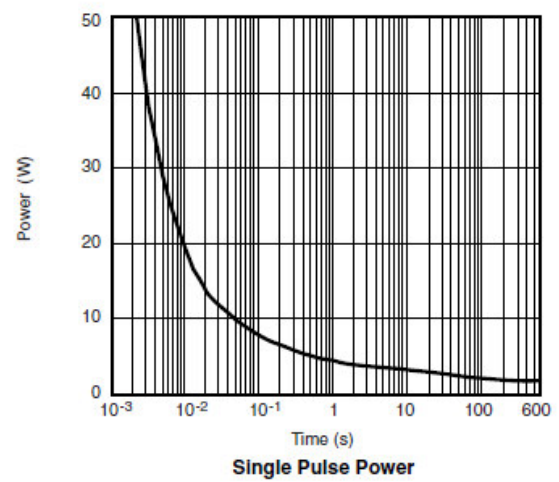
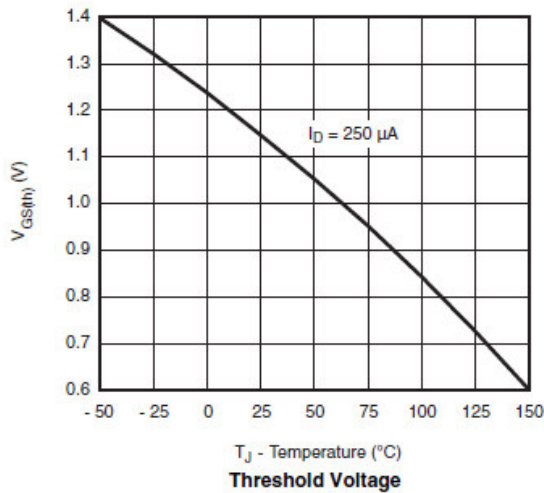
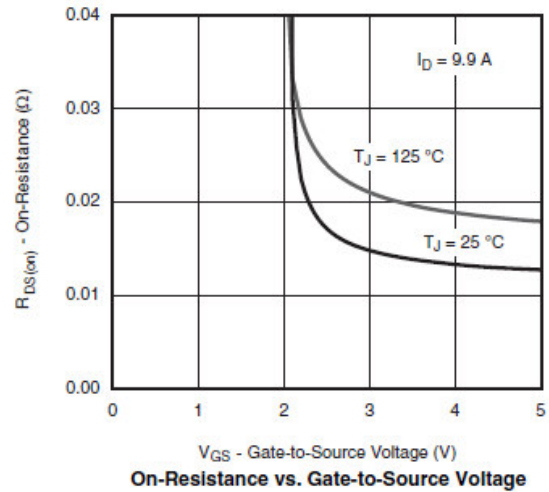
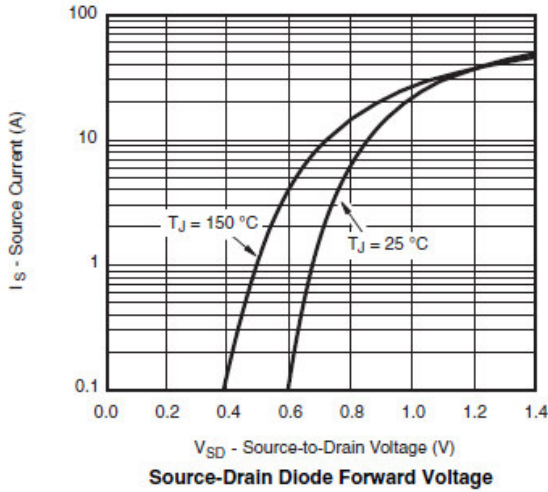



Typical Characteristics

Gate Charge Test Circuit & Waveform



Resistive Switching Test Circuit & Waveforms



Unclamped Inductive Switching Test Circuit & Waveforms





Package Information (DFN3X3-8L)

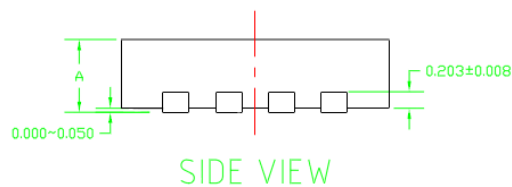
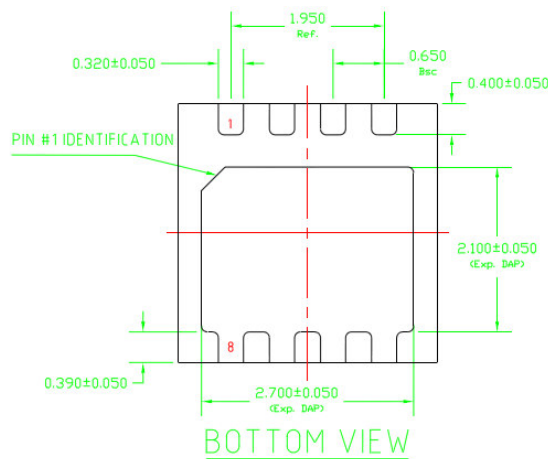
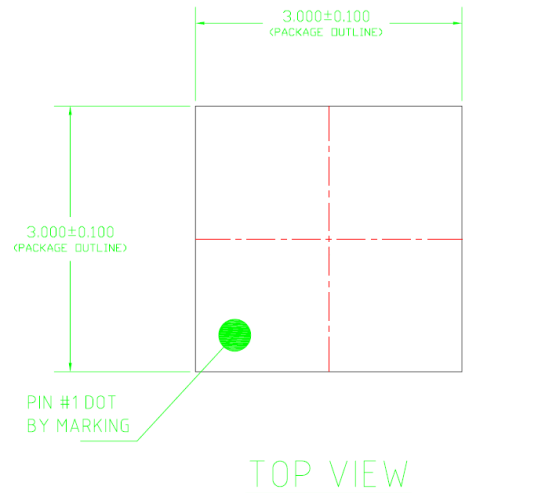

©2010 Alfa-MOS Technology Corp.
2F, No.80, Sec.1, Cheng Kung Rd., Nan Kang Dist., Taipei City 115, Taiwan (R.O.C.)
Tel : 886 2) 2651 3928
Fax : 886 2) 2786 8483
©<http://www.alfa-mos.com>