



General Description

AFN3806W, N-Channel enhancement mode MOSFET, uses Advanced Trench Technology to provide excellent $R_{DS(ON)}$, low gate charge.

These devices are particularly suited for low voltage power management, and low in-line power loss are needed in commercial industrial surface mount applications.

Features

- 20V/ 9A, $R_{DS(ON)}=26m\Omega@V_{GS}=4.5V$
- 20V/ 8A, $R_{DS(ON)}=32m\Omega@V_{GS}=2.5V$
- 20V/ 6A, $R_{DS(ON)}=42m\Omega@V_{GS}=1.8V$
- Super high density cell design for extremely low $R_{DS(ON)}$
- DFN3X3-8L package design

Pin Description (DFN3X3-8L)

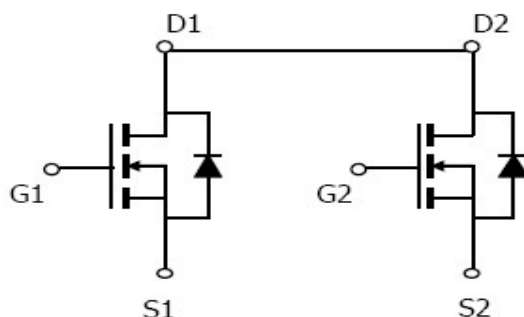
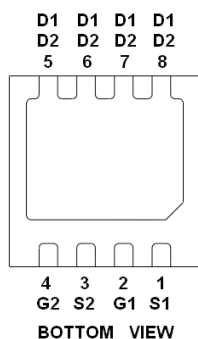

Application

- Load Switch
- Portable Equipment
- Battery Powered System

Pin Define

Pin	Symbol	Description
1	S1	Source 1
2	G1	Gate 1
3	S2	Source 2
4	G2	Gate 2
5	D1/D2	Drain 1 / Drain 2
6	D1/D2	Drain 1 / Drain 2
7	D1/D2	Drain 1 / Drain 2
8	D1/D2	Drain 1 / Drain 2

Ordering Information

Part Ordering No.	Part Marking	Package	Unit	Quantity
AFN3806WFN338RG	3806W	DFN3X3-8L	Tape & Reel	5000 EA

※ YY year code

※ MM month code

※ DD date code

※ AFN3806WFN338RG : 13" Tape & Reel ; Pb- Free ; Halogen- Free



Absolute Maximum Ratings

(T_A=25°C Unless otherwise noted)

Parameter	Symbol	Typical	Unit
Drain-Source Voltage	V _{DSS}	20	V
Gate –Source Voltage	V _{GSS}	±12	V
Continuous Drain Current(T _J =150°C)	I _D	T _A =25°C	9
		T _A =70°C	6
Pulsed Drain Current	I _{DM}	20	A
Continuous Source Current(Diode Conduction)	I _S	1.5	A
Power Dissipation	P _D	T _A =25°C	2
		T _A =70°C	1.5
Operating Junction Temperature	T _J	150	°C
Storage Temperature Range	T _{STG}	-55/150	°C
Thermal Resistance-Junction to Ambient	R _{θJA}	62.5	°C/W

Electrical Characteristics

(T_A=25°C Unless otherwise noted)

Parameter	Symbol	Conditions	Min.	Typ	Max.	Unit
Static						
Drain-Source Breakdown Voltage	V _{(BR)DSS}	V _{GS} =0V, I _D =250uA	20			V
Gate Threshold Voltage	V _{GS(th)}	V _{DS} =V _{GS} , I _D =250uA	0.3		0.8	
Gate Leakage Current	I _{GSS}	V _{DS} =0V, V _{GS} =±12V			±100	nA
Zero Gate Voltage Drain Current	I _{DSS}	V _{DS} =16V, V _{GS} =0V			1	uA
		V _{DS} =16V, V _{GS} =0V T _J =85°C			30	
On-State Drain Current	I _{D(on)}	V _{DS} ≥5V, V _{GS} =4.5V	10			A
Drain-Source On-Resistance	R _{DS(on)}	V _{GS} = 4.5V, I _D =9A		21	26	mΩ
		V _{GS} = 2.5V, I _D =8A		24	32	
		V _{GS} = 1.8V, I _D =6A		31	42	
Forward Transconductance	g _{FS}	V _{DS} =5V, I _D =7A		25		S
Diode Forward Voltage	V _{SD}	I _S =1.6A, V _{GS} =0V		0.7	1.2	V
Dynamic						
Total Gate Charge	Q _g	V _{DS} =10V, V _{GS} =4.5V I _D ≧7.0A		650		pC
Gate-Source Charge	Q _{gs}			200		
Gate-Drain Charge	Q _{gd}			180		
Input Capacitance	C _{iss}	V _{DS} =20V, V _{GS} =0V f=1MHz		700		pF
Output Capacitance	C _{oss}			75		
Reverse Transfer Capacitance	C _{rss}			45		
Turn-On Time	t _{d(on)}	V _{DD} =10V, R _L =1.4Ω I _D ≧1.0A, V _{GEN} =4.5V		8	12	ns
	t _r			12	20	
Turn-Off Time	t _{d(off)}	R _G =3Ω		32	40	
	t _f			10	15	



Typical Characteristics

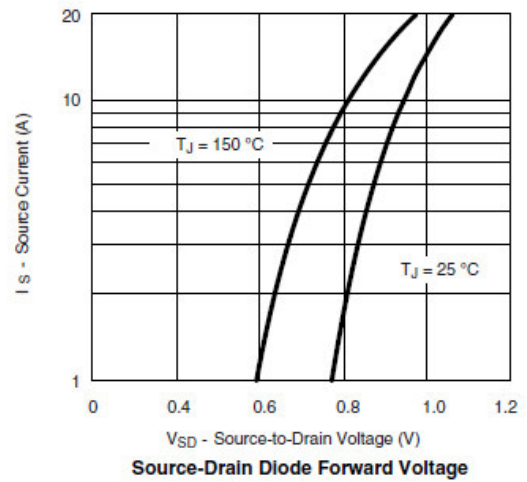
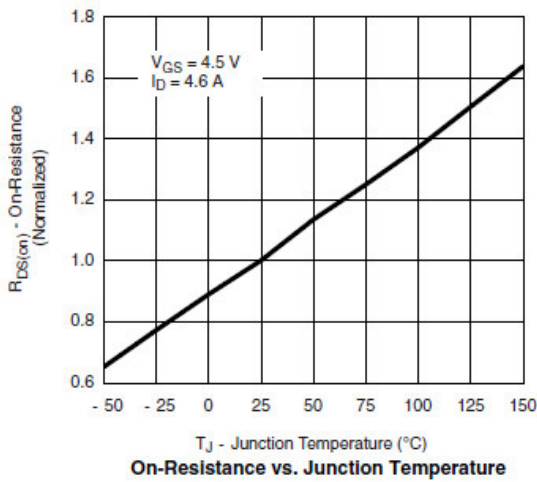
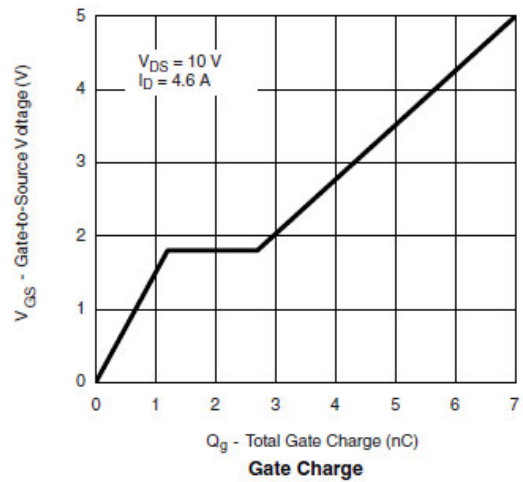
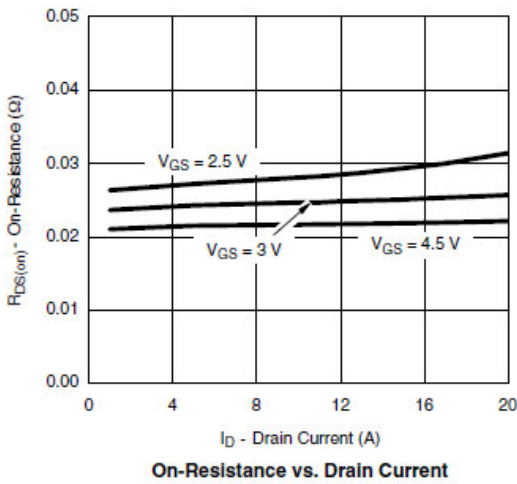
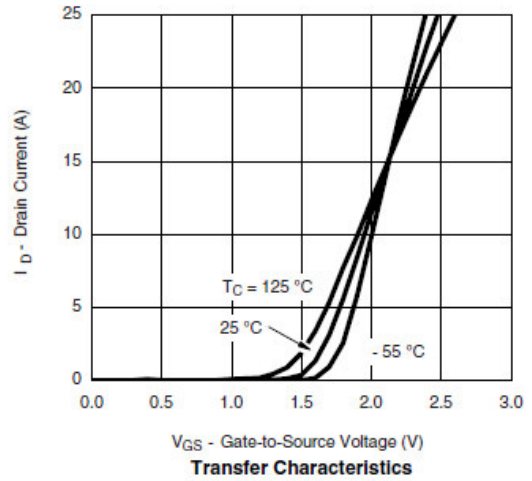
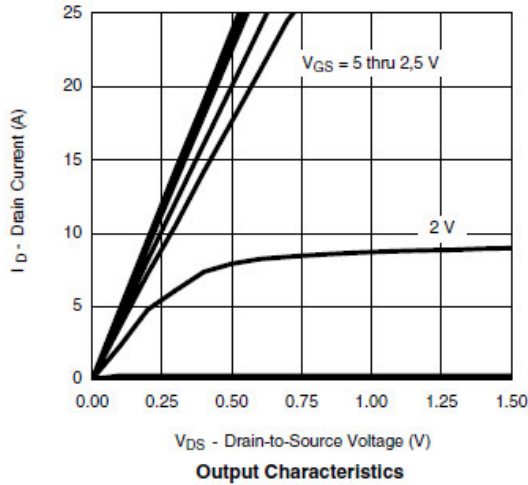



Typical Characteristics

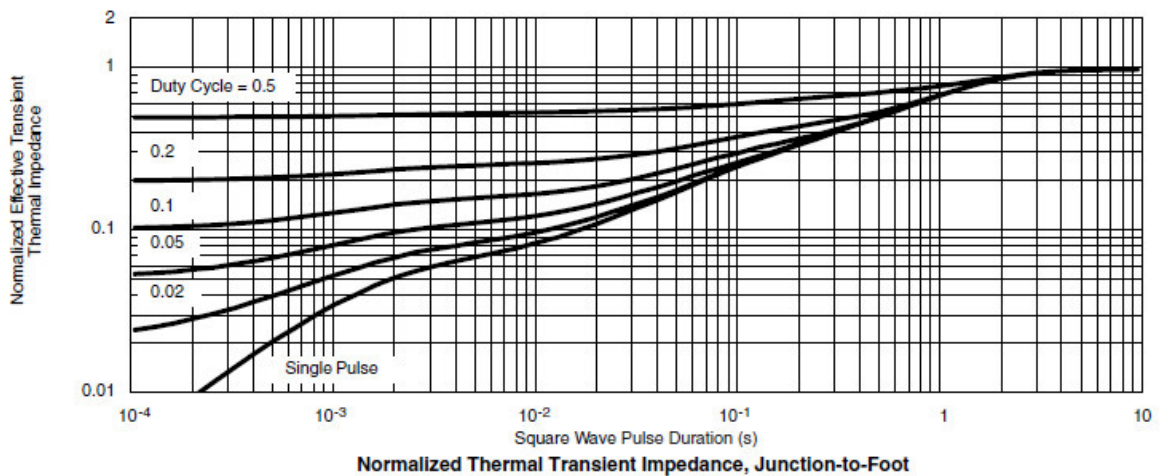
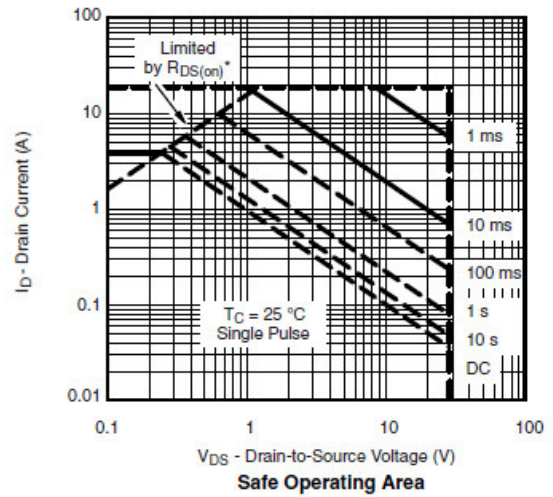
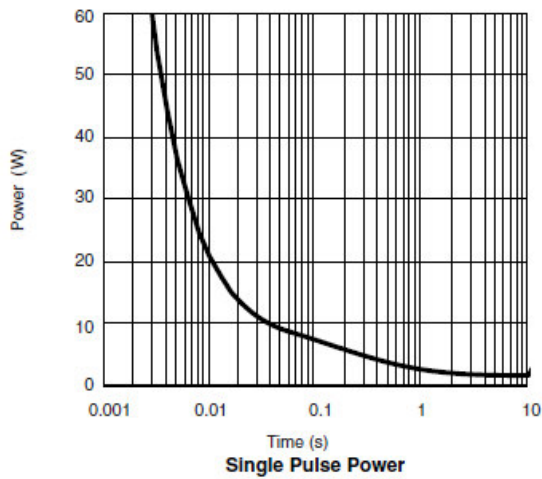
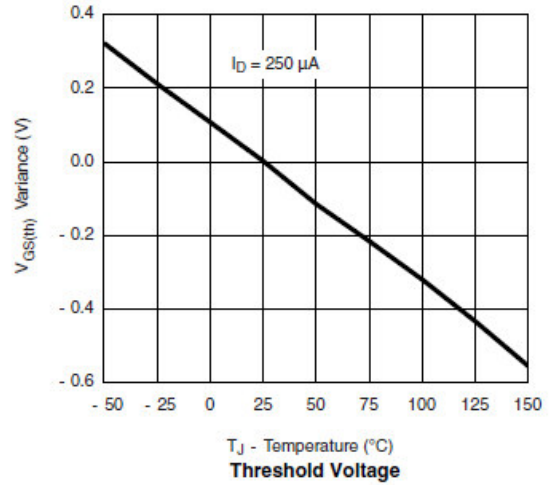
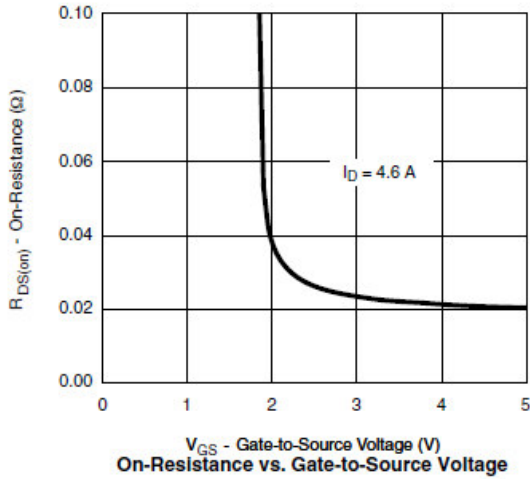



Typical Characteristics

Gate Charge Test Circuit & Waveform



Resistive Switching Test Circuit & Waveforms



Unclamped Inductive Switching Test Circuit & Waveforms





Package Information (DFN3X3-8L)

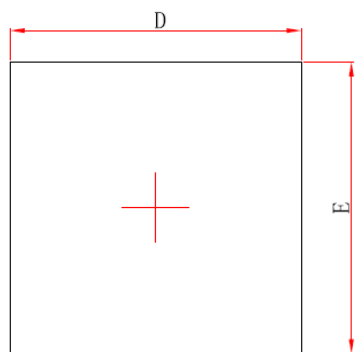

Top View

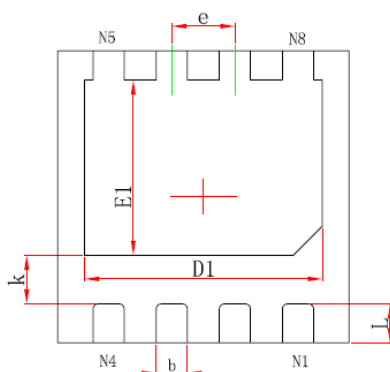

Bottom View

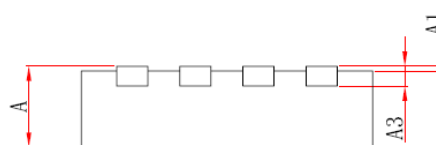

Side View

Symbol	Dimensions In Millimeters		Dimensions In Inches	
	Min.	Max.	Min.	Max.
A	0.800	0.900	0.031	0.035
A1	0.000	0.050	0.000	0.002
A3	0.203REF.		0.008REF.	
D	2.924	3.076	0.115	0.121
E	2.924	3.076	0.115	0.121
D1	2.350	2.550	0.093	0.100
E1	1.700	1.900	0.067	0.075
k	0.450	0.550	0.018	0.022
b	0.270	0.370	0.011	0.015
e	0.650TYP.		0.026TYP.	
L	0.324	0.476	0.013	0.019

©2010 Alfa-MOS Technology Corp.
2F, No.80, Sec.1, Cheng Kung Rd., Nan Kang Dist., Taipei City 115, Taiwan (R.O.C.)
Tel : 886 2) 2651 3928
Fax : 886 2) 2786 8483
©http://www.alfa-mos.com