



## General Description

AFN3684S, N-Channel enhancement mode MOSFET, uses Advanced Trench Technology to provide excellent  $R_{DS(ON)}$ , low gate charge.

These devices are particularly suited for low voltage power management, and low in-line power loss are needed in commercial industrial surface mount applications.

## Features

- 30V/30A,  $R_{DS(ON)}=9m\Omega@V_{GS}=10V$
- 30V/18A,  $R_{DS(ON)}=13m\Omega@V_{GS}=4.5V$
- Super high density cell design for extremely low  $R_{DS(ON)}$
- TO-220-3L package design

## Pin Description ( TO-220-3L )

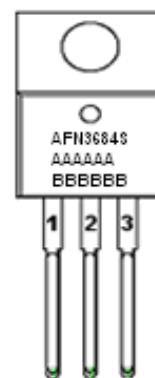
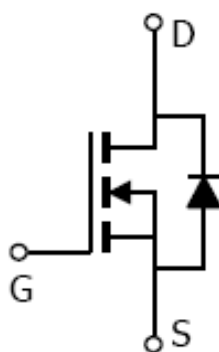
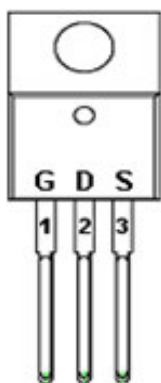

## Application

- Buck Converter
  - Low Side
- Synchronous Rectifier
  - Secondary Rectifier

## Pin Define

Pin	Symbol	Description
1	G	Gate
2	D	Drain
3	S	Source

## Ordering Information

Part Ordering No.	Part Marking	Package	Unit	Quantity
AFN3684ST220TG	AFN3684S AAAAAA BBBBBB	TO-220-3L	Tube	60 EA

※ A Lot code

※ B Date code

※ AFN3684ST220TG : Tube ; Pb- Free ; Halogen- Free



**Absolute Maximum Ratings**

(T<sub>A</sub>=25°C Unless otherwise noted)

Parameter	Symbol	Typical	Unit
Drain-Source Voltage	V <sub>DSS</sub>	30	V
Gate –Source Voltage	V <sub>GSS</sub>	±20	V
Continuous Drain Current(T <sub>J</sub> =150°C)	I <sub>D</sub>	T <sub>A</sub> =25°C	30
		T <sub>A</sub> =70°C	18
Pulsed Drain Current	I <sub>DM</sub>	40	A
Continuous Source Current(Diode Conduction)	I <sub>S</sub>	9.0	A
Power Dissipation	P <sub>D</sub>	T <sub>A</sub> =25°C	75
		T <sub>A</sub> =70°C	150
Operating Junction Temperature	T <sub>J</sub>	150	°C
Storage Temperature Range	T <sub>STG</sub>	-55/150	°C
Thermal Resistance-Junction to Ambient	R <sub>θJA</sub>	62.5	°C/W

**Electrical Characteristics**

(T<sub>A</sub>=25°C Unless otherwise noted)

Parameter	Symbol	Conditions	Min.	Typ	Max.	Unit
<b>Static</b>						
Drain-Source Breakdown Voltage	V <sub>(BR)DSS</sub>	V <sub>GS</sub> =0V, I <sub>D</sub> =250uA	30			V
Gate Threshold Voltage	V <sub>GS(th)</sub>	V <sub>DS</sub> =V <sub>GS</sub> , I <sub>D</sub> =250uA	1.0		2.0	V
Gate Leakage Current	I <sub>GSS</sub>	V <sub>DS</sub> =0V, V <sub>GS</sub> =±20V			±100	nA
Zero Gate Voltage Drain Current	I <sub>DSS</sub>	V <sub>DS</sub> =24V, V <sub>GS</sub> =0V			1	uA
		V <sub>DS</sub> =24V, V <sub>GS</sub> =0V T <sub>J</sub> =85°C			10	
On-State Drain Current	I <sub>D(on)</sub>	V <sub>DS</sub> ≥ 5V, V <sub>GS</sub> =10V	15			A
Drain-Source On-Resistance	R <sub>DS(on)</sub>	V <sub>GS</sub> =10V, I <sub>D</sub> =30A		7.5	9	mΩ
		V <sub>GS</sub> =4.5V, I <sub>D</sub> =18A		11	13	
Forward Transconductance	g <sub>FS</sub>	V <sub>DS</sub> =15V, I <sub>D</sub> =10A		24		S
Diode Forward Voltage	V <sub>SD</sub>	I <sub>S</sub> =12A, V <sub>GS</sub> =0V		0.8	1.3	V
<b>Dynamic</b>						
Total Gate Charge	Q <sub>g</sub>	V <sub>DS</sub> =15V, V <sub>GS</sub> =4.5V I <sub>D</sub> ≡10A		10	15	nC
Gate-Source Charge	Q <sub>gs</sub>			3.8		
Gate-Drain Charge	Q <sub>gd</sub>			3.2		
Input Capacitance	C <sub>iss</sub>	V <sub>DS</sub> =15V, V <sub>GS</sub> =0V f=1MHz		950		pF
Output Capacitance	C <sub>oss</sub>			200		
Reverse Transfer Capacitance	C <sub>rss</sub>			85		
Turn-On Time	t <sub>d(on)</sub>	V <sub>DD</sub> =15V, R <sub>L</sub> =1.5Ω I <sub>D</sub> ≡10A, V <sub>GEN</sub> =10V R <sub>G</sub> =1Ω		10	20	ns
	t <sub>r</sub>			10	20	
Turn-Off Time	t <sub>d(off)</sub>			20	35	
	t <sub>f</sub>			10	20	



## Typical Characteristics

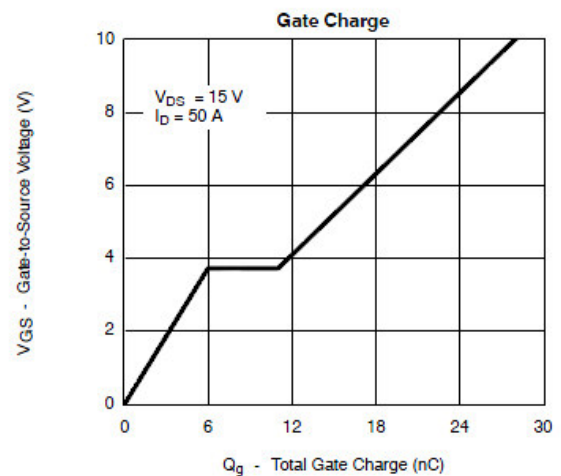
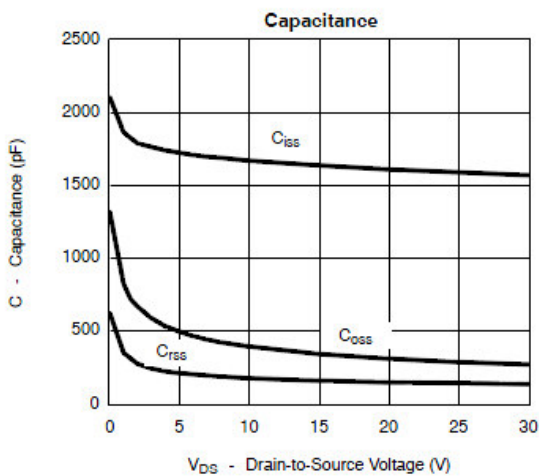
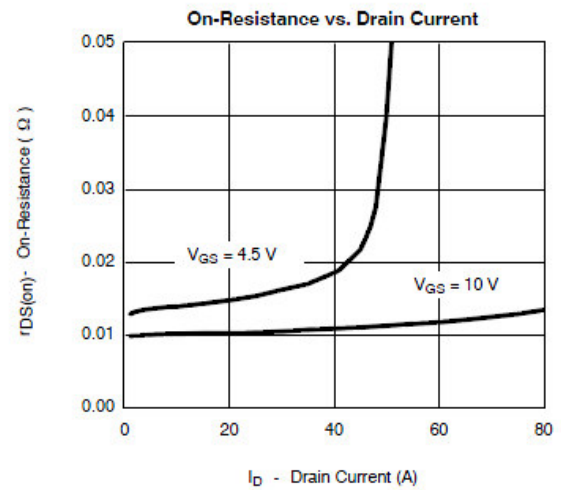
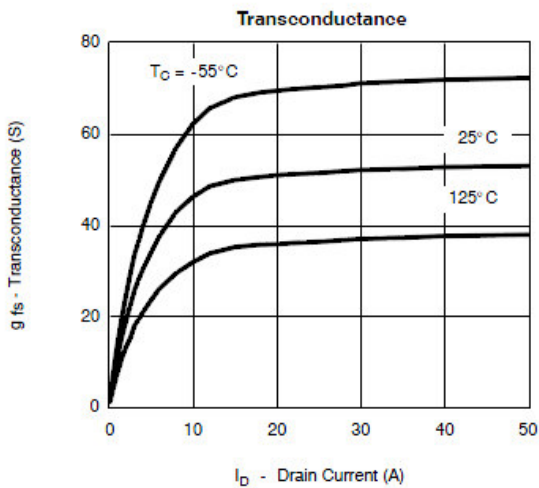
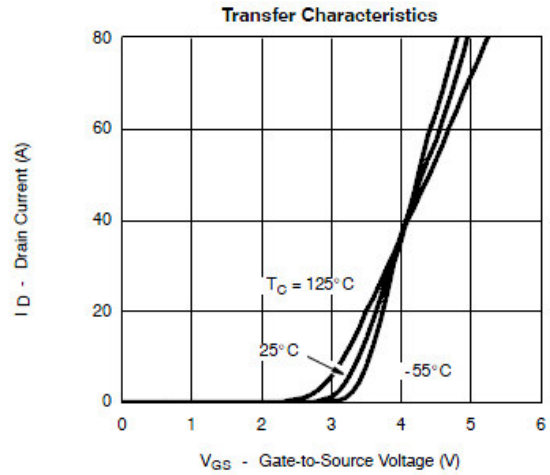
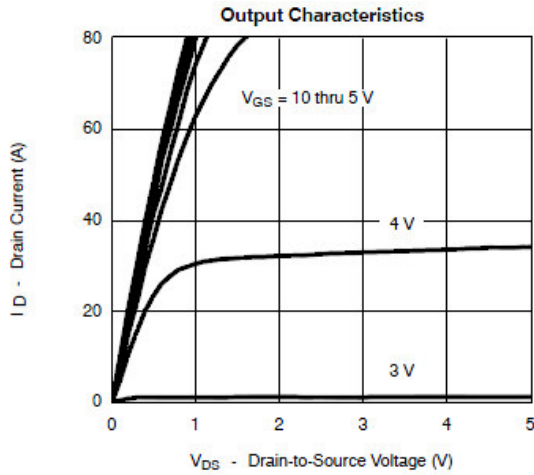



## Typical Characteristics

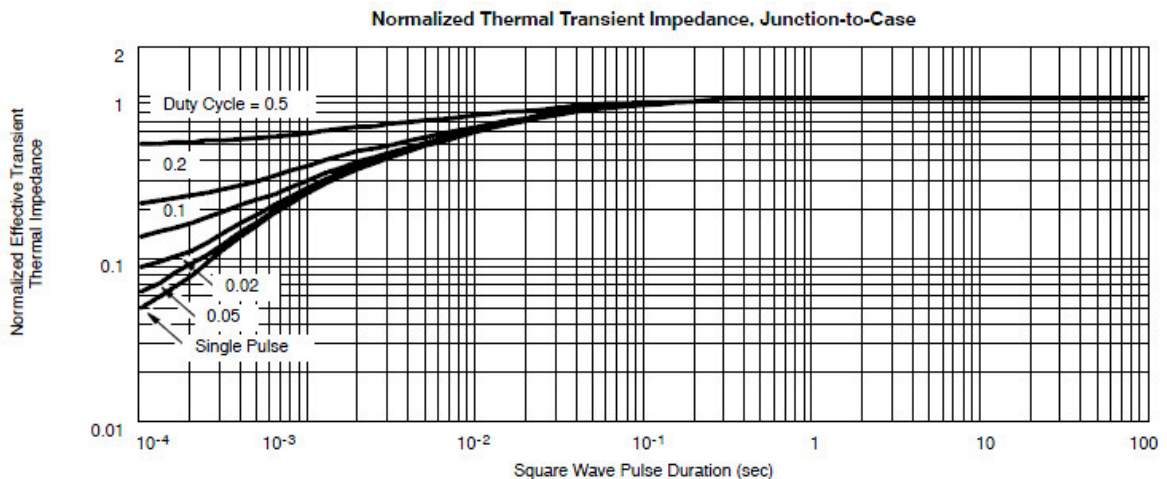
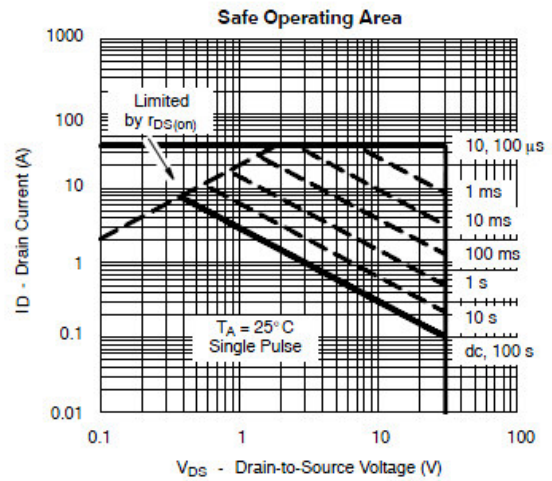
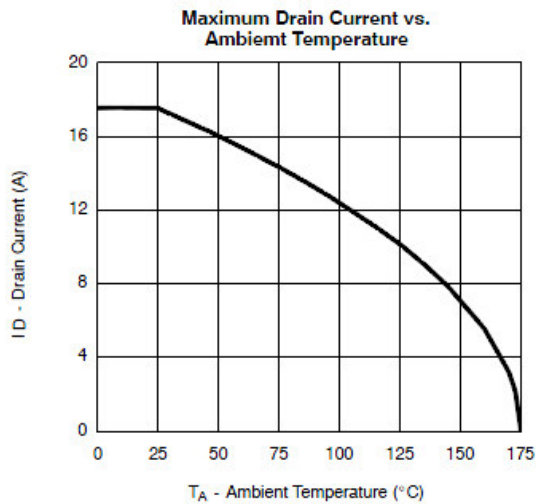
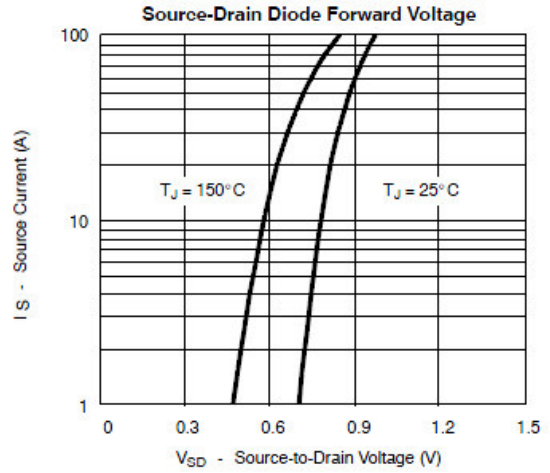
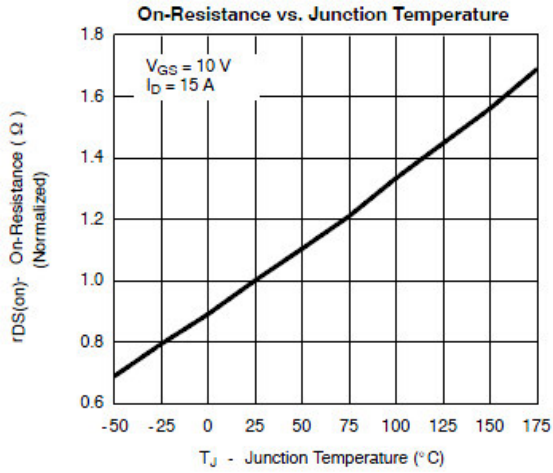



**Typical Characteristics**

Gate Charge Test Circuit & Waveform



Resistive Switching Test Circuit & Waveforms



Unclamped Inductive Switching Test Circuit & Waveforms





**Package Information ( TO-220-3L )**

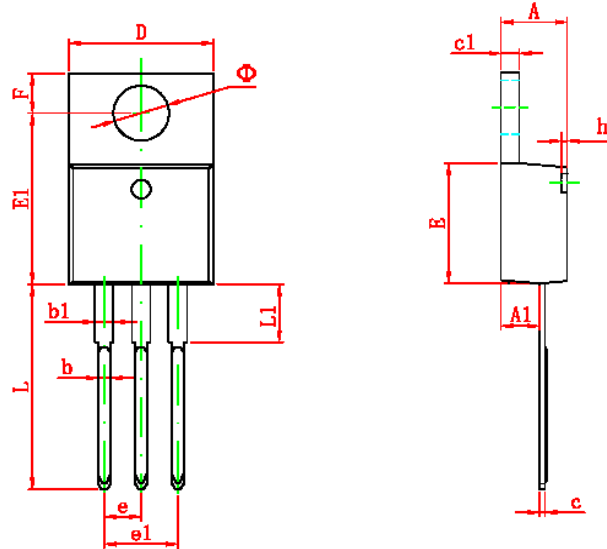

Symbol	Dimensions In Millimeters		Dimensions In Inches	
	Min	Max	Min	Max
A	4.470	4.670	0.176	0.184
A1	2.520	2.820	0.099	0.111
b	0.710	0.910	0.028	0.036
b1	1.170	1.370	0.046	0.054
c	0.310	0.530	0.012	0.021
c1	1.170	1.370	0.046	0.054
D	10.010	10.310	0.394	0.406
E	8.500	8.900	0.335	0.350
E1	12.060	12.460	0.475	0.491
e	2.540 TYP		0.100 TYP	
e1	4.980	5.180	0.196	0.204
F	2.590	2.890	0.102	0.114
h	0.000	0.300	0.000	0.012
L	13.400	13.800	0.528	0.543
L1	3.560	3.960	0.140	0.156
• •	3.735	3.935	0.147	0.155

©2010 Alfa-MOS Technology Corp.  
 2F, No.80, Sec.1, Cheng Kung Rd., Nan Kang Dist., Taipei City 115, Taiwan (R.O.C.)  
 Tel : 886 2) 2651 3928  
 Fax : 886 2) 2786 8483  
 ©http://www.alfa-mos.com