



General Description

AFN3446, N-Channel enhancement mode MOSFET, uses Advanced Trench Technology to provide excellent $R_{DS(ON)}$, low gate charge.

These devices are particularly suited for low voltage power management, such as smart phone and notebook computer and other battery powered circuits, and low in-line power loss are needed in commercial industrial surface mount applications.

Features

- 20V/4.0A, $R_{DS(ON)}=58m\Omega@V_{GS}=4.5V$
- 20V/3.6A, $R_{DS(ON)}=68m\Omega@V_{GS}=2.5V$
- 20V/3.0A, $R_{DS(ON)}=88m\Omega@V_{GS}=1.8V$
- Super high density cell design for extremely low $R_{DS(ON)}$
- Exceptional on-resistance and maximum DC current capability
- TSOP-6 package design

Pin Description (TSOP-6)

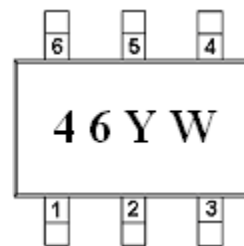
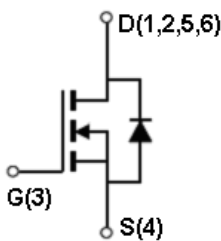
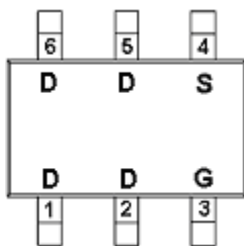

Application

- Portable Equipment
- Battery Powered System
- Net Working System

Pin Define

Pin	Symbol	Description
1	D	Drain
2	D	Drain
3	G	Gate
4	S	Source
5	D	Drain
6	D	Drain

Ordering Information

Part Ordering No.	Part Marking	Package	Unit	Quantity
AFN3446TS6RG	46YW	TSOP-6	Tape & Reel	3000 EA

- ※ 46 parts code
- ※ Y year code (0 ~ 9)
- ※ W week code (A ~ Z = 1 ~ 26 / a ~ z = 27 ~ 52)
- ※ AFN3446TS6RG : 7" Tape & Reel ; Pb- Free ; Halogen- Free



Absolute Maximum Ratings

($T_A=25^{\circ}\text{C}$ Unless otherwise noted)

Parameter	Symbol	Typical	Unit
Drain-Source Voltage	V_{DSS}	20	V
Gate –Source Voltage	V_{GSS}	± 12	V
Continuous Drain Current($T_J=150^{\circ}\text{C}$)	I_D	$T_A=25^{\circ}\text{C}$	4.0
		$T_A=70^{\circ}\text{C}$	3.0
Pulsed Drain Current	I_{DM}	20	A
Continuous Source Current(Diode Conduction)	I_S	1.6	A
Power Dissipation	P_D	$T_A=25^{\circ}\text{C}$	2.0
		$T_A=70^{\circ}\text{C}$	1.3
Operating Junction Temperature	T_J	150	$^{\circ}\text{C}$
Storage Temperature Range	T_{STG}	-55/150	$^{\circ}\text{C}$
Thermal Resistance-Junction to Ambient	$R_{\theta JA}$	120	$^{\circ}\text{C/W}$

Electrical Characteristics

($T_A=25^{\circ}\text{C}$ Unless otherwise noted)

Parameter	Symbol	Conditions	Min.	Typ	Max.	Unit
Static						
Drain-Source Breakdown Voltage	$V_{(BR)DSS}$	$V_{GS}=0V, I_D=250\mu A$	20			V
Gate Threshold Voltage	$V_{GS(th)}$	$V_{DS}=V_{GS}, I_D=250\mu A$	0.3		0.8	
Gate Leakage Current	I_{GSS}	$V_{DS}=0V, V_{GS}=\pm 12V$			± 100	nA
Zero Gate Voltage Drain Current	I_{DSS}	$V_{DS}=16V, V_{GS}=0V$			1	uA
		$V_{DS}=16V, V_{GS}=0V$ $T_J=85^{\circ}\text{C}$			10	
On-State Drain Current	$I_{D(on)}$	$V_{DS} \geq 5V, V_{GS}=4.5V$	6			A
		$V_{DS} \geq 5V, V_{GS}=2.5V$	4			
Drain-Source On-Resistance	$R_{DS(on)}$	$V_{GS}=4.5V, I_D=4.0A$		46	58	m Ω
		$V_{GS}=2.5V, I_D=3.6A$		56	68	
		$V_{GS}=1.8V, I_D=3.0A$		72	88	
Forward Transconductance	g_{FS}	$V_{DS}=5V, I_D=3.6A$		10		S
Diode Forward Voltage	V_{SD}	$I_S=1.6A, V_{GS}=0V$		0.85	1.2	V
Dynamic						
Total Gate Charge	Q_g	$V_{DS}=10V, V_{GS}=4.5V$ $I_D=3.6A$		4.2	5.0	nC
Gate-Source Charge	Q_{gs}			0.6		
Gate-Drain Charge	Q_{gd}			0.4		
Input Capacitance	C_{iss}	$V_{DS}=10V, V_{GS}=0V$ $f=1\text{MHz}$		340		pF
Output Capacitance	C_{oss}			115		
Reverse Transfer Capacitance	C_{rss}			33		
Turn-On Time	$t_{d(on)}$	$V_{DD}=10V, R_L=2.8\Omega$ $I_D=3.6A, V_{GEN}=4.5V$ $R_G=1\Omega$		8	15	ns
	t_r			8	15	
Turn-Off Time	$t_{d(off)}$			25	40	
	t_f			8	15	



Typical Characteristics

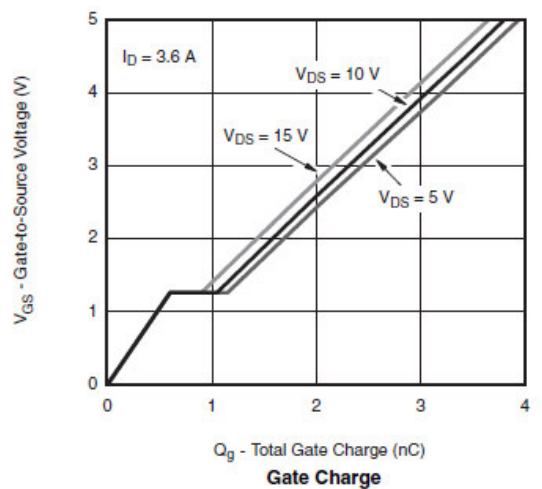
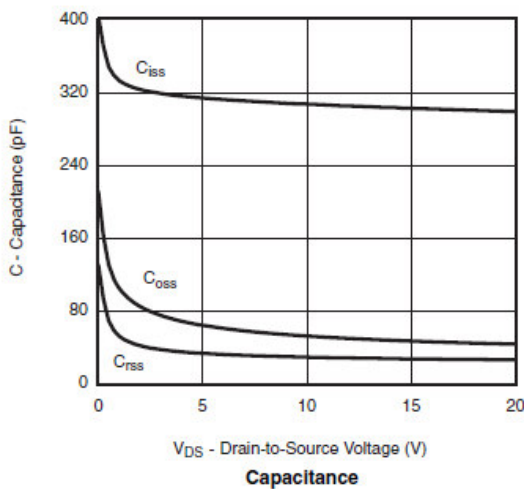
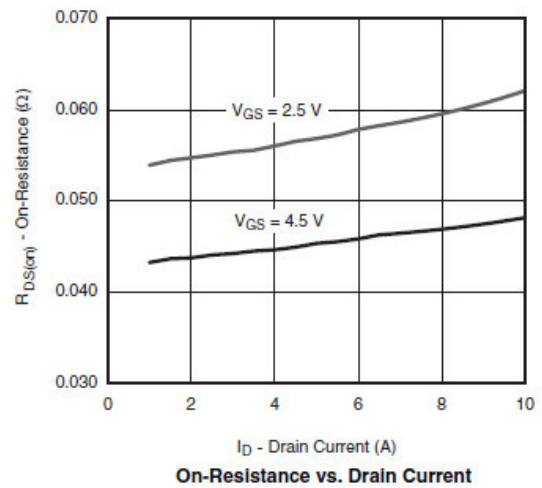
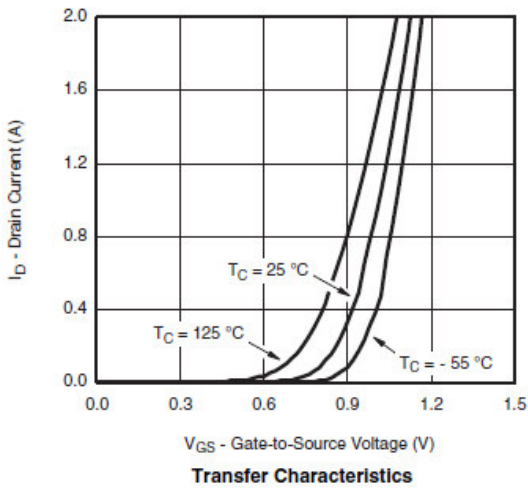
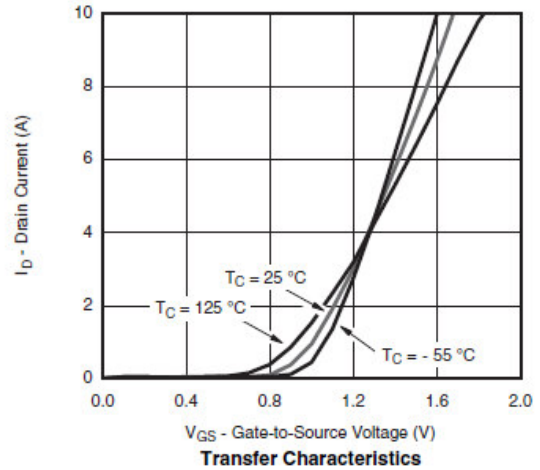
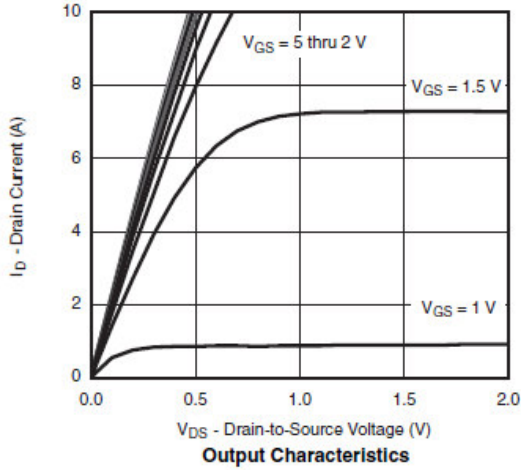



Typical Characteristics

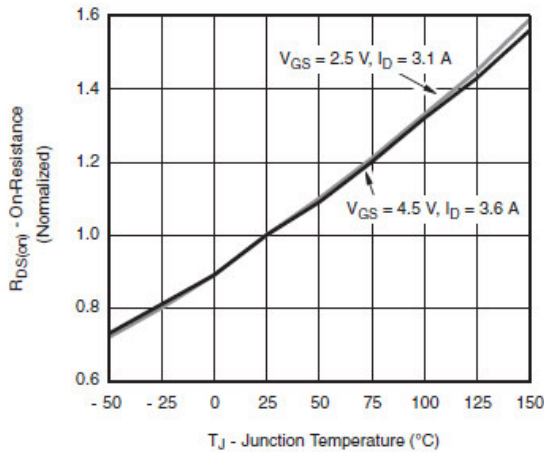

On-Resistance vs. Junction Temperature

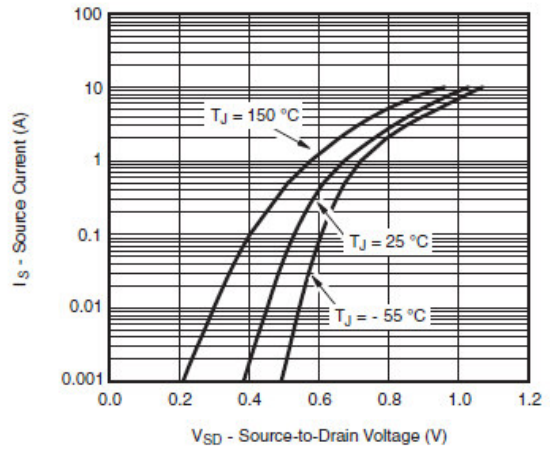

Source-Drain Diode Forward Voltage

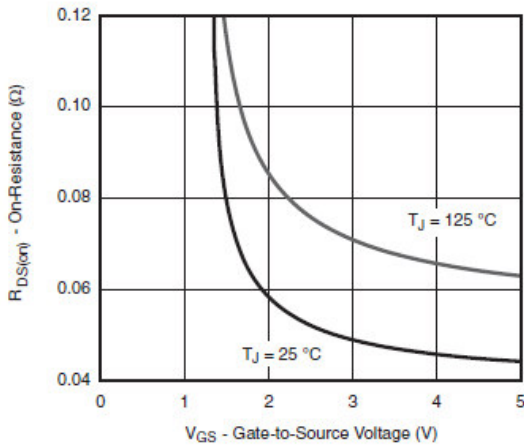

On-Resistance vs. Gate-to-Source Voltage

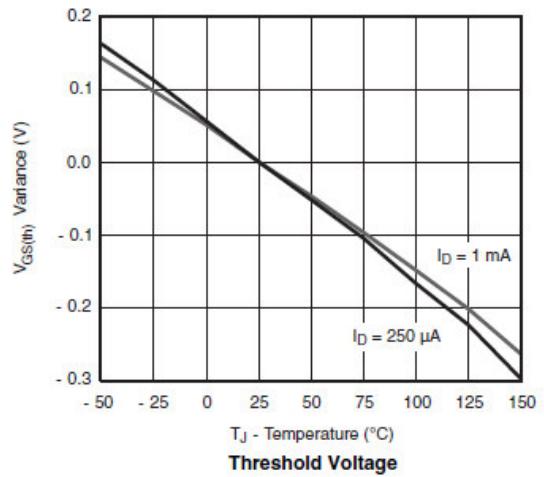

Threshold Voltage

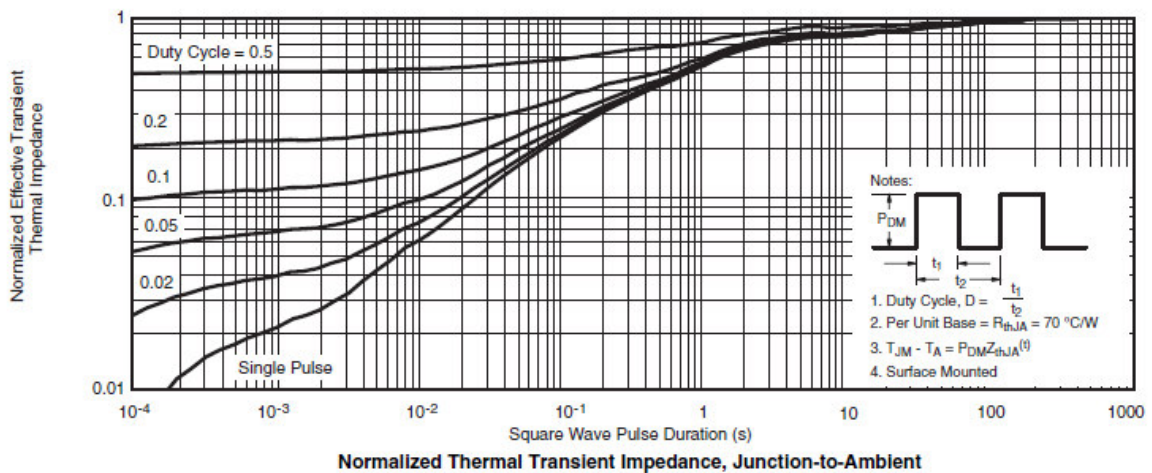

Normalized Thermal Transient Impedance, Junction-to-Ambient



Typical Characteristics

Gate Charge Test Circuit & Waveform



Resistive Switching Test Circuit & Waveforms



Unclamped Inductive Switching Test Circuit & Waveforms

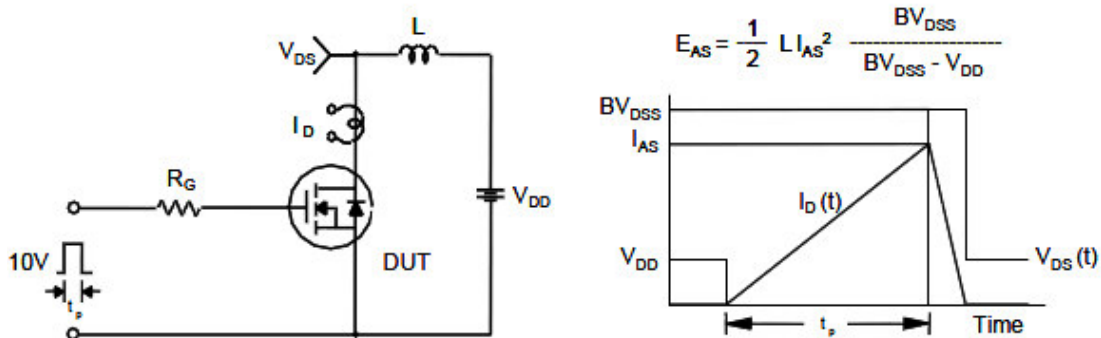



Package Information (TSOP-6)

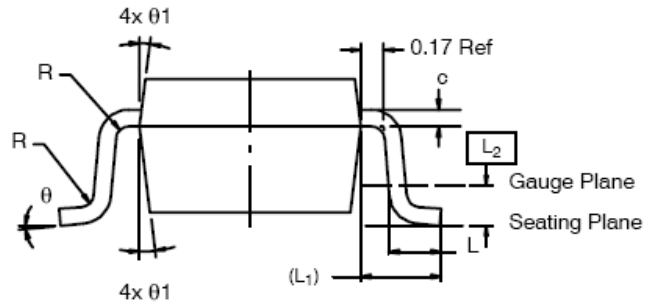
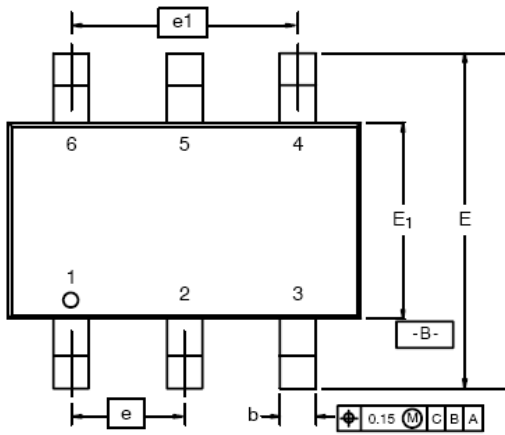

Dim	MILLIMETERS			INCHES		
	Min	Nom	Max	Min	Nom	Max
A	0.91	-	1.10	0.036	-	0.043
A ₁	0.01	-	0.10	0.0004	-	0.004
A ₂	0.90	-	1.00	0.035	0.038	0.039
b	0.30	0.32	0.45	0.012	0.013	0.018
c	0.10	0.15	0.20	0.004	0.006	0.008
D	2.95	3.05	3.10	0.116	0.120	0.122
E	2.70	2.85	2.96	0.106	0.112	0.117
E ₁	1.55	1.65	1.70	0.061	0.065	0.067
e	1.00 BSC			0.0394 BSC		
e ₁	1.90	2.00	2.10	0.075	0.080	0.085
L	0.35	-	0.50	0.014	-	0.020
L ₁	0.60 Ref			0.024 Ref		
L ₂	0.25 BSC			0.010 BSC		
R	0.10	-	-	0.004	-	-
θ	0°	4°	8°	0°	4°	8°
θ ₁	7° Nom			7° Nom		

©2010 Alfa-MOS Technology Corp.
 2F, No.80, Sec.1, Cheng Kung Rd., Nan Kang Dist., Taipei City 115, Taiwan (R.O.C.)
 Tel : 886 2) 2651 3928
 Fax : 886 2) 2786 8483
 ©http://www.alfa-mos.com