



### General Description

AFN3406AS, N-Channel enhancement mode MOSFET, uses Advanced Trench Technology to provide excellent  $R_{DS(ON)}$ , low gate charge.

These devices are particularly suited for low voltage power management, and low in-line power loss are needed in commercial industrial surface mount applications.

### Features

- 30V/2.8A,  $R_{DS(ON)}=45m\Omega@V_{GS}=10V$
- 30V/2.4A,  $R_{DS(ON)}=55m\Omega@V_{GS}=4.5V$
- Super high density cell design for extremely low  $R_{DS(ON)}$
- SOT-23 package design

### Pin Description ( SOT-23 )

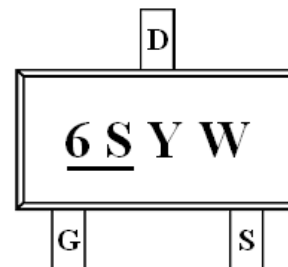
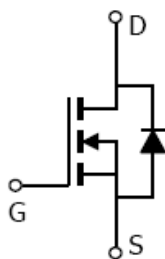
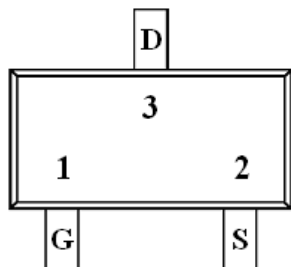

### Application

- Power Management in Note book
- LED Display
- DC-DC System
- LCD Panel

### Pin Define

Pin	Symbol	Description
1	G	Gate
2	S	Source
3	D	Drain

### Ordering Information

Part Ordering No.	Part Marking	Package	Unit	Quantity
AFN3406ASS23RG	6SYW	SOT-23	Tape & Reel	3000 EA

- ※ 6S parts code
- ※ Y year code ( 0 ~ 9 )
- ※ W week code ( A ~ Z = 1 ~ 26 / a ~ z = 27 ~ 52 )
- ※ AFN3406ASS23RG : 7" Tape & Reel ; Pb- Free ; Halogen- Free



**Absolute Maximum Ratings**

(T<sub>A</sub>=25°C Unless otherwise noted)

Parameter	Symbol	Typical	Unit
Drain-Source Voltage	V <sub>DSS</sub>	30	V
Gate –Source Voltage	V <sub>GSS</sub>	±20	V
Continuous Drain Current(T <sub>J</sub> =150°C)	I <sub>D</sub>	T <sub>A</sub> =25°C	4.0
		T <sub>A</sub> =70°C	2.4
Pulsed Drain Current	I <sub>DM</sub>	20	A
Continuous Source Current(Diode Conduction)	I <sub>S</sub>	1.5	A
Power Dissipation	P <sub>D</sub>	T <sub>A</sub> =25°C	1.25
		T <sub>A</sub> =70°C	0.8
Operating Junction Temperature	T <sub>J</sub>	150	°C
Storage Temperature Range	T <sub>STG</sub>	-55/150	°C
Thermal Resistance-Junction to Ambient	R <sub>θJA</sub>	120	°C/W

**Electrical Characteristics**

(T<sub>A</sub>=25°C Unless otherwise noted)

Parameter	Symbol	Conditions	Min.	Typ	Max.	Unit
<b>Static</b>						
Drain-Source Breakdown Voltage	V <sub>(BR)DSS</sub>	V <sub>GS</sub> =0V, I <sub>D</sub> =250uA	30			V
Gate Threshold Voltage	V <sub>GS(th)</sub>	V <sub>DS</sub> =V <sub>GS</sub> , I <sub>D</sub> =250uA	1.3		2.1	
Gate Leakage Current	I <sub>GSS</sub>	V <sub>DS</sub> =0V, V <sub>GS</sub> =±20V			±100	nA
Zero Gate Voltage Drain Current	I <sub>DSS</sub>	V <sub>DS</sub> =24V, V <sub>GS</sub> =0V			1	uA
		V <sub>DS</sub> =24V, V <sub>GS</sub> =0V T <sub>J</sub> =85°C			30	
On-State Drain Current	I <sub>D(on)</sub>	V <sub>DS</sub> ≥ 4.5V, V <sub>GS</sub> =10V	6			A
Drain-Source On-Resistance	R <sub>DS(on)</sub>	V <sub>GS</sub> =10V, I <sub>D</sub> =2.8A		32	45	mΩ
		V <sub>GS</sub> =4.5V, I <sub>D</sub> =2.4A		42	55	
Forward Transconductance	g <sub>FS</sub>	V <sub>DS</sub> =4.5V, I <sub>D</sub> =2.5A		8		S
Diode Forward Voltage	V <sub>SD</sub>	I <sub>S</sub> =1.6A, V <sub>GS</sub> =0V		0.8	1.2	V
<b>Dynamic</b>						
Total Gate Charge	Q <sub>g</sub>	V <sub>DS</sub> =15V, V <sub>GS</sub> =10V I <sub>D</sub> ≅2.6A		3.0	4.5	nC
Gate-Source Charge	Q <sub>gs</sub>			1.6		
Gate-Drain Charge	Q <sub>gd</sub>			0.6		
Input Capacitance	C <sub>iss</sub>	V <sub>DS</sub> =15V, V <sub>GS</sub> =0V f=1MHz		320		pF
Output Capacitance	C <sub>oss</sub>			70		
Reverse Transfer Capacitance	C <sub>rss</sub>			30		
Turn-On Time	t <sub>d(on)</sub>	V <sub>DD</sub> =15V, R <sub>L</sub> =15Ω I <sub>D</sub> ≅1.0A, V <sub>GEN</sub> =10V R <sub>G</sub> =6Ω		8	12	ns
	t <sub>r</sub>			12	18	
Turn-Off Time	t <sub>d(off)</sub>			15	30	
	t <sub>f</sub>			8	15	



## Typical Characteristics

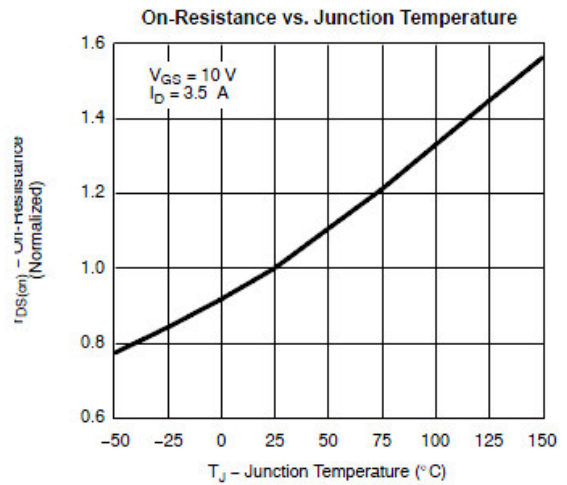
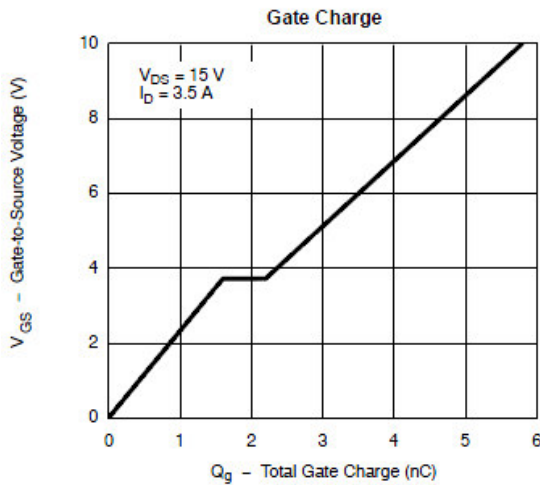
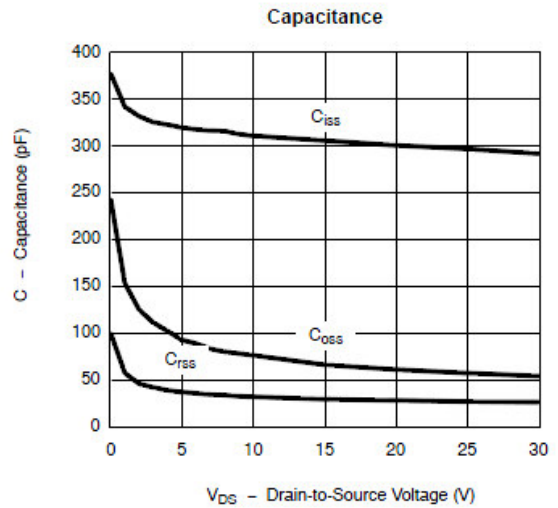
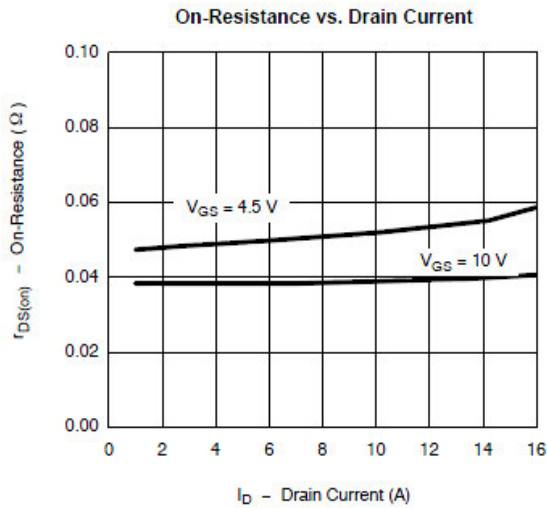
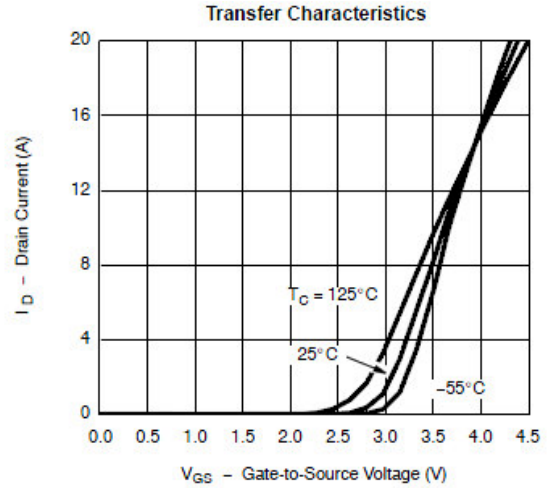
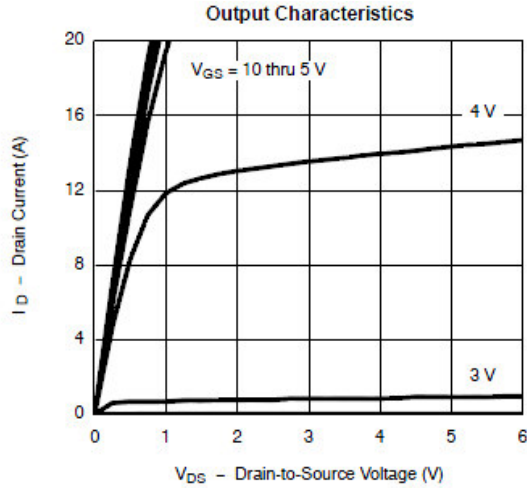



**Typical Characteristics**

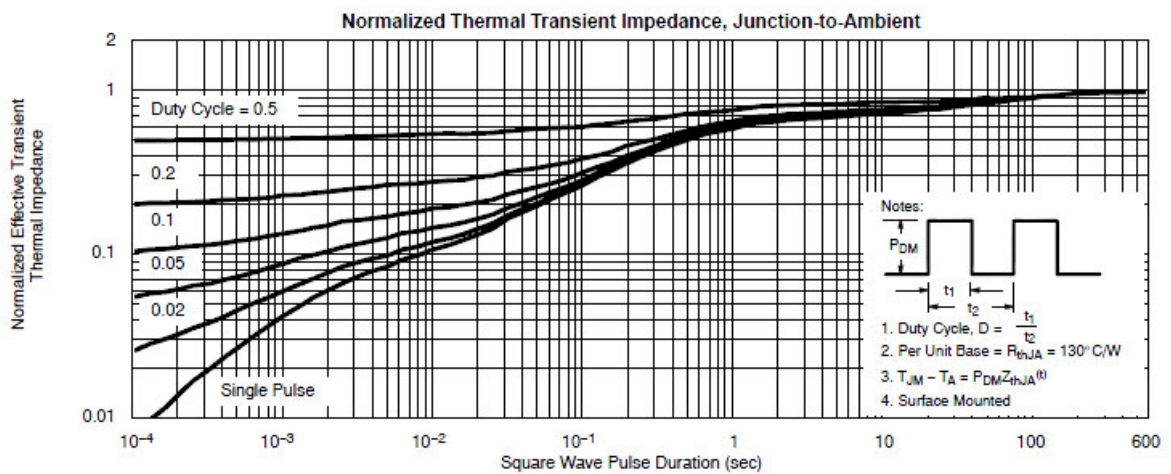
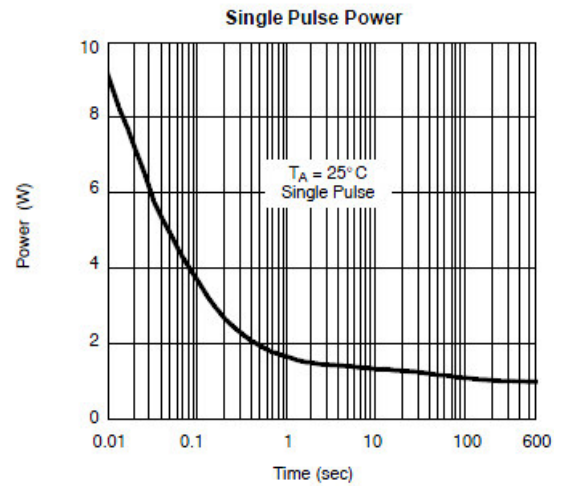
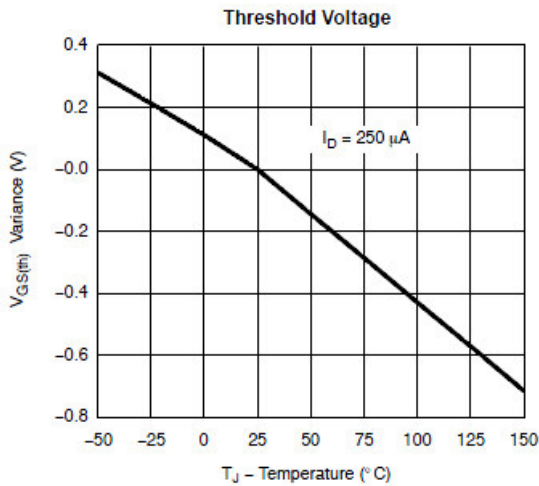
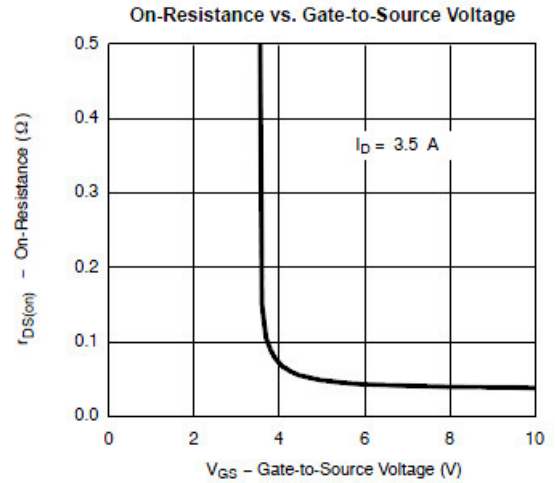
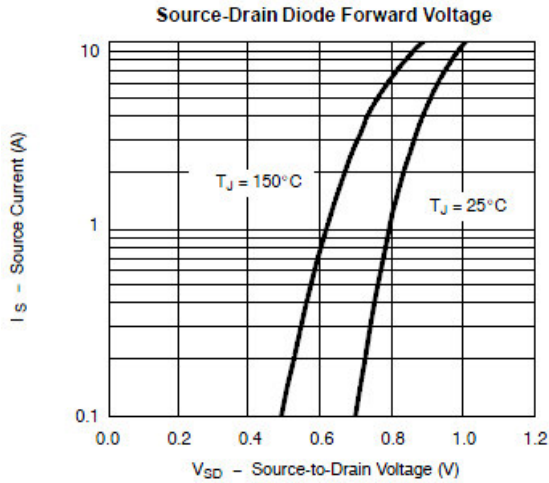



**Typical Characteristics**

Gate Charge Test Circuit & Waveform



Resistive Switching Test Circuit & Waveforms



Unclamped Inductive Switching Test Circuit & Waveforms





**Package Information ( SOT-23 )**

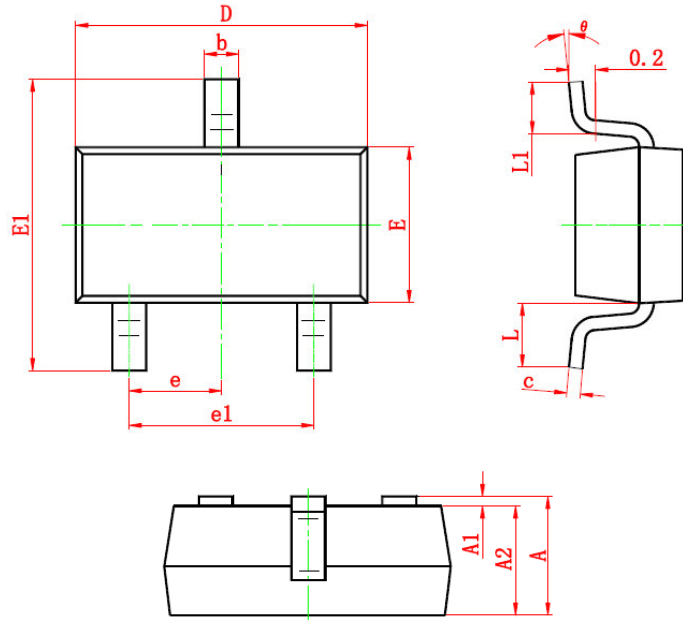

Symbol	Dimensions In Millimeters		Dimensions In Inches	
	Min	Max	Min	Max
A	0.900	1.200	0.035	0.043
A1	0.000	0.100	0.000	0.004
A2	0.900	1.100	0.035	0.039
b	0.300	0.500	0.012	0.020
c	0.080	0.150	0.003	0.006
D	2.800	3.000	0.110	0.118
E	1.200	1.400	0.047	0.055
E1	2.250	2.550	0.089	0.100
e	0.950 TYP		0.037 TYP	
e1	1.800	2.000	0.071	0.079
L	0.550 REF		0.022 REF	
L1	0.300	0.500	0.012	0.020
θ	0°	8°	0°	6°

©2010 Alfa-MOS Technology Corp.  
 2F, No.80, Sec.1, Cheng Kung Rd., Nan Kang Dist., Taipei City 115, Taiwan (R.O.C.)  
 Tel : 886 2) 2651 3928  
 Fax : 886 2) 2786 8483  
 ©http://www.alfa-mos.com