



## General Description

AFN3406, N-Channel enhancement mode MOSFET, uses Advanced Trench Technology to provide excellent  $R_{DS(ON)}$ , low gate charge.

These devices are particularly suited for low voltage power management, and low in-line power loss are needed in commercial industrial surface mount applications.

## Features

- 30V/4.0A,  $R_{DS(ON)}=42m\Omega@V_{GS}=10V$
- 30V/3.5A,  $R_{DS(ON)}=52m\Omega@V_{GS}=4.5V$
- Super high density cell design for extremely low  $R_{DS(ON)}$
- SOT-23-3L package design

## Pin Description ( SOT-23-3L )

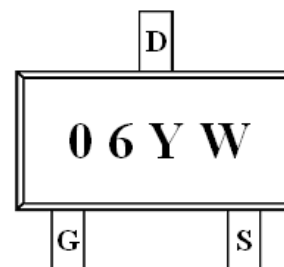
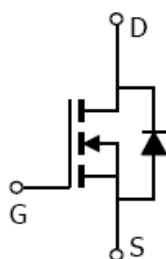
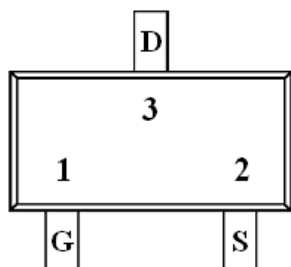

## Application

- Power Management in Note book
- LED Display
- DC-DC System
- LCD Panel

## Pin Define

| Pin | Symbol | Description |
|-----|--------|-------------|
| 1   | G      | Gate        |
| 2   | S      | Source      |
| 3   | D      | Drain       |

## Ordering Information

| Part Ordering No. | Part Marking | Package   | Unit        | Quantity |
|-------------------|--------------|-----------|-------------|----------|
| AFN3406S23RG      | 06YW         | SOT-23-3L | Tape & Reel | 3000 EA  |

- ※ 06 parts code
- ※ Y year code ( 0 ~ 9 )
- ※ W week code ( A ~ Z = 1 ~ 26 / a ~ z = 27 ~ 52 )
- ※ AFN3406S23RG : 7" Tape & Reel ; Pb- Free ; Halogen- Free



**Absolute Maximum Ratings**

(T<sub>A</sub>=25°C Unless otherwise noted)

| Parameter                                       | Symbol           | Typical              | Unit |
|---|------------------|----------------------|------|
| Drain-Source Voltage                            | V <sub>DSS</sub> | 30                   | V    |
| Gate –Source Voltage                            | V <sub>GSS</sub> | ±20                  | V    |
| Continuous Drain Current(T <sub>J</sub> =150°C) | I <sub>D</sub>   | T <sub>A</sub> =25°C | 4.0  |
|   |                  | T <sub>A</sub> =70°C | 3.5  |
| Pulsed Drain Current                            | I <sub>DM</sub>  | 20                   | A    |
| Continuous Source Current(Diode Conduction)     | I <sub>S</sub>   | 1.5                  | A    |
| Power Dissipation                               | P <sub>D</sub>   | T <sub>A</sub> =25°C | 1.25 |
|   |                  | T <sub>A</sub> =70°C | 0.8  |
| Operating Junction Temperature                  | T <sub>J</sub>   | 150                  | °C   |
| Storage Temperature Range                       | T <sub>STG</sub> | -55/150              | °C   |
| Thermal Resistance-Junction to Ambient          | R <sub>θJA</sub> | 120                  | °C/W |

**Electrical Characteristics**

(T<sub>A</sub>=25°C Unless otherwise noted)

| Parameter                       | Symbol               | Conditions   | Min. | Typ | Max. | Unit |
|---------------------------------|----------------------|--|------|-----|------|------|
| <b>Static</b>                   |                      |  |      |     |      |      |
| Drain-Source Breakdown Voltage  | V <sub>(BR)DSS</sub> | V <sub>GS</sub> =0V, I <sub>D</sub> =250uA   | 30   |     |      | V    |
| Gate Threshold Voltage          | V <sub>GS(th)</sub>  | V <sub>DS</sub> =V <sub>GS</sub> , I <sub>D</sub> =250uA   | 1.0  |     | 2.0  |      |
| Gate Leakage Current            | I <sub>GSS</sub>     | V <sub>DS</sub> =0V, V <sub>GS</sub> =±20V   |      |     | ±100 | nA   |
| Zero Gate Voltage Drain Current | I <sub>DSS</sub>     | V <sub>DS</sub> =24V, V <sub>GS</sub> =0V  |      |     | 1    | uA   |
|                                 |                      | V <sub>DS</sub> =24V, V <sub>GS</sub> =0V<br>T <sub>J</sub> =85°C  |      |     | 30   |      |
| On-State Drain Current          | I <sub>D(on)</sub>   | V <sub>DS</sub> ≥ 4.5V, V <sub>GS</sub> =10V   | 6    |     |      | A    |
| Drain-Source On-Resistance      | R <sub>DS(on)</sub>  | V <sub>GS</sub> =10V, I <sub>D</sub> =4.0A   |      | 35  | 42   | mΩ   |
|                                 |                      | V <sub>GS</sub> =4.5V, I <sub>D</sub> =3.5A  |      | 46  | 52   |      |
| Forward Transconductance        | g <sub>FS</sub>      | V <sub>DS</sub> =4.5V, I <sub>D</sub> =2.5A  |      | 8   |      | S    |
| Diode Forward Voltage           | V <sub>SD</sub>      | I <sub>S</sub> =1.6A, V <sub>GS</sub> =0V  |      | 0.8 | 1.2  | V    |
| <b>Dynamic</b>                  |                      |  |      |     |      |      |
| Total Gate Charge               | Q <sub>g</sub>       | V <sub>DS</sub> =15V, V <sub>GS</sub> =10V<br>I <sub>D</sub> ≅2.6A   |      | 3.0 | 4.5  | nC   |
| Gate-Source Charge              | Q <sub>gs</sub>      |  |      | 1.6 |      |      |
| Gate-Drain Charge               | Q <sub>gd</sub>      |  |      | 0.6 |      |      |
| Input Capacitance               | C <sub>iss</sub>     | V <sub>DS</sub> =15V, V <sub>GS</sub> =0V<br>f=1MHz  |      | 320 |      | pF   |
| Output Capacitance              | C <sub>oss</sub>     |  |      | 70  |      |      |
| Reverse Transfer Capacitance    | C <sub>rss</sub>     |  |      | 30  |      |      |
| Turn-On Time                    | t <sub>d(on)</sub>   | V <sub>DD</sub> =15V, R <sub>L</sub> =15Ω<br>I <sub>D</sub> ≅1.0A, V <sub>GEN</sub> =10V<br>R <sub>G</sub> =6Ω |      | 8   | 12   | ns   |
|                                 | t <sub>r</sub>       |  |      | 12  | 18   |      |
| Turn-Off Time                   | t <sub>d(off)</sub>  |  |      | 15  | 30   |      |
|                                 | t <sub>f</sub>       |  |      | 8   | 15   |      |



## Typical Characteristics

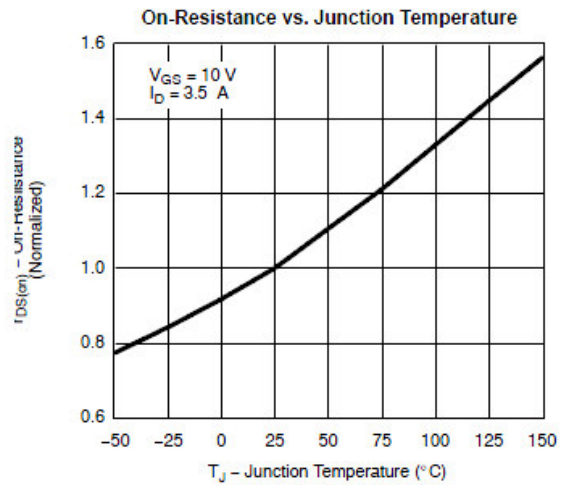
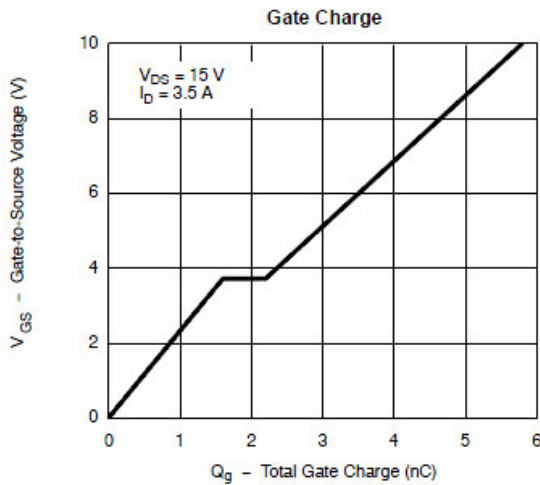
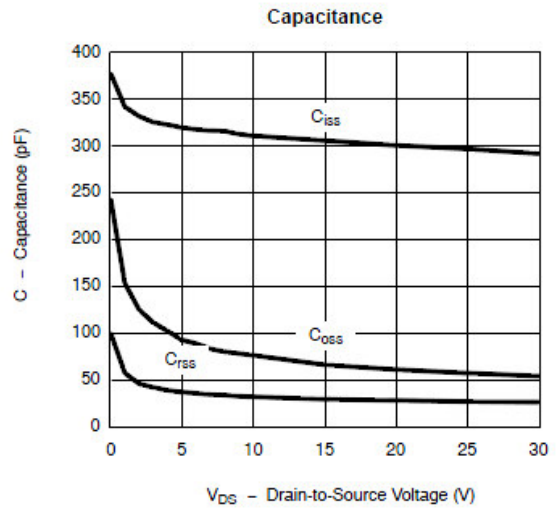
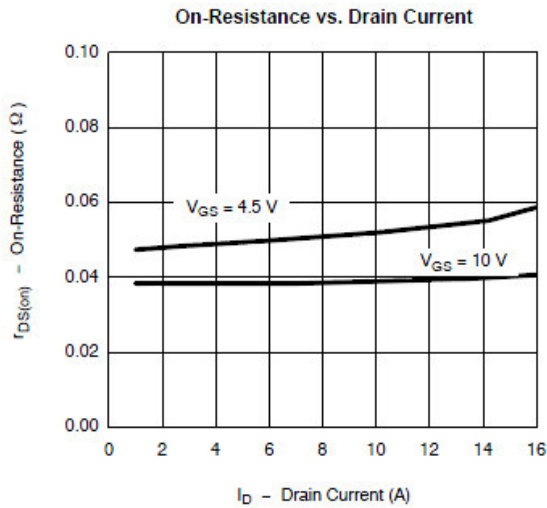
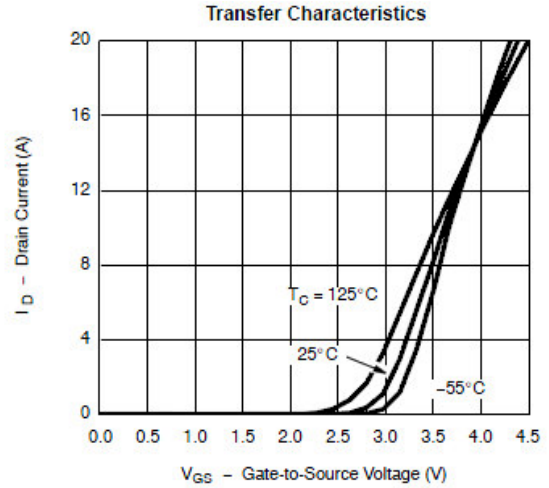
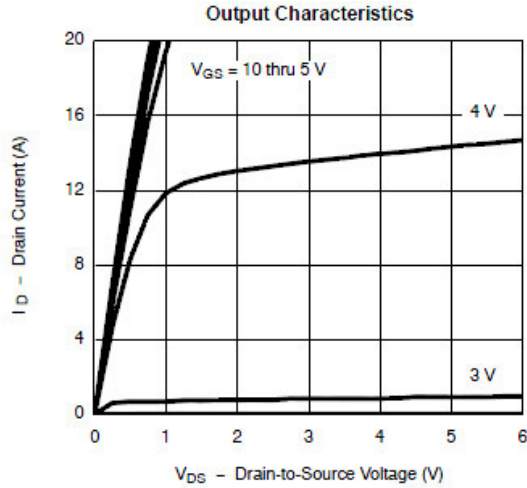



## Typical Characteristics

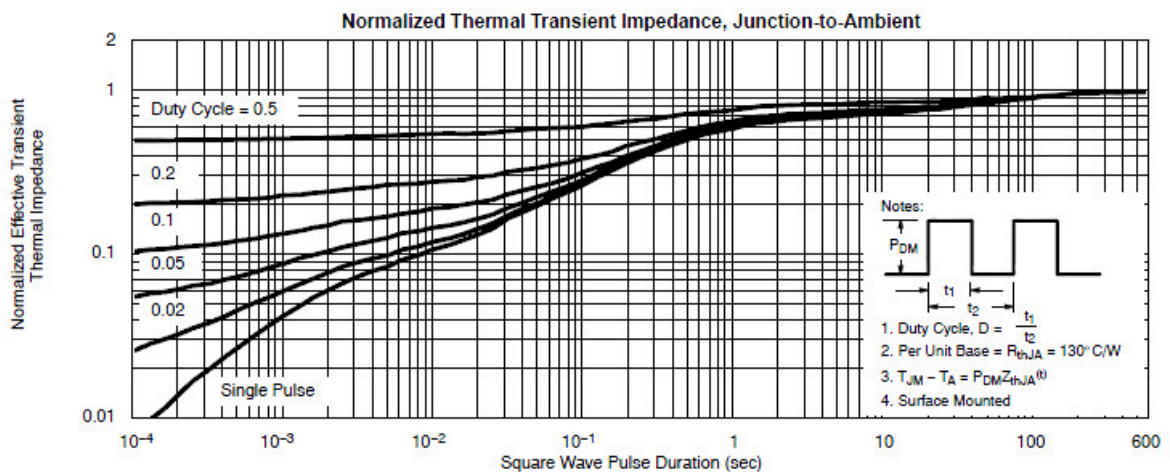
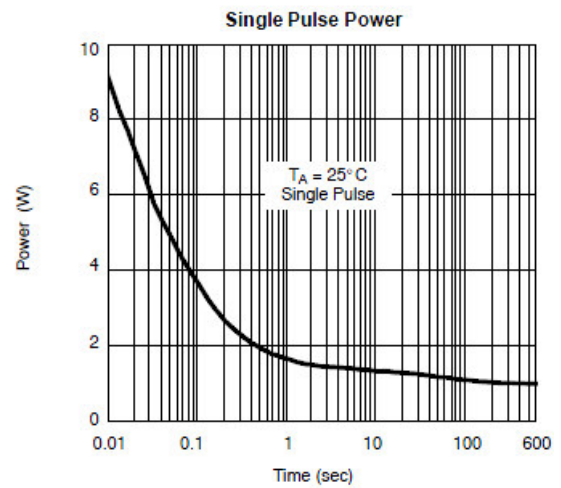
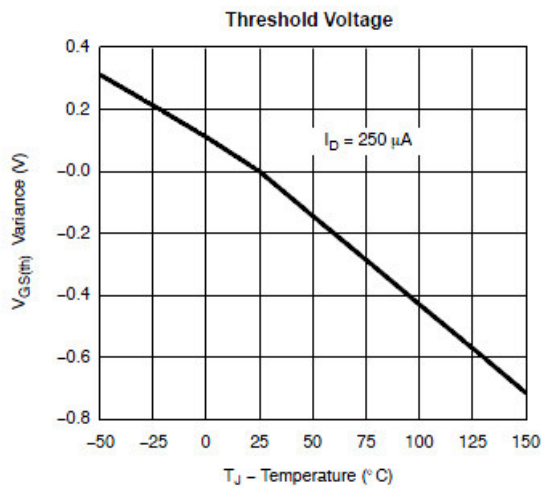
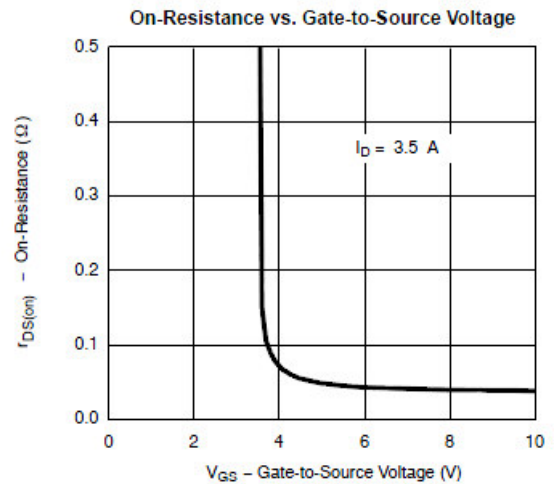
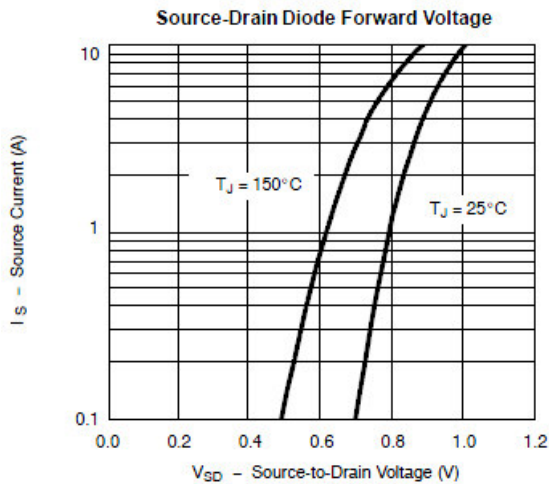



**Typical Characteristics**

Gate Charge Test Circuit & Waveform



Resistive Switching Test Circuit & Waveforms



Unclamped Inductive Switching Test Circuit & Waveforms





**Package Information ( SOT-23-3L )**

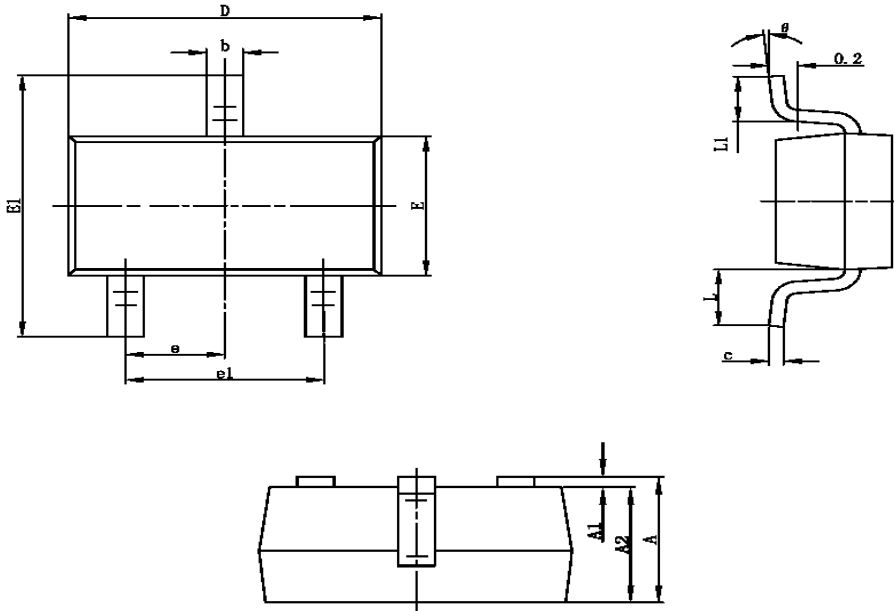

| Symbol | Dimensions In Millimeters |       | Dimensions In Inches |       |
|--------|---------------------------|-------|----------------------|-------|
|        | Min                       | Max   | Min                  | Max   |
| A      | 1.050                     | 1.250 | 0.041                | 0.049 |
| A1     | 0.000                     | 0.100 | 0.000                | 0.004 |
| A2     | 1.050                     | 1.150 | 0.041                | 0.045 |
| b      | 0.300                     | 0.400 | 0.012                | 0.016 |
| c      | 0.100                     | 0.200 | 0.004                | 0.008 |
| D      | 2.820                     | 3.020 | 0.111                | 0.119 |
| E      | 1.500                     | 1.700 | 0.059                | 0.067 |
| E1     | 2.650                     | 2.950 | 0.104                | 0.116 |
| e      | 0.950TYP                  |       | 0.037TYP             |       |
| e1     | 1.800                     | 2.000 | 0.071                | 0.079 |
| L      | 0.700REF                  |       | 0.028REF             |       |
| L1     | 0.300                     | 0.600 | 0.012                | 0.024 |
| θ      | 0°                        | 8°    | 0°                   | 8°    |

©2010 Alfa-MOS Technology Corp.  
 2F, No.80, Sec.1, Cheng Kung Rd., Nan Kang Dist., Taipei City 115, Taiwan (R.O.C.)  
 Tel : 886 2) 2651 3928  
 Fax : 886 2) 2786 8483  
 ©http://www.alfa-mos.com