



General Description

AFN2336A, N-Channel enhancement mode MOSFET, uses Advanced Trench Technology to provide excellent $R_{DS(ON)}$, low gate charge.

These devices are particularly suited for low voltage power management, such as smart phone and notebook computer and other battery powered circuits, and low in-line power loss are needed in commercial industrial surface mount applications.

Features

- 30V/1.8A, $R_{DS(ON)}=380m\Omega@V_{GS}=4.5V$
- 30V/1.5A, $R_{DS(ON)}=480m\Omega@V_{GS}=2.5V$
- 30V/0.5A, $R_{DS(ON)}=900m\Omega@V_{GS}=1.8V$
- Super high density cell design for extremely low $R_{DS(ON)}$
- Exceptional on-resistance and maximum DC current capability
- SOT-23 package design

Pin Description (SOT-23)

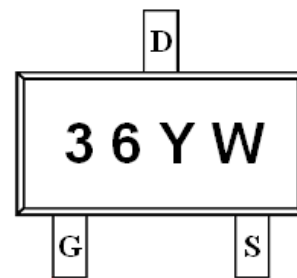
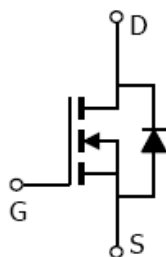
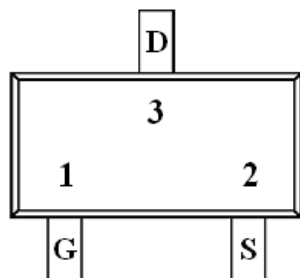

Application

- Direct Logic-Level Interface: TTL/CMOS
- Drivers: Relays, Solenoids, Lamps, Hammers
- Battery Operated Systems, DC/DC Converters
- Solid-State Relays
- Load/Power Switching-Cell Phones, Pagers

Pin Define

Pin	Symbol	Description
1	G	Gate
2	S	Source
3	D	Drain

Ordering Information

Part Ordering No.	Part Marking	Package	Unit	Quantity
AFN2336AS23RG	36YW	SOT-23	Tape & Reel	3000 EA

- ※ 36 parts code
- ※ Y year code (0 ~ 9)
- ※ W week code (A ~ Z = 1 ~ 26 / a ~ z = 27 ~ 52)
- ※ AFN2336AS23RG : 7" Tape & Reel ; Pb- Free ; Halogen- Free



Absolute Maximum Ratings

($T_A=25^{\circ}\text{C}$ Unless otherwise noted)

Parameter	Symbol	Typical	Unit
Drain-Source Voltage	V_{DSS}	30	V
Gate -Source Voltage	V_{GSS}	± 12	V
Continuous Drain Current($T_J=150^{\circ}\text{C}$)	I_D	$T_A=25^{\circ}\text{C}$	1.8
		$T_A=70^{\circ}\text{C}$	1.2
Pulsed Drain Current	I_{DM}	6	A
Continuous Source Current(Diode Conduction)	I_S	1	A
Power Dissipation	P_D	$T_A=25^{\circ}\text{C}$	1.25
		$T_A=70^{\circ}\text{C}$	0.8
Operating Junction Temperature	T_J	150	$^{\circ}\text{C}$
Storage Temperature Range	T_{STG}	-55/150	$^{\circ}\text{C}$
Thermal Resistance-Junction to Ambient	$R_{\theta JA}$	120	$^{\circ}\text{C/W}$

Electrical Characteristics

($T_A=25^{\circ}\text{C}$ Unless otherwise noted)

Parameter	Symbol	Conditions	Min.	Typ	Max.	Unit
Static						
Drain-Source Breakdown Voltage	$V_{(BR)DSS}$	$V_{GS}=0V, I_D=250\mu A$	30			V
Gate Threshold Voltage	$V_{GS(th)}$	$V_{DS}=V_{GS}, I_D=250\mu A$	0.5		1.0	V
Gate Leakage Current	I_{GSS}	$V_{DS}=0V, V_{GS}=\pm 12V$			± 100	nA
Zero Gate Voltage Drain Current	I_{DSS}	$V_{DS}=24V, V_{GS}=0V$			1	uA
		$V_{DS}=24V, V_{GS}=0V$ $T_J=85^{\circ}\text{C}$			5	
On-State Drain Current	$I_{D(on)}$	$V_{DS} \geq 5V, V_{GS}=4.5V$	1.8			A
Drain-Source On-Resistance	$R_{DS(on)}$	$V_{GS}=4.5V, I_D=1.8A$		350	380	m Ω
		$V_{GS}=2.5V, I_D=1.5A$		450	480	
		$V_{GS}=1.8V, I_D=0.5A$		850	900	
Forward Transconductance	g_{FS}	$V_{DS}=10V, I_D=1.0A$		1		S
Diode Forward Voltage	V_{SD}	$I_S=1.0A, V_{GS}=0V$		0.65	1.2	V
Dynamic						
Input Capacitance	C_{iss}	$V_{DS}=15V, V_{GS}=0V$ $f=1\text{MHz}$		85		pF
Output Capacitance	C_{oss}			25		
Reverse Transfer Capacitance	C_{rss}			15		
Total Gate Charge	Q_g	$V_{DS}=15V, V_{GS}=4.5V$ $I_D \equiv 1.2A$		1.4	1.8	nC
Gate-Source Charge	Q_{gs}			0.3		
Gate-Drain Charge	Q_{gd}			0.6		
Turn-On Time	$t_{d(on)}$	$V_{DD}=15V, R_L=20\Omega$ $I_D \equiv 1.2A, V_{GEN}=4.5V$ $R_G=1\Omega$		15	25	ns
	t_r			25	45	
Turn-Off Time	$t_{d(off)}$			15	25	
	t_f			10	20	



Typical Characteristics

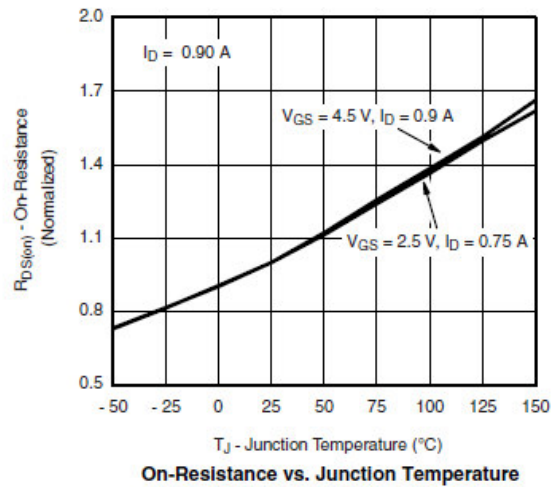
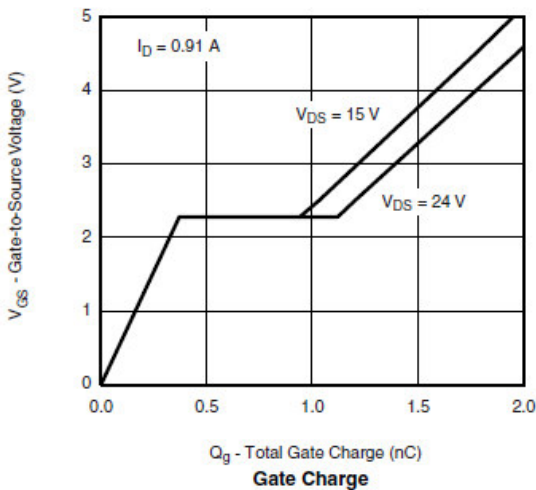
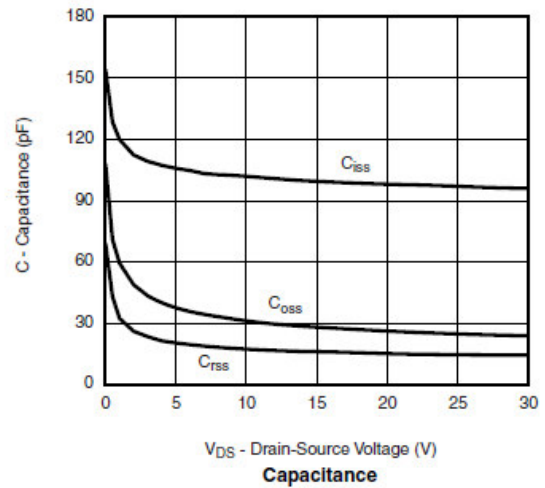
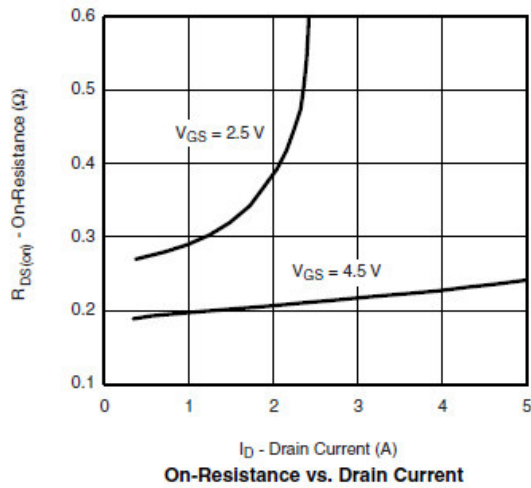
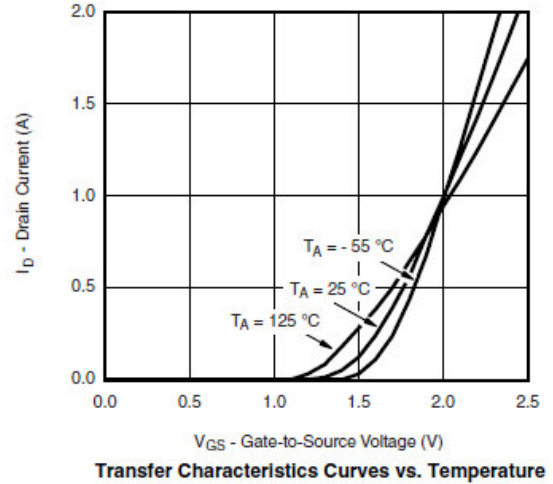
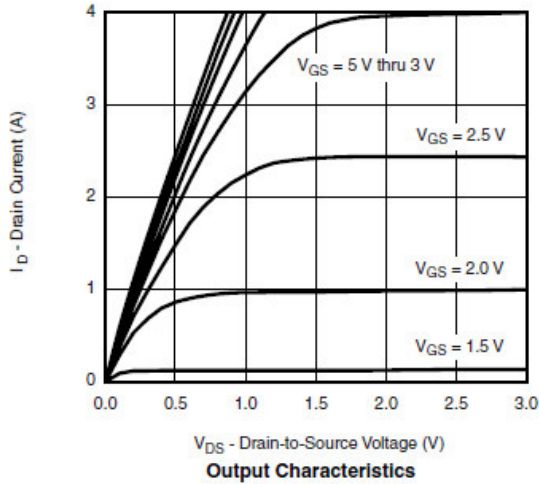



Typical Characteristics

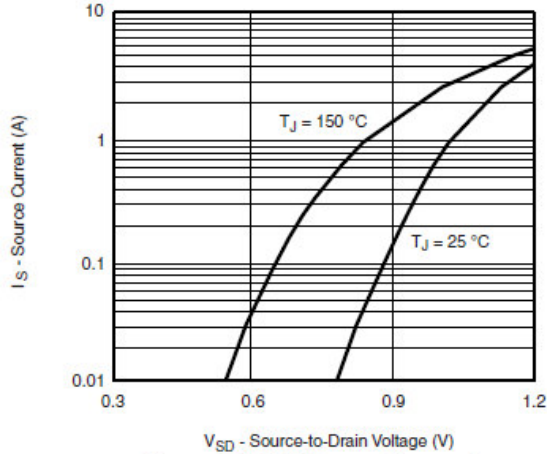

Forward Diode Voltage vs. Temperature

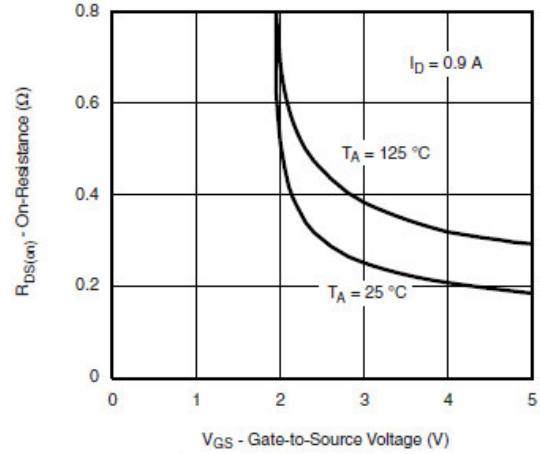

$R_{DS(on)}$ vs. V_{GS} vs. Temperature

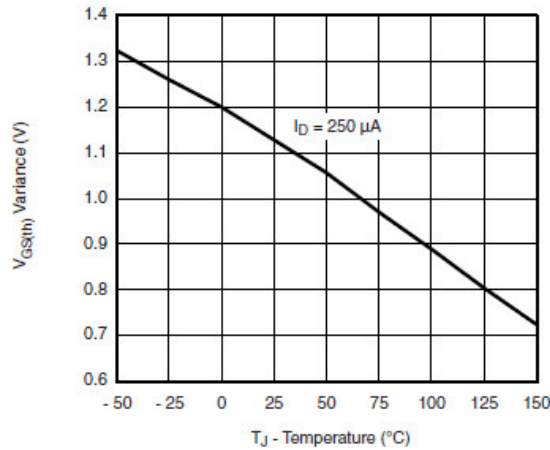

Threshold Voltage

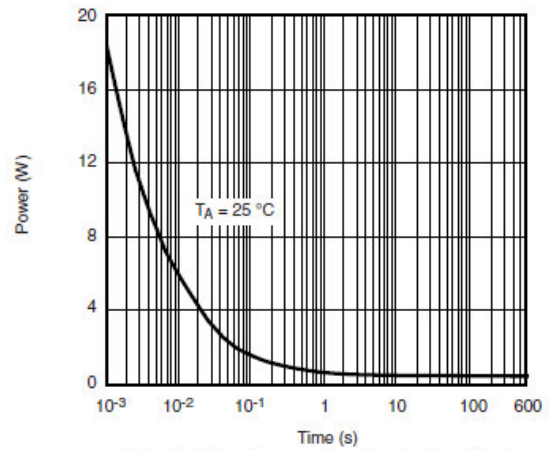

Single Pulse Power, Junction-to-Ambient

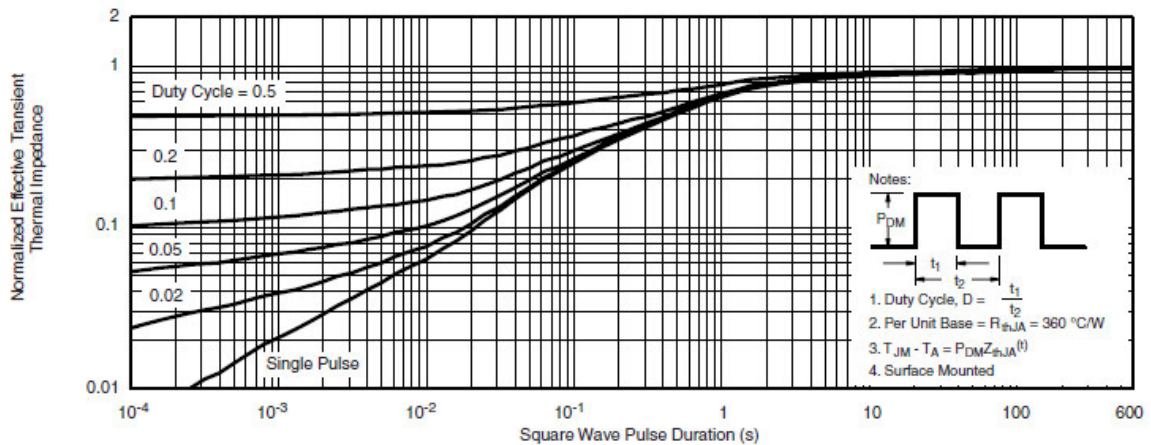

Normalized Thermal Transient Impedance, Junction-to-Ambient



Typical Characteristics

Gate Charge Test Circuit & Waveform



Resistive Switching Test Circuit & Waveforms



Unclamped Inductive Switching Test Circuit & Waveforms





Package Information (SOT-23)

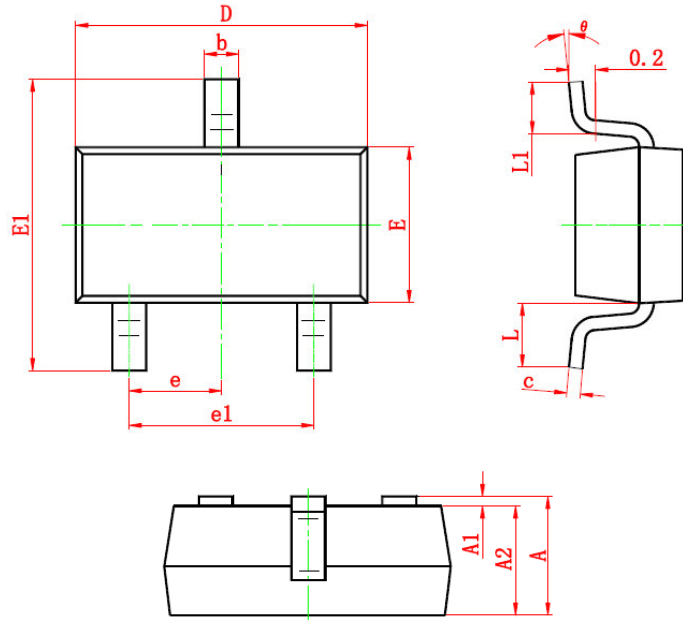

Symbol	Dimensions In Millimeters		Dimensions In Inches	
	Min	Max	Min	Max
A	0.900	1.200	0.035	0.043
A1	0.000	0.100	0.000	0.004
A2	0.900	1.100	0.035	0.039
b	0.300	0.500	0.012	0.020
c	0.080	0.150	0.003	0.006
D	2.800	3.000	0.110	0.118
E	1.200	1.400	0.047	0.055
E1	2.250	2.550	0.089	0.100
e	0.950 TYP		0.037 TYP	
e1	1.800	2.000	0.071	0.079
L	0.550 REF		0.022 REF	
L1	0.300	0.500	0.012	0.020
θ	0°	8°	0°	6°

©2010 Alfa-MOS Technology Corp.
 2F, No.80, Sec.1, Cheng Kung Rd., Nan Kang Dist., Taipei City 115, Taiwan (R.O.C.)
 Tel : 886 2) 2651 3928
 Fax : 886 2) 2786 8483
 ©http://www.alfa-mos.com