



General Description

AFN2330, N-Channel enhancement mode MOSFET, uses Advanced Trench Technology to provide excellent $R_{DS(ON)}$, low gate charge.

These devices are particularly suited for low voltage power management, such as smart phone and notebook computer and other battery powered circuits, and low in-line power loss are needed in commercial industrial surface mount applications.

Features

- 90V/2.8A, $R_{DS(ON)}=190m\Omega@V_{GS}=10V$
- 90V/2.0A, $R_{DS(ON)}=200m\Omega@V_{GS}=4.5V$
- Super high density cell design for extremely low $R_{DS(ON)}$
- Exceptional on-resistance and maximum DC current capability
- SOT-23-3L package design

Pin Description (SOT-23-3L)

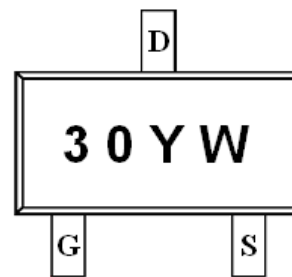
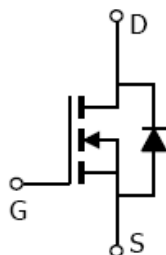
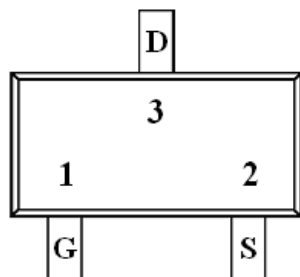

Application

- DC/DC Converters
- Load Switch
- LED Backlighting in LCD TVs

Pin Define

Pin	Symbol	Description
1	G	Gate
2	S	Source
3	D	Drain

Ordering Information

Part Ordering No.	Part Marking	Package	Unit	Quantity
AFN2330S23RG	30YW	SOT-23-3L	Tape & Reel	3000 EA

- ※ 30 parts code
- ※ Y year code (0 ~ 9)
- ※ W week code (A ~ Z = 1 ~ 26 / a ~ z = 27 ~ 52)
- ※ AFN2330S23RG : 7" Tape & Reel ; Pb- Free ; Halogen- Free



Absolute Maximum Ratings

(T_A=25°C Unless otherwise noted)

Parameter	Symbol	Typical	Unit
Drain-Source Voltage	V _{DSS}	90	V
Gate –Source Voltage	V _{GSS}	±20	V
Continuous Drain Current(T _J =150°C)	I _D	T _c =25°C	2.8
		T _c =70°C	2.0
Pulsed Drain Current	I _{DM}	6	A
Continuous Source Current(Diode Conduction)	I _S	1.6	A
Power Dissipation	P _D	T _A =25°C	1.25
		T _A =70°C	0.8
Operating Junction Temperature	T _J	150	°C
Storage Temperature Range	T _{STG}	-55/150	°C
Thermal Resistance-Junction to Ambient	R _{θJA}	120	°C/W

Electrical Characteristics

(T_A=25°C Unless otherwise noted)

Parameter	Symbol	Conditions	Min.	Typ	Max.	Unit
Static						
Drain-Source Breakdown Voltage	V _{(BR)DSS}	V _{GS} =0V, I _D =250uA	90			V
Gate Threshold Voltage	V _{GS(th)}	V _{DS} =V _{GS} , I _D =250uA	1.0		2.0	V
Gate Leakage Current	I _{GSS}	V _{DS} =0V, V _{GS} =±20V			±100	nA
Zero Gate Voltage Drain Current	I _{DSS}	V _{DS} =72V, V _{GS} =0V			1	uA
		V _{DS} =72V, V _{GS} =0V T _J =85°C			10	
On-State Drain Current	I _{D(on)}	V _{DS} ≥ 5V, V _{GS} =4.5V	6			A
Drain-Source On-Resistance	R _{DS(on)}	V _{GS} =10V, I _D =2.8A		170	190	mΩ
		V _{GS} =4.5V, I _D =2.0A		180	200	
Forward Transconductance	g _{FS}	V _{DS} =20V, I _D =1.5A		2		S
Diode Forward Voltage	V _{SD}	I _S =1.3A, V _{GS} =0V		0.85	1.2	V
Dynamic						
Total Gate Charge	Q _g	V _{DS} =50V, V _{GS} =4.5V I _D ≧1.6A		2.8	5.8	nC
Gate-Source Charge	Q _{gs}			0.75		
Gate-Drain Charge	Q _{gd}			1.4		
Input Capacitance	C _{iss}	V _{DS} =50V, V _{GS} =0V f=1MHz		200		pF
Output Capacitance	C _{oss}			22		
Reverse Transfer Capacitance	C _{rss}			13		
Turn-On Time	t _{d(on)}	V _{DD} =50V, R _L =39Ω I _D ≧1.3A, V _{GEN} =4.5V R _G =1Ω		25	50	ns
	t _r			20	50	
Turn-Off Time	t _{d(off)}			15	30	
	t _f			10	25	



Typical Characteristics

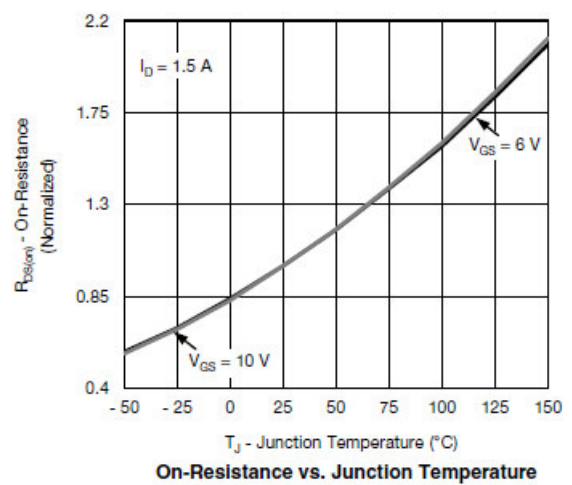
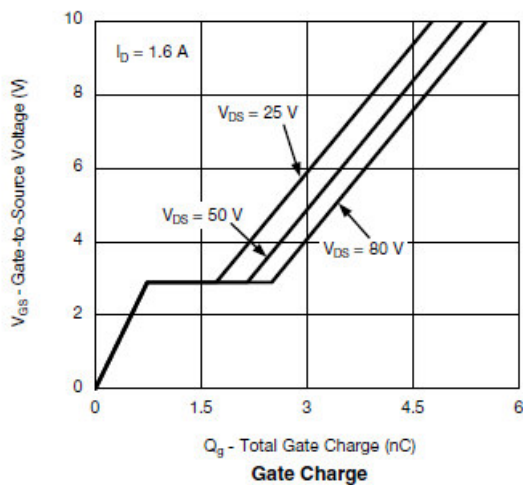
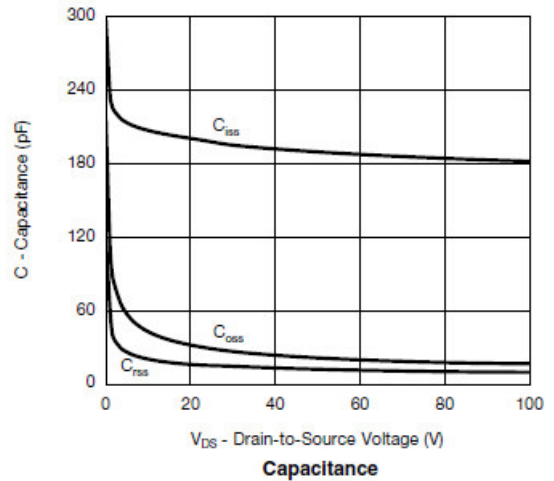
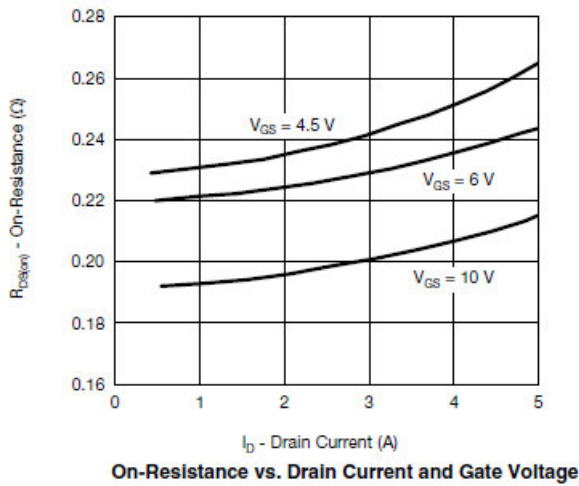
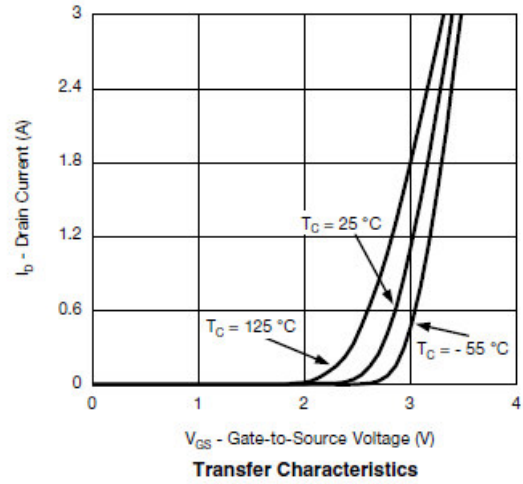
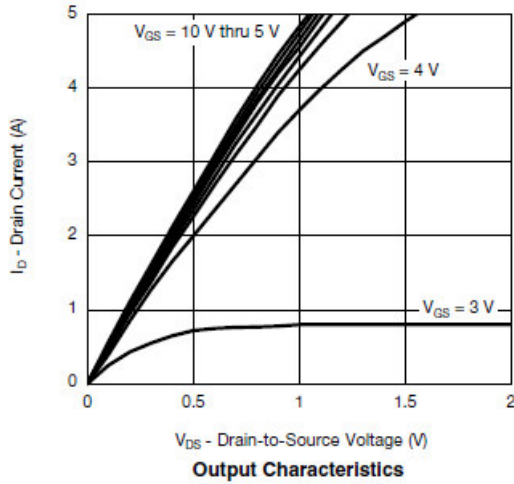



Typical Characteristics

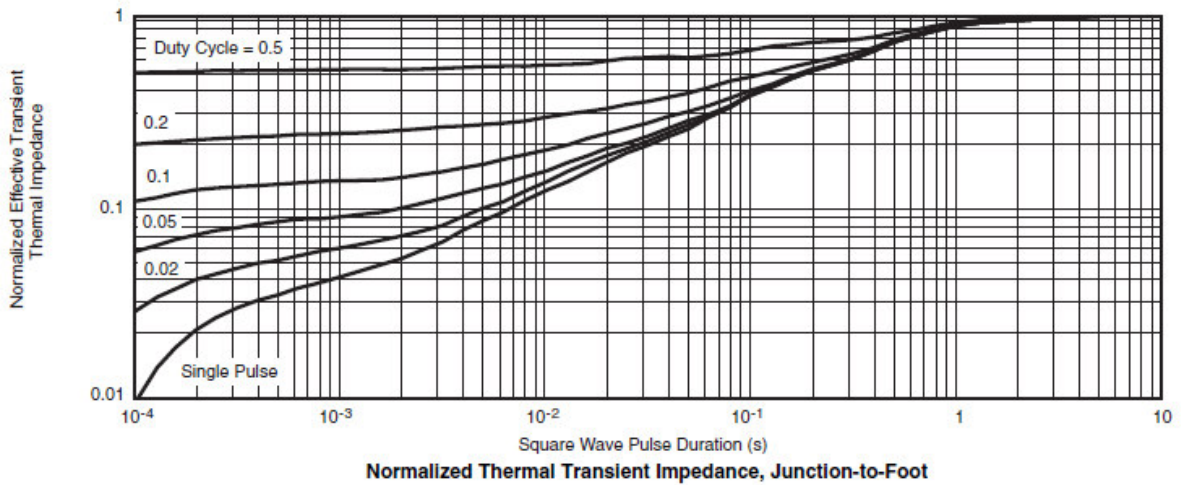
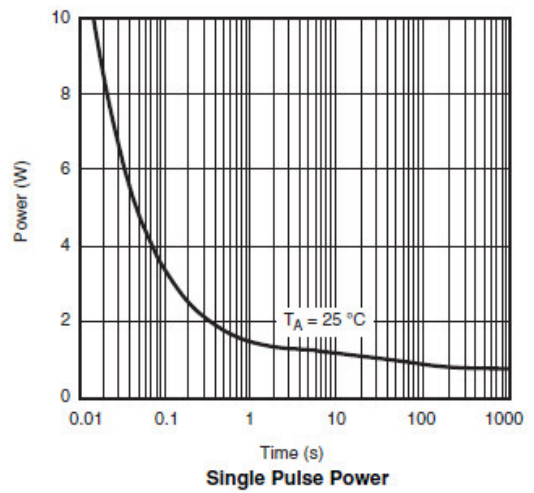
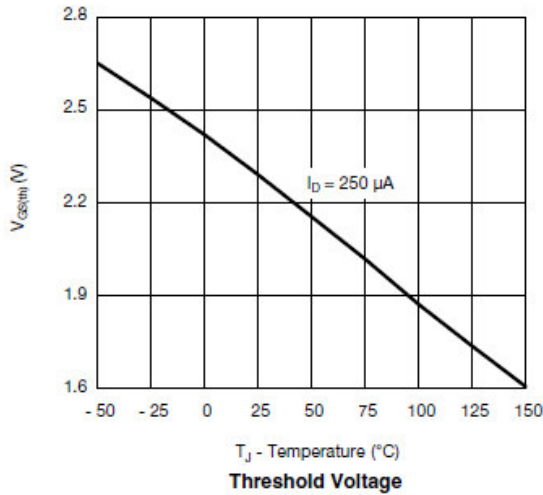
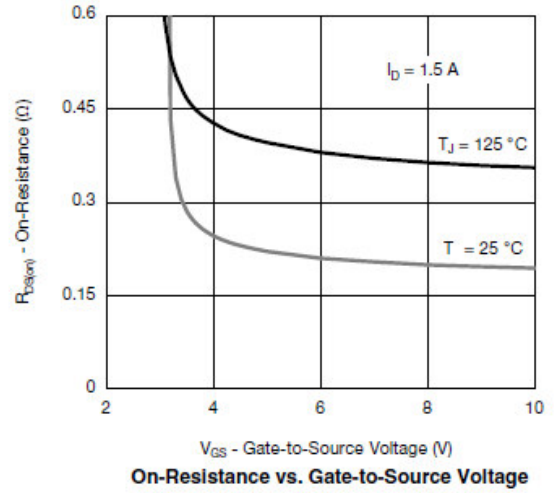
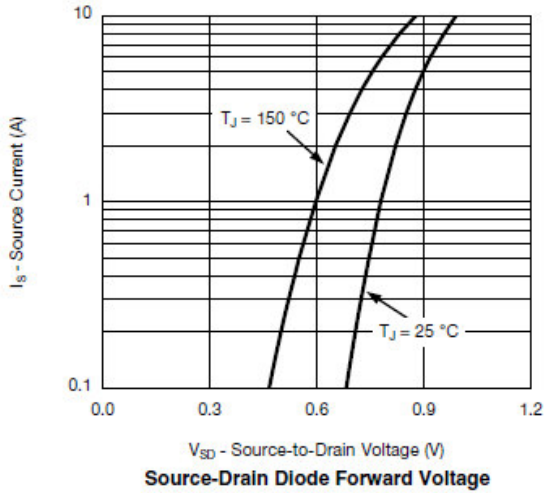



Typical Characteristics

Gate Charge Test Circuit & Waveform



Resistive Switching Test Circuit & Waveforms

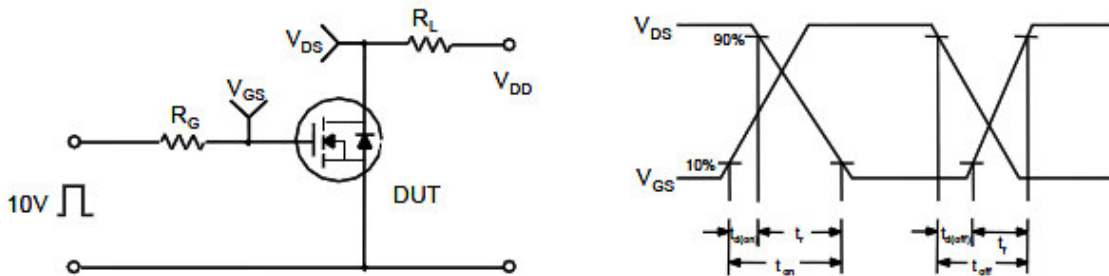

Unclamped Inductive Switching Test Circuit & Waveforms

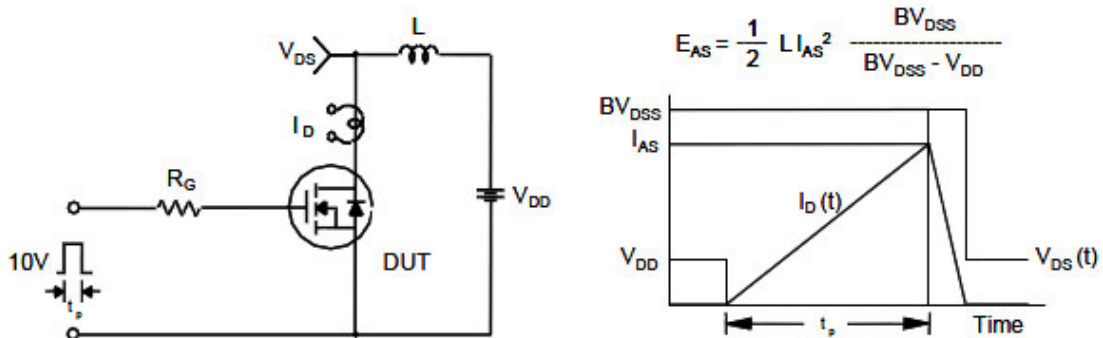



Package Information (SOT-23-3L)

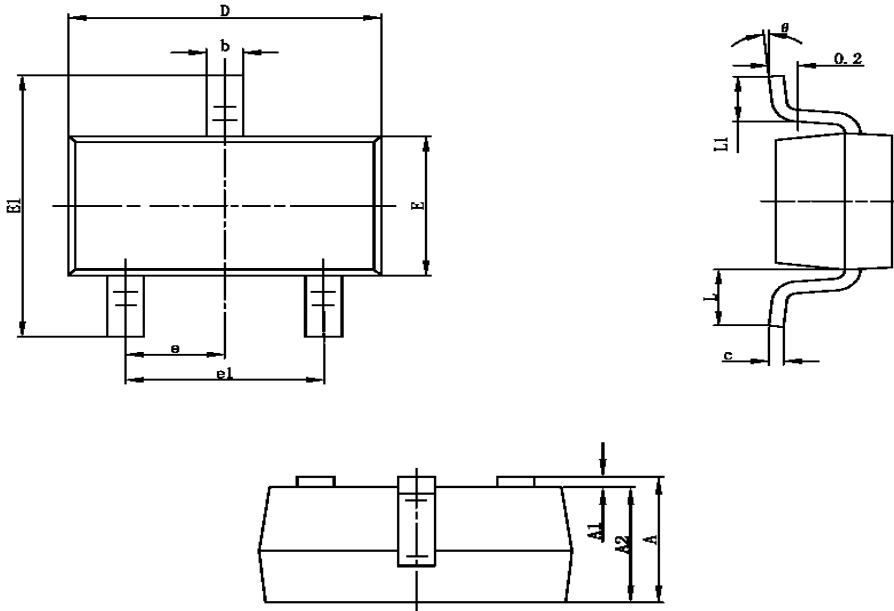

Symbol	Dimensions In Millimeters		Dimensions In Inches	
	Min	Max	Min	Max
A	1.050	1.250	0.041	0.049
A1	0.000	0.100	0.000	0.004
A2	1.050	1.150	0.041	0.045
b	0.300	0.400	0.012	0.016
c	0.100	0.200	0.004	0.008
D	2.820	3.020	0.111	0.119
E	1.500	1.700	0.059	0.067
E1	2.650	2.950	0.104	0.116
e	0.950TYP		0.037TYP	
e1	1.800	2.000	0.071	0.079
L	0.700REF		0.028REF	
L1	0.300	0.600	0.012	0.024
θ	0°	8°	0°	8°

©2010 Alfa-MOS Technology Corp.
 2F, No.80, Sec.1, Cheng Kung Rd., Nan Kang Dist., Taipei City 115, Taiwan (R.O.C.)
 Tel : 886 2) 2651 3928
 Fax : 886 2) 2786 8483
 ©http://www.alfa-mos.com