



### General Description

AFN2306AE, N-Channel enhancement mode MOSFET, uses Advanced Trench Technology to provide excellent  $R_{DS(ON)}$ , low gate charge.

These devices are particularly suited for low voltage power management, such as smart phone and notebook computer and other battery powered circuits, and low in-line power loss are needed in commercial industrial surface mount applications.

### Features

- 20V/1.8A,  $R_{DS(ON)}=280m\Omega@V_{GS}=4.5V$
- 20V/1.5A,  $R_{DS(ON)}=340m\Omega@V_{GS}=2.5V$
- 20V/1.2A,  $R_{DS(ON)}=750m\Omega@V_{GS}=1.8V$
- Super high density cell design for extremely low  $R_{DS(ON)}$
- Exceptional on-resistance and maximum DC current capability
- **ESD Protected**
- SOT-23 package design

### Pin Description ( SOT-23 )

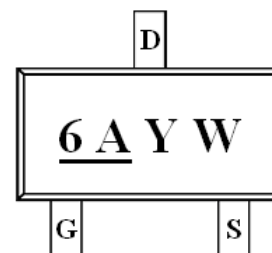
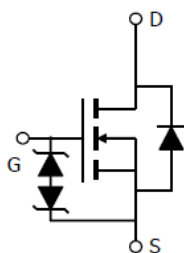
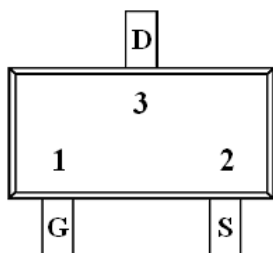

### Application

- Direct Logic-Level Interface: TTL/CMOS
- Drivers: Relays, Solenoids, Lamps, Hammers
- Battery Operated Systems, DC/DC Converters
- Solid-State Relays
- Load/Power Switching-Cell Phones, Pagers

### Pin Define

Pin	Symbol	Description
1	G	Gate
2	S	Source
3	D	Drain

### Ordering Information

Part Ordering No.	Part Marking	Package	Unit	Quantity
AFN2306AES23RG	6AYW	SOT-23	Tape & Reel	3000 EA

- ※ 6A parts code
- ※ Y year code ( 0 ~ 9 )
- ※ W week code ( A ~ Z = 1 ~ 26 / a ~ z = 27 ~ 52 )
- ※ AFN2306AES23RG : 7" Tape & Reel ; Pb- Free ; Halogen- Free



**Absolute Maximum Ratings**

(T<sub>A</sub>=25°C Unless otherwise noted)

Parameter	Symbol	Typical	Unit
Drain-Source Voltage	V <sub>DSS</sub>	20	V
Gate –Source Voltage	V <sub>GSS</sub>	±12	V
Continuous Drain Current(T <sub>J</sub> =150°C)	I <sub>D</sub>	T <sub>A</sub> =25°C	1.8
		T <sub>A</sub> =70°C	1.2
Pulsed Drain Current	I <sub>DM</sub>	6	A
Continuous Source Current(Diode Conduction)	I <sub>S</sub>	1	A
Power Dissipation	P <sub>D</sub>	T <sub>A</sub> =25°C	1.25
		T <sub>A</sub> =70°C	0.8
Operating Junction Temperature	T <sub>J</sub>	150	°C
Storage Temperature Range	T <sub>STG</sub>	-55/150	°C
Thermal Resistance-Junction to Ambient	R <sub>θJA</sub>	120	°C/W

**Electrical Characteristics**

(T<sub>A</sub>=25°C Unless otherwise noted)

Parameter	Symbol	Conditions	Min.	Typ	Max.	Unit
<b>Static</b>						
Drain-Source Breakdown Voltage	V <sub>(BR)DSS</sub>	V <sub>GS</sub> =0V, I <sub>D</sub> =250uA	20			V
Gate Threshold Voltage	V <sub>GS(th)</sub>	V <sub>DS</sub> =V <sub>GS</sub> , I <sub>D</sub> =250uA	0.3		0.8	
Gate Leakage Current	I <sub>GSS</sub>	V <sub>DS</sub> =0V, V <sub>GS</sub> =±12V			±1	mA
Zero Gate Voltage Drain Current	I <sub>DSS</sub>	V <sub>DS</sub> =16V, V <sub>GS</sub> =0V			1	uA
		V <sub>DS</sub> =16V, V <sub>GS</sub> =0V T <sub>J</sub> =85°C			5	
On-State Drain Current	I <sub>D(on)</sub>	V <sub>DS</sub> ≥ 5V, V <sub>GS</sub> =4.5V	1.8			A
Drain-Source On-Resistance	R <sub>DS(on)</sub>	V <sub>GS</sub> =4.5V, I <sub>D</sub> =1.8A		220	280	mΩ
		V <sub>GS</sub> =2.5V, I <sub>D</sub> =1.5A		260	340	
		V <sub>GS</sub> =1.8V, I <sub>D</sub> =1.2A		540	750	
Forward Transconductance	g <sub>FS</sub>	V <sub>DS</sub> =10V, I <sub>D</sub> =1.0A		1		S
Diode Forward Voltage	V <sub>SD</sub>	I <sub>S</sub> =1.0A, V <sub>GS</sub> =0V		0.65	1.2	V
<b>Dynamic</b>						
Input Capacitance	C <sub>iss</sub>	V <sub>DS</sub> =10V, V <sub>GS</sub> =0V f=1MHz		70		pF
Output Capacitance	C <sub>oss</sub>			20		
Reverse Transfer Capacitance	C <sub>rss</sub>			8		
Total Gate Charge	Q <sub>g</sub>	V <sub>DS</sub> =10V, V <sub>GS</sub> =4.5V I <sub>D</sub> ≅1.2A		1.06	1.38	nC
Gate-Source Charge	Q <sub>gs</sub>			0.18		
Gate-Drain Charge	Q <sub>gd</sub>			0.32		
Turn-On Time	t <sub>d(on)</sub>	V <sub>DD</sub> =10V, R <sub>L</sub> =20Ω I <sub>D</sub> ≅1.2A, V <sub>GEN</sub> =4.5V R <sub>G</sub> =1Ω		18	26	ns
	t <sub>r</sub>			20	28	
Turn-Off Time	t <sub>d(off)</sub>			70	110	
	t <sub>f</sub>			25	40	



## Typical Characteristics

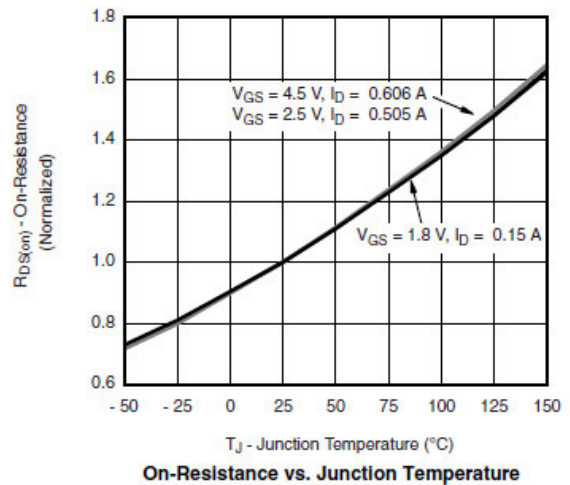
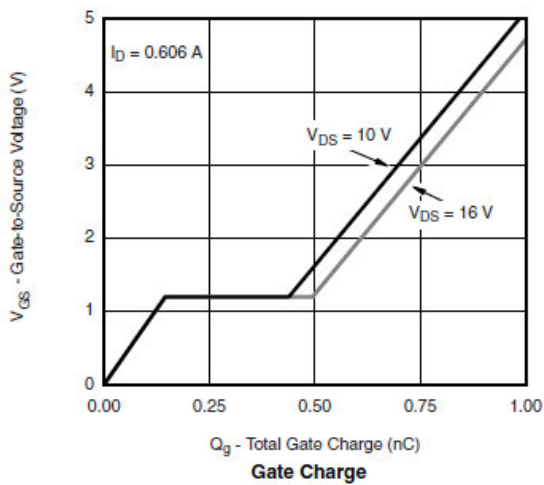
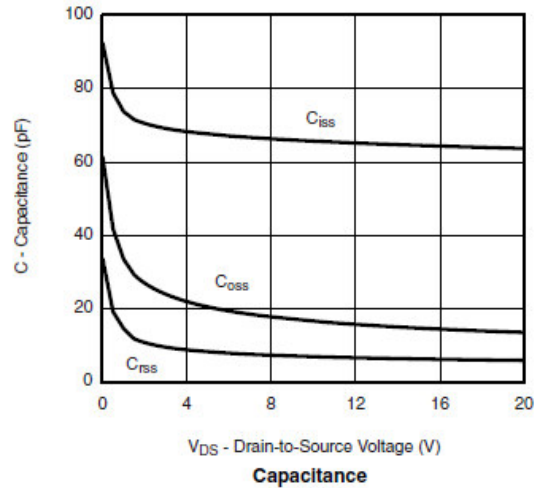
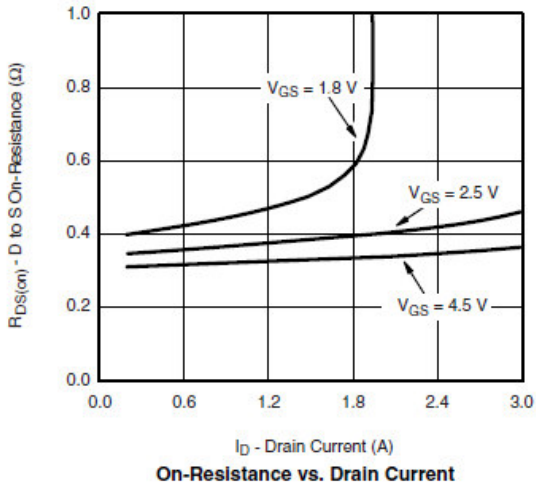
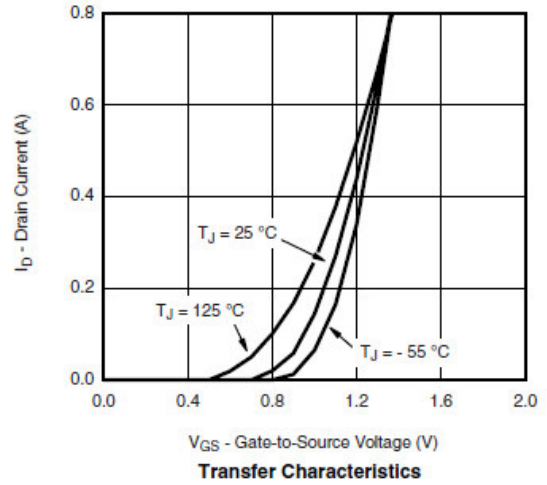
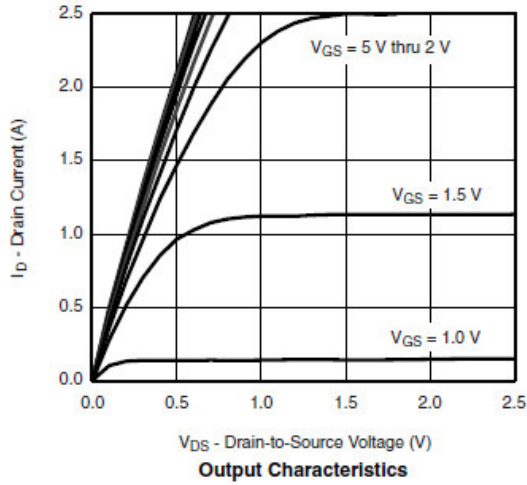



## Typical Characteristics

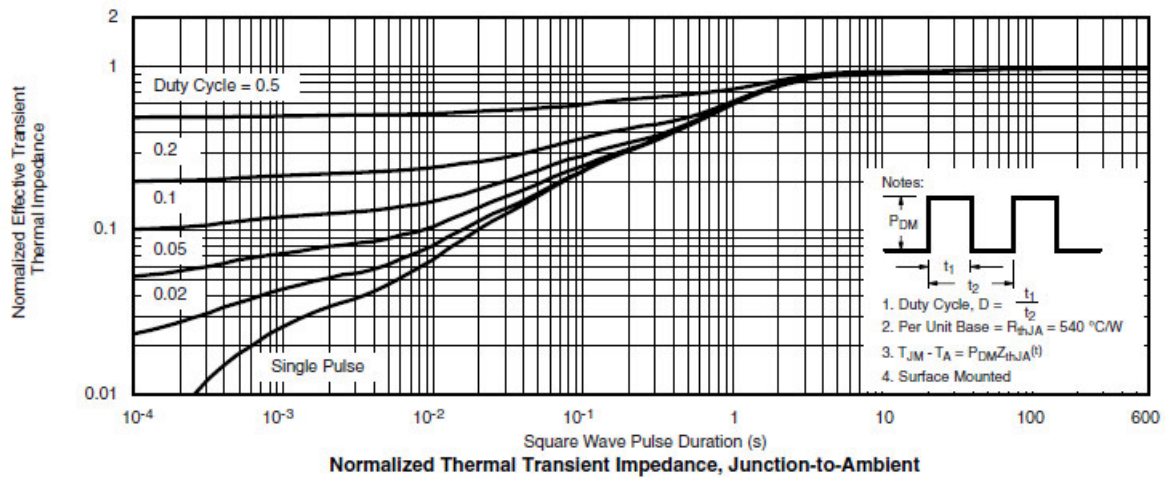
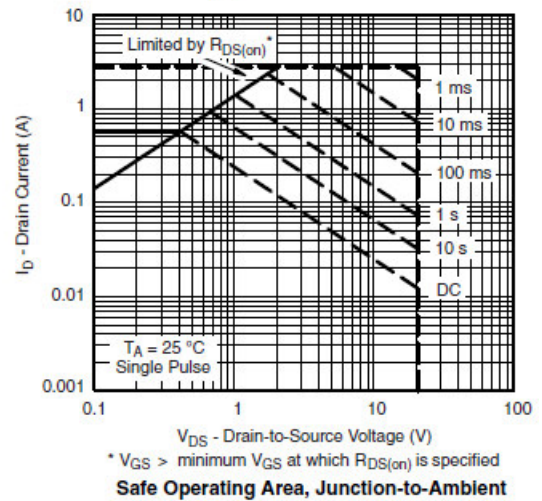
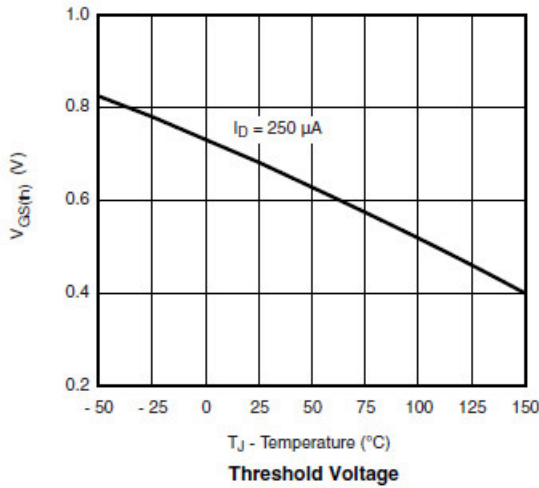
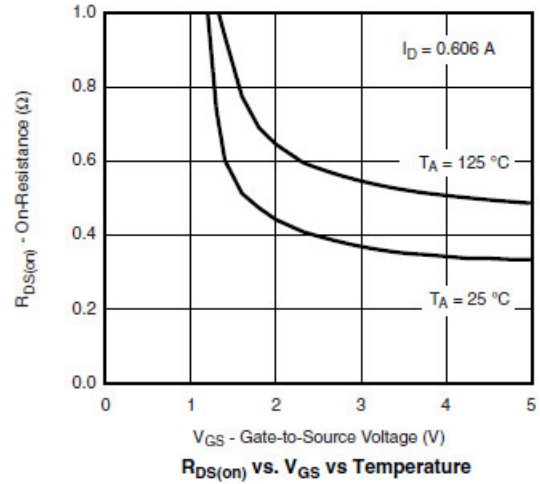
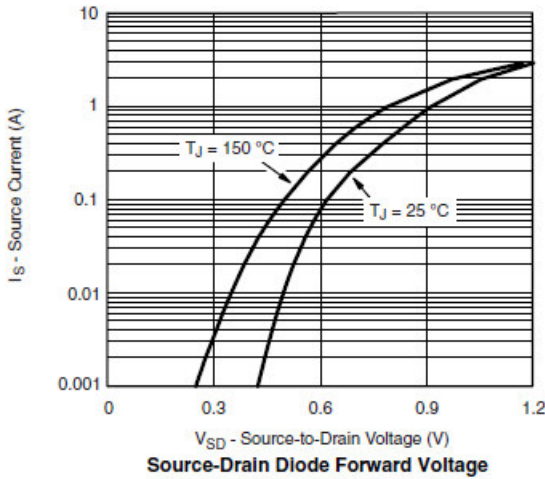



**Typical Characteristics**

Gate Charge Test Circuit & Waveform



Resistive Switching Test Circuit & Waveforms



Unclamped Inductive Switching Test Circuit & Waveforms

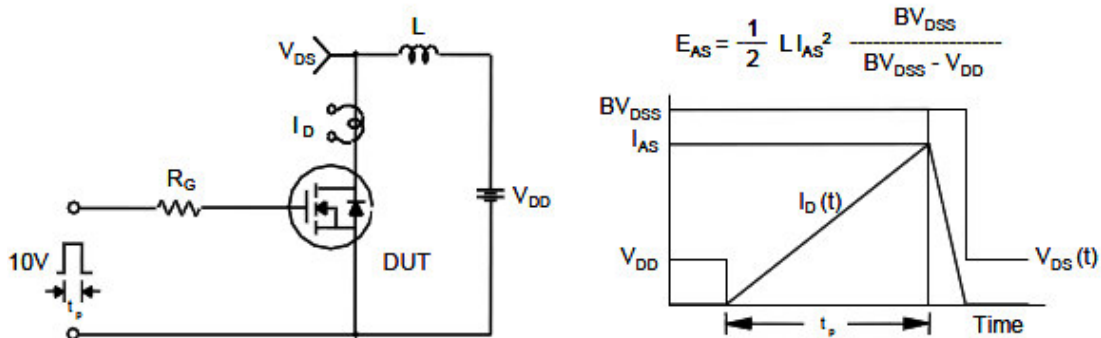



**Package Information ( SOT-23 )**

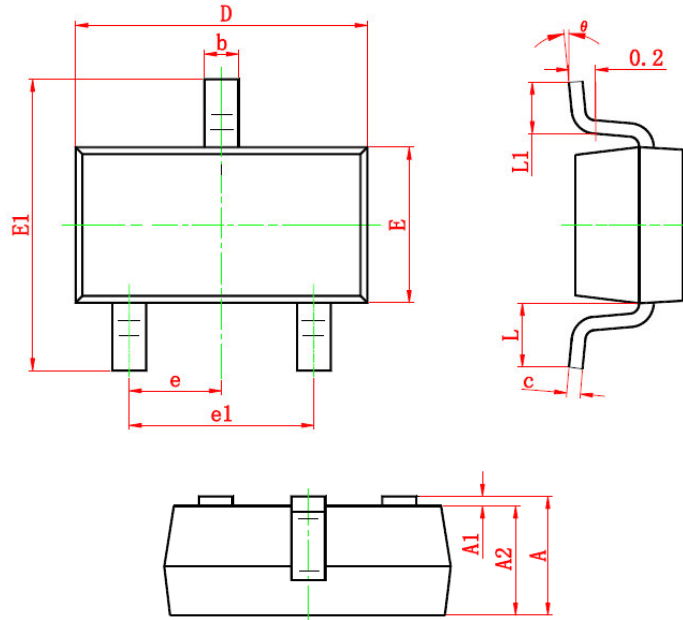

Symbol	Dimensions In Millimeters		Dimensions In Inches	
	Min	Max	Min	Max
A	0.900	1.200	0.035	0.043
A1	0.000	0.100	0.000	0.004
A2	0.900	1.100	0.035	0.039
b	0.300	0.500	0.012	0.020
c	0.080	0.150	0.003	0.006
D	2.800	3.000	0.110	0.118
E	1.200	1.400	0.047	0.055
E1	2.250	2.550	0.089	0.100
e	0.950 TYP		0.037 TYP	
e1	1.800	2.000	0.071	0.079
L	0.550 REF		0.022 REF	
L1	0.300	0.500	0.012	0.020
θ	0°	8°	0°	6°

©2010 Alfa-MOS Technology Corp.  
 2F, No.80, Sec.1, Cheng Kung Rd., Nan Kang Dist., Taipei City 115, Taiwan (R.O.C.)  
 Tel : 886 2) 2651 3928  
 Fax : 886 2) 2786 8483  
 ©http://www.alfa-mos.com