



### General Description

AFC3326WS, N & P Pair enhancement mode MOSFET, uses Advanced Trench Technology to provide excellent  $R_{DS(ON)}$ , low gate charge.

These devices are particularly suited for low voltage power management, and low in-line power loss are needed in commercial industrial surface mount applications.

### Features

N-Channel

- 30V/12A,  $R_{DS(ON)}=36m\Omega@V_{GS}=10V$
- 30V/10A,  $R_{DS(ON)}=46m\Omega@V_{GS}=4.5V$

P-Channel

- -30V/-8A,  $R_{DS(ON)}=60m\Omega@V_{GS}=10V$
- -30V/-6A,  $R_{DS(ON)}=80m\Omega@V_{GS}=4.5V$

### Pin Description (DFN3X3-8L)

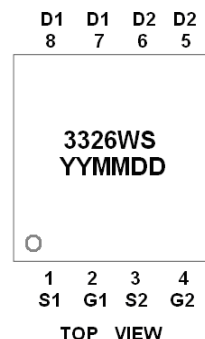
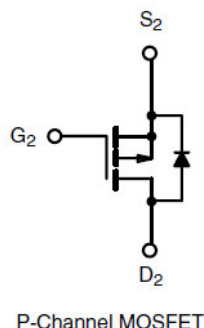
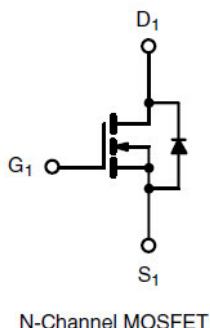
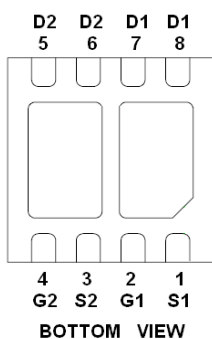

### Application

- DC/DC Conversion
- Load Switch
- DC FAN

### Pin Define

Pin	Symbol	Description
1	S1	Source 1
2	G1	Gate 1
3	S2	Source 2
4	G2	Gate 2
5	D2	Drain 2
6	D2	Drain 2
7	D1	Drain 1
8	D1	Drain 1

### Ordering Information

Part Ordering No.	Part Marking	Package	Unit	Quantity
AFC3326WSFN338RG	3326WS YYMMDD	DFN3X3-8L	Tape & Reel	5000 EA

※ YY year code

※ MM month code

※ DD date code

※ AFC3326WSFN338RG : 13" Tape & Reel ; Pb- Free ; Halogen- Free



**Absolute Maximum Ratings ( N-Channel )**

(T<sub>A</sub>=25°C Unless otherwise noted)

Parameter	Symbol	Typical	Unit
Drain-Source Voltage	V <sub>DSS</sub>	30	V
Gate –Source Voltage	V <sub>GSS</sub>	±20	V
Continuous Drain Current(T <sub>J</sub> =150°C)	I <sub>D</sub>	T <sub>A</sub> =25°C	12
		T <sub>A</sub> =70°C	10
Pulsed Drain Current	I <sub>DM</sub>	50	A
Continuous Source Current(Diode Conduction)	I <sub>S</sub>	10	A
Power Dissipation	P <sub>D</sub>	T <sub>A</sub> =25°C	2
		T <sub>A</sub> =70°C	1.5
Operating Junction Temperature	T <sub>J</sub>	150	°C
Storage Temperature Range	T <sub>STG</sub>	-55/150	°C
Thermal Resistance-Junction to Ambient	R <sub>θJA</sub>	56	°C/W

**Electrical Characteristics ( N-Channel )**

(T<sub>A</sub>=25°C Unless otherwise noted)

Parameter	Symbol	Conditions	Min.	Typ	Max.	Unit
<b>Static</b>						
Drain-Source Breakdown Voltage	V <sub>(BR)DSS</sub>	V <sub>GS</sub> =0V, I <sub>D</sub> =250uA	30			V
Gate Threshold Voltage	V <sub>GS(th)</sub>	V <sub>DS</sub> =V <sub>GS</sub> , I <sub>D</sub> =250uA	1.3		2.1	
Gate Leakage Current	I <sub>GSS</sub>	V <sub>DS</sub> =0V, V <sub>GS</sub> =±20V			±100	nA
Zero Gate Voltage Drain Current	I <sub>DSS</sub>	V <sub>DS</sub> =24V, V <sub>GS</sub> =0V			1	uA
		V <sub>DS</sub> =24V, V <sub>GS</sub> =0V T <sub>J</sub> =85°C			30	
On-State Drain Current	I <sub>D(on)</sub>	V <sub>DS</sub> ≥ 5V, V <sub>GS</sub> =4.5V	10			A
Drain-Source On-Resistance	R <sub>DS(on)</sub>	V <sub>GS</sub> =10V, I <sub>D</sub> =12A		30	36	mΩ
		V <sub>GS</sub> =4.5V, I <sub>D</sub> =10A		40	46	
Forward Transconductance	g <sub>FS</sub>	V <sub>DS</sub> =15V, I <sub>D</sub> =5.2A		13		S
Diode Forward Voltage	V <sub>SD</sub>	I <sub>S</sub> =1.6A, V <sub>GS</sub> =0V		0.8	1.3	V
<b>Dynamic</b>						
Total Gate Charge	Q <sub>g</sub>	V <sub>DS</sub> =20V, V <sub>GS</sub> =4.5V I <sub>D</sub> ≅5.2A		8	12	nC
Gate-Source Charge	Q <sub>gs</sub>			1.6		
Gate-Drain Charge	Q <sub>gd</sub>			2.4		
Input Capacitance	C <sub>iss</sub>	V <sub>DS</sub> =20V, V <sub>GS</sub> =0V f=1MHz		700		pF
Output Capacitance	C <sub>oss</sub>			75		
Reverse Transfer Capacitance	C <sub>rss</sub>			45		
Turn-On Time	t <sub>d(on)</sub>	V <sub>DD</sub> =15V, R <sub>L</sub> =15Ω I <sub>D</sub> ≅1.0A, V <sub>GEN</sub> =10V R <sub>G</sub> =6Ω		8	12	ns
	t <sub>r</sub>			12	18	
Turn-Off Time	t <sub>d(off)</sub>			28	40	
	t <sub>f</sub>			10	18	



**Absolute Maximum Ratings ( P-Channel )**

(T<sub>A</sub>=25°C Unless otherwise noted)

Parameter	Symbol	Typical	Unit
Drain-Source Voltage	V <sub>DSS</sub>	-30	V
Gate –Source Voltage	V <sub>GSS</sub>	±20	V
Continuous Drain Current(T <sub>J</sub> =150°C)	I <sub>D</sub>	T <sub>A</sub> =25°C	-8.0
		T <sub>A</sub> =70°C	-6.0
Pulsed Drain Current	I <sub>DM</sub>	-30	A
Continuous Source Current(Diode Conduction)	I <sub>S</sub>	-10	A
Power Dissipation	P <sub>D</sub>	T <sub>A</sub> =25°C	1.8
		T <sub>A</sub> =70°C	1.2
Operating Junction Temperature	T <sub>J</sub>	150	°C
Storage Temperature Range	T <sub>STG</sub>	-55/150	°C
Thermal Resistance-Junction to Ambient	R <sub>θJA</sub>	62.5	°C/W

**Electrical Characteristics ( P-Channel )**

(T<sub>A</sub>=25°C Unless otherwise noted)

Parameter	Symbol	Conditions	Min.	Typ	Max.	Unit
<b>Static</b>						
Drain-Source Breakdown Voltage	V <sub>(BR)DSS</sub>	V <sub>GS</sub> =0V, I <sub>D</sub> =-250uA	-30			V
Gate Threshold Voltage	V <sub>GS(th)</sub>	V <sub>DS</sub> =V <sub>GS</sub> , I <sub>D</sub> =-250uA	-1.0		-2.0	
Gate Leakage Current	I <sub>GSS</sub>	V <sub>DS</sub> =0V, V <sub>GS</sub> =±20V			±100	nA
Zero Gate Voltage Drain Current	I <sub>DSS</sub>	V <sub>DS</sub> =-24V, V <sub>GS</sub> =0V			1	uA
		V <sub>DS</sub> =-24V, V <sub>GS</sub> =0V T <sub>J</sub> =85°C			-30	
On-State Drain Current	I <sub>D(on)</sub>	V <sub>DS</sub> ≥ -5V, V <sub>GS</sub> =-10V	25			A
Drain-Source On-Resistance	R <sub>DS(on)</sub>	V <sub>GS</sub> =-10V, I <sub>D</sub> =-8A		50	60	mΩ
		V <sub>GS</sub> =-4.5V, I <sub>D</sub> =-6A		70	80	
Forward Transconductance	g <sub>FS</sub>	V <sub>DS</sub> =-10V, I <sub>D</sub> =-4.9A		10		S
Diode Forward Voltage	V <sub>SD</sub>	I <sub>S</sub> =-1.7A, V <sub>GS</sub> =0V		0.8	1.3	V
<b>Dynamic</b>						
Total Gate Charge	Q <sub>g</sub>	V <sub>DS</sub> =-15V, V <sub>GS</sub> =-10V I <sub>D</sub> ≡-5.0A		10	18	nC
Gate-Source Charge	Q <sub>gs</sub>			1.6		
Gate-Drain Charge	Q <sub>gd</sub>			3.0		
Input Capacitance	C <sub>iss</sub>	V <sub>DS</sub> =-15V, V <sub>GS</sub> =0V f=1MHz		500		pF
Output Capacitance	C <sub>oss</sub>			100		
Reverse Transfer Capacitance	C <sub>rss</sub>			55		
Turn-On Time	t <sub>d(on)</sub>	V <sub>DD</sub> =-15V, R <sub>L</sub> =15Ω I <sub>D</sub> ≡-1.0A, V <sub>GEN</sub> =10V R <sub>G</sub> =6Ω		8	18	ns
	t <sub>r</sub>			8	18	
Turn-Off Time	t <sub>d(off)</sub>			25	50	
	t <sub>f</sub>			25	35	



## Typical Characteristics ( N-Channel )

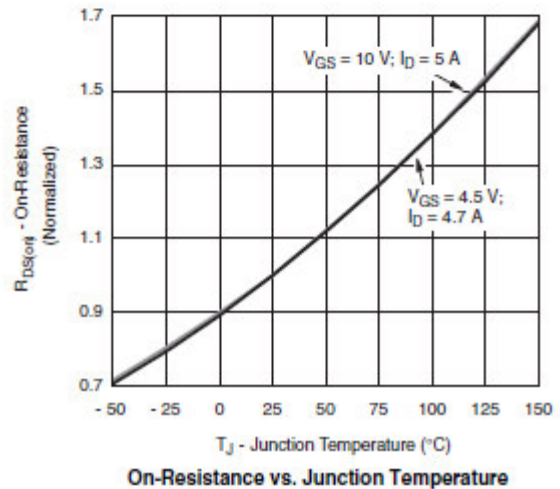
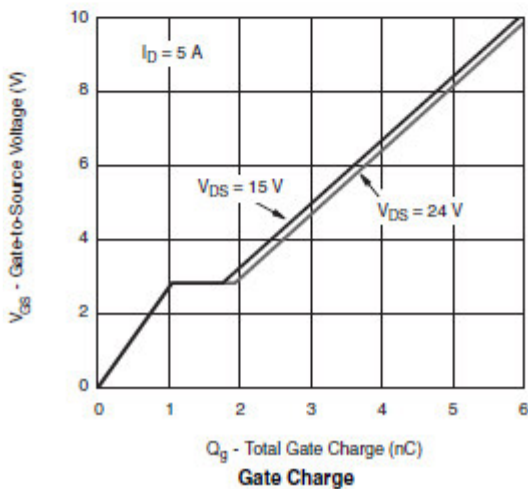
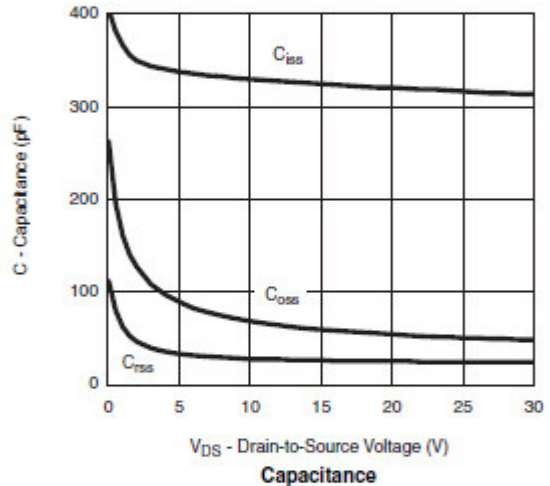
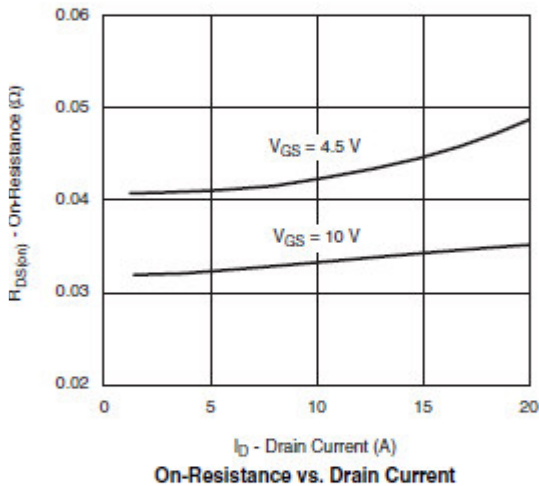
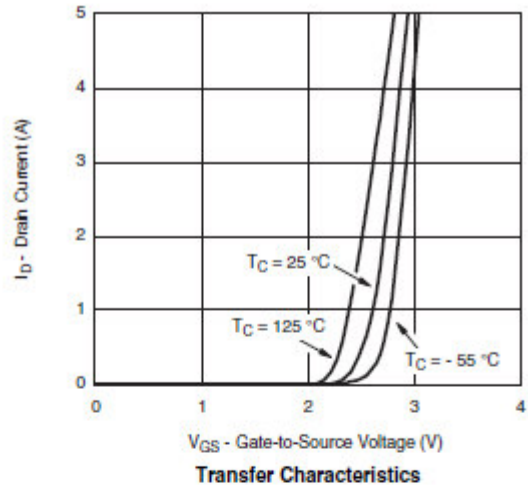
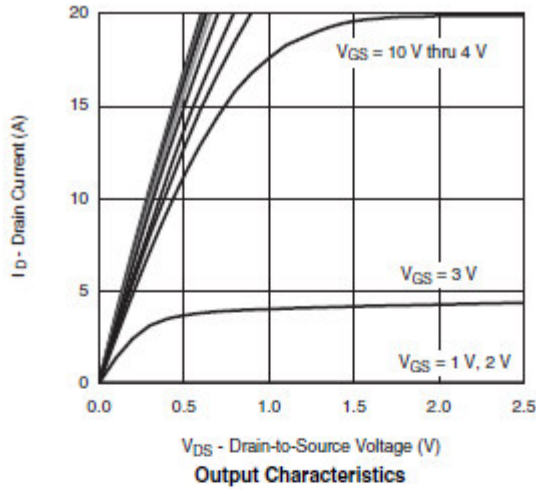



## Typical Characteristics ( N-Channel )

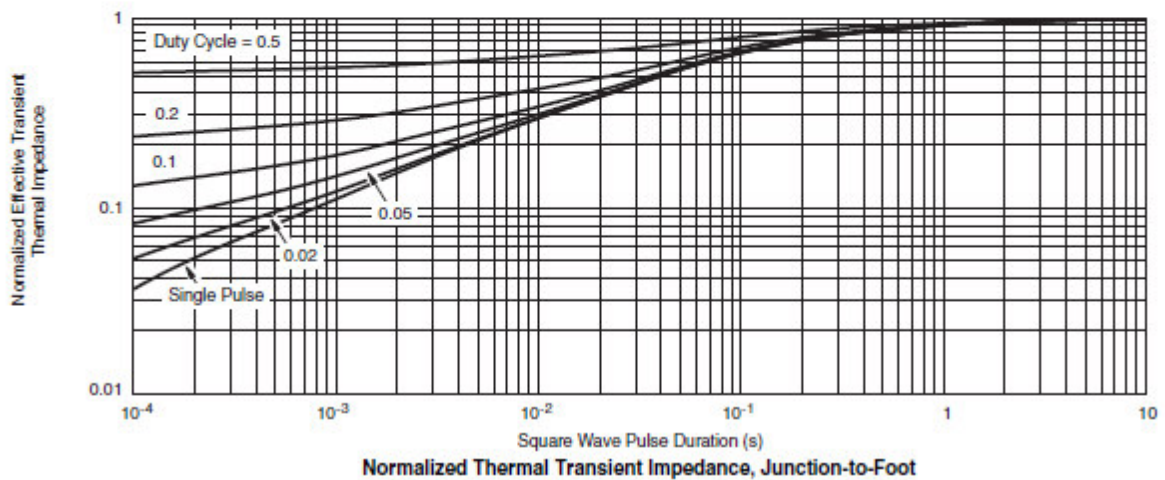
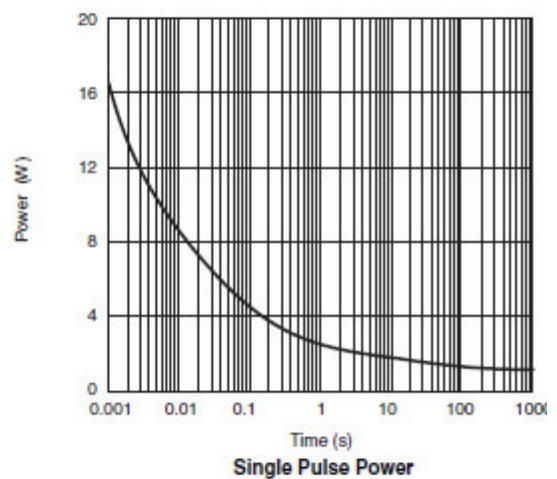
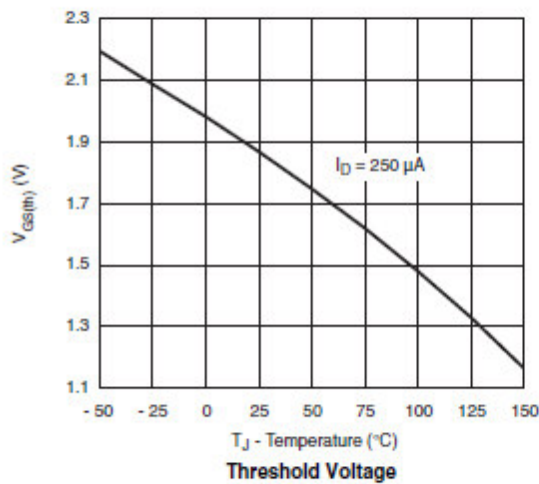
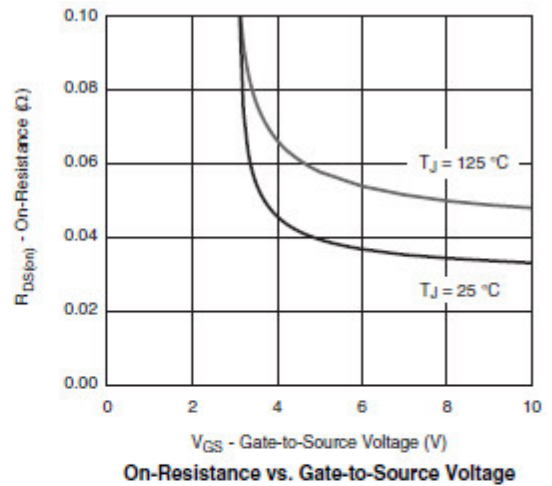
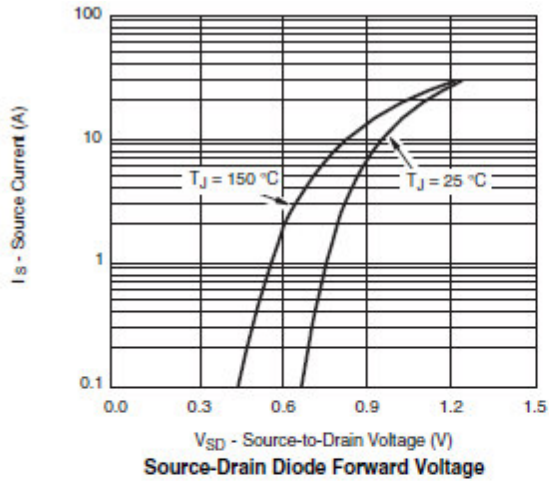



## Typical Characteristics ( P-Channel )

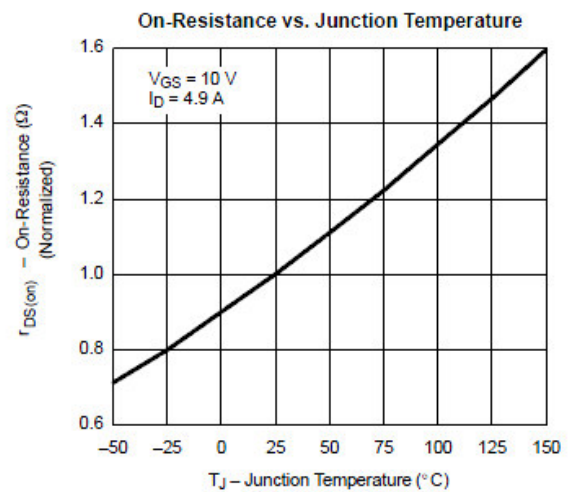
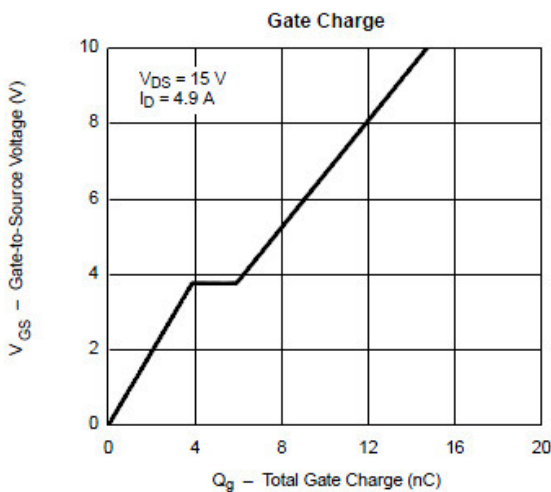
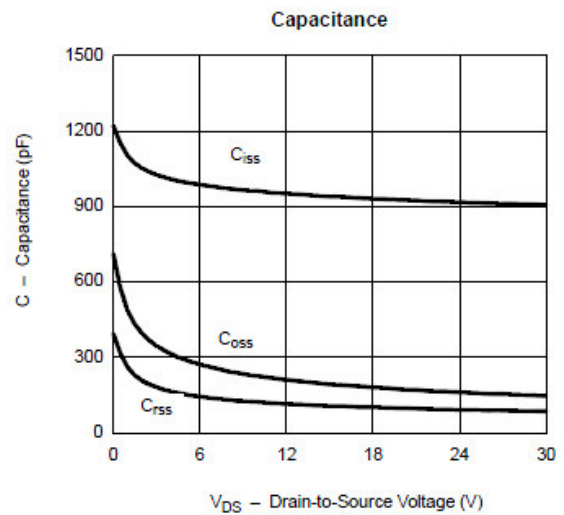
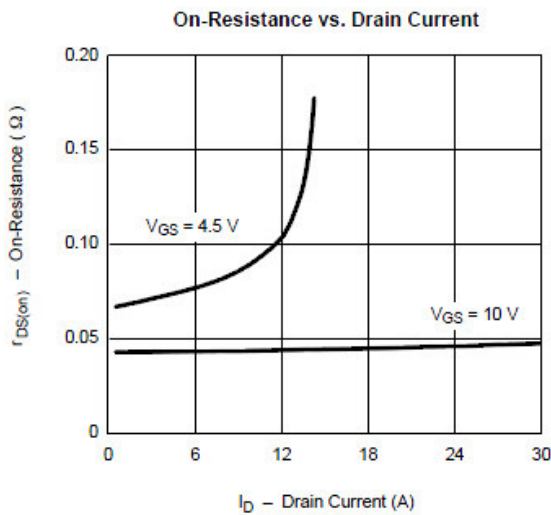
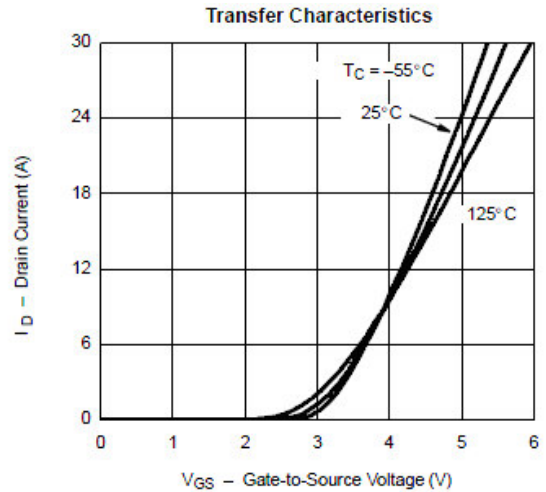
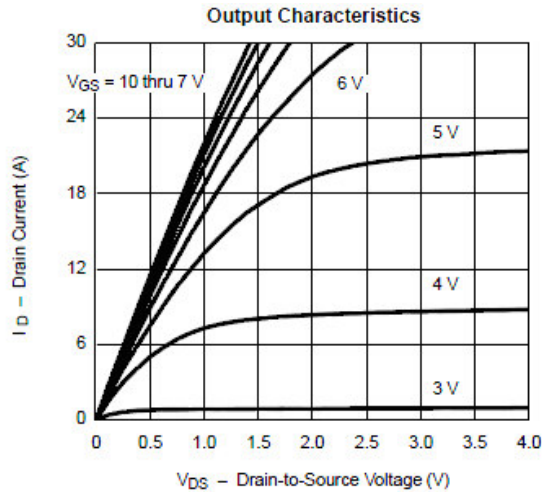





## Typical Characteristics ( P-Channel )

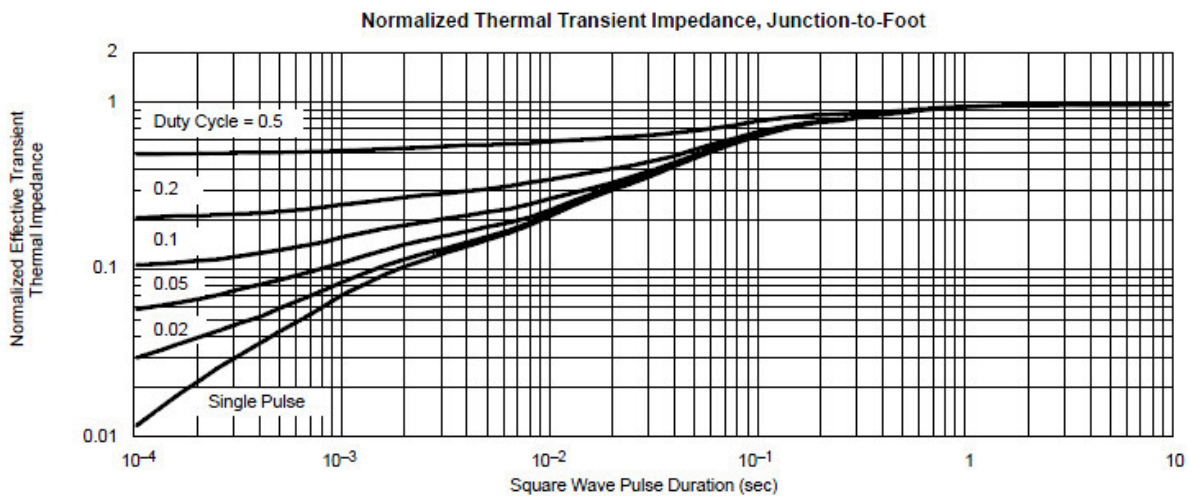
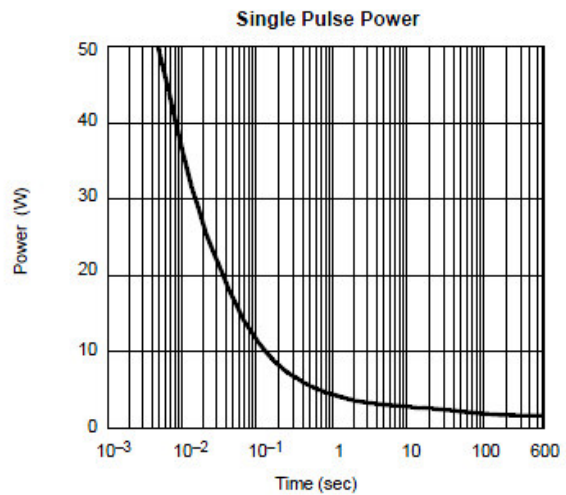
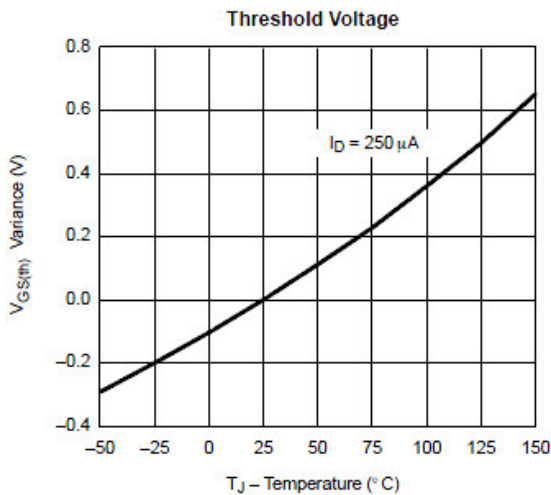
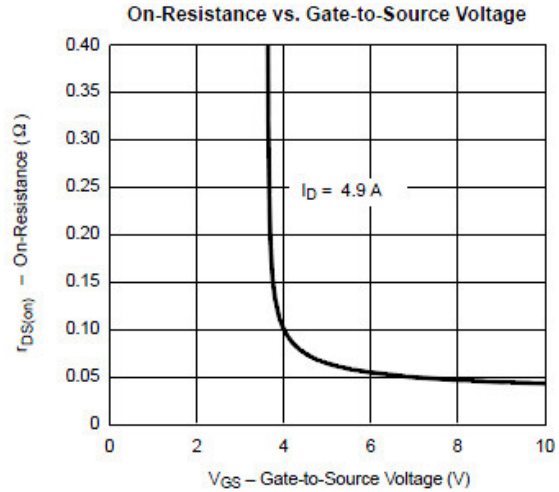
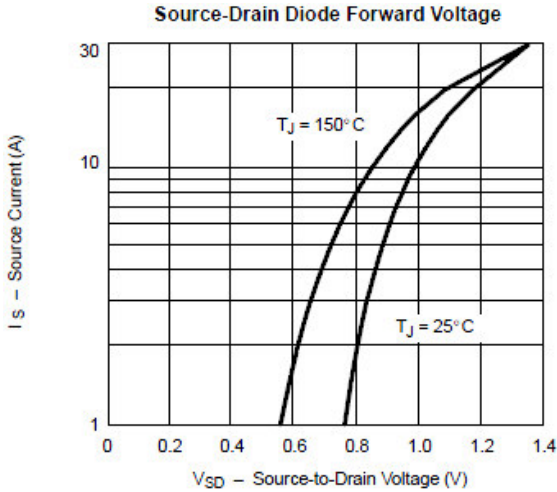



**Typical Characteristics**

Gate Charge Test Circuit & Waveform

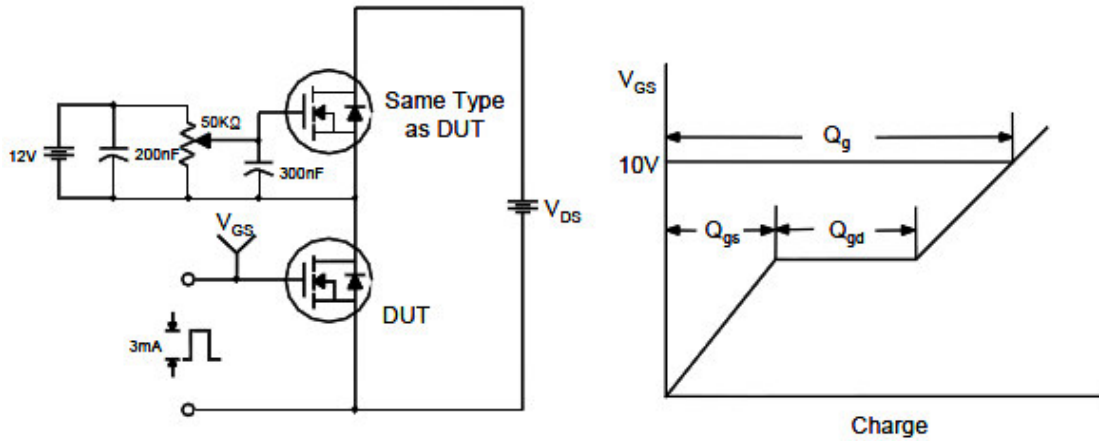

Resistive Switching Test Circuit & Waveforms

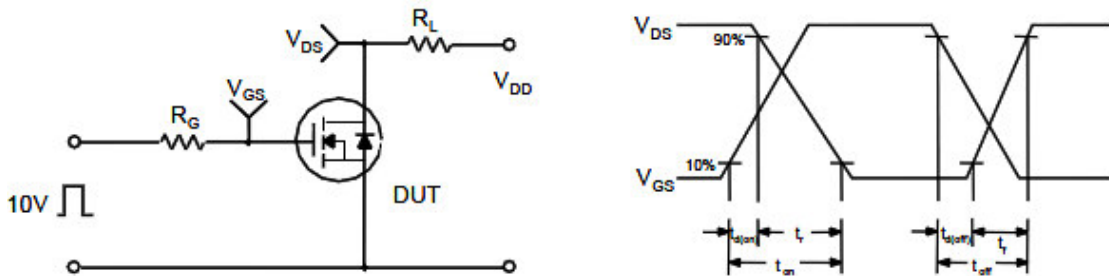

Unclamped Inductive Switching Test Circuit & Waveforms

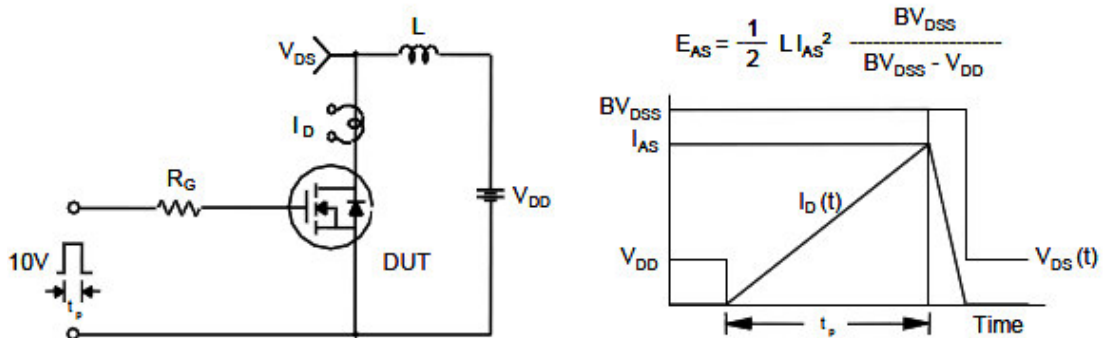





**Package Information ( DFN3X3-8L )**

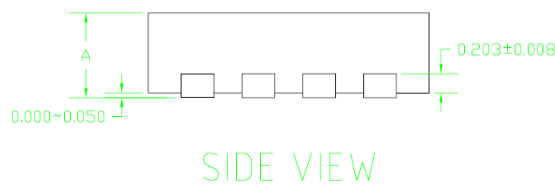
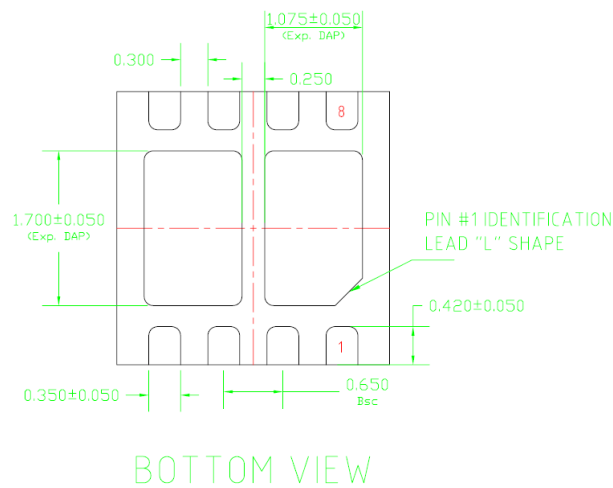
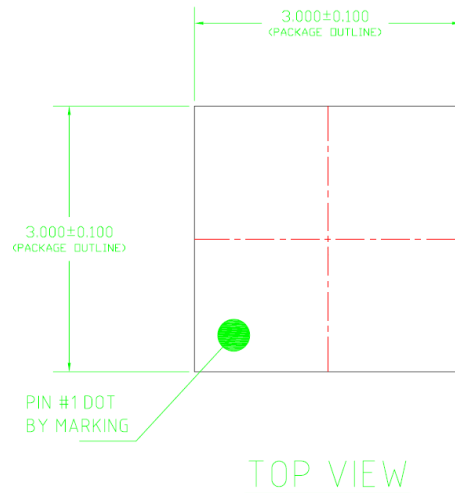

©2010 Alfa-MOS Technology Corp.  
2F, No.80, Sec.1, Cheng Kung Rd., Nan Kang Dist., Taipei City 115, Taiwan (R.O.C.)  
Tel : 886 2) 2651 3928  
Fax : 886 2) 2786 8483  
©http://www.alfa-mos.com