



General Description

AFC1563, N & P Pair enhancement mode MOSFET, uses Advanced Trench Technology to provide excellent $R_{DS(ON)}$, low gate charge. These devices are particularly suited for low voltage power management, such as smart phone and notebook computer and other battery powered circuits, and low in-line power loss are needed in commercial industrial surface mount applications.

Features

- N-Channel
20V/1.0A, $R_{DS(ON)}=280m\Omega@V_{GS}=4.5V$
20V/0.8A, $R_{DS(ON)}=340m\Omega@V_{GS}=2.5V$
20V/0.7A, $R_{DS(ON)}=580m\Omega@V_{GS}=1.8V$
- P-Channel
-20V/-0.6A, $R_{DS(ON)}= 600 m\Omega@ V_{GS} =-4.5V$
-20V/-0.5A, $R_{DS(ON)}= 840 m\Omega@ V_{GS} =-2.5V$
-20V/-0.4A, $R_{DS(ON)}= 1440 m\Omega@ V_{GS} =-1.8V$
- Low-Voltage Operation
- High-Speed Circuits
- Low Battery Voltage Operation
- SOT-363 package design

Pin Description (SOT-363)

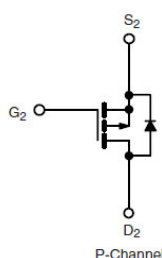
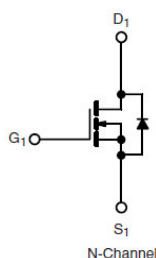
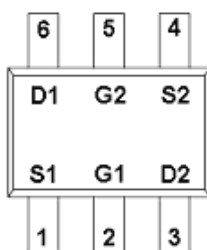

Application

- Load Switch for Portable Devices, Smart Phones, Pagers

Pin Define

Pin	Symbol	Description
1	S1	Source 1
2	G1	Gate 1
3	D2	Drain 2
4	S2	Source 2
5	G2	Gate 2
6	D1	Drain1

Ordering Information

Part Ordering No.	Part Marking	Package	Unit	Quantity
AFC1563S36RG	63YW	SOT-363	Tape & Reel	3000 EA

- ※ 63 parts code
- ※ Y year code (0 ~ 9)
- ※ W week code (A ~ Z = 1 ~ 26 / a ~ z = 27 ~ 52)
- ※ AFC1563S36RG : 7" Tape & Reel ; Pb- Free ; Halogen- Free



Absolute Maximum Ratings

(T_A=25°C Unless otherwise noted)

Parameter	Symbol	Typical		Unit	
		N-Channel	P-Channel		
Drain-Source Voltage	V _{DSS}	20	-20	V	
Gate –Source Voltage	V _{GSS}	±12	±12	V	
Continuous Drain Current(T _J =150°C)	I _D	T _A =25°C	1.0	-0.6	A
		T _A =70°C	0.7	-0.4	
Pulsed Drain Current	I _{DM}	6	-6	A	
Continuous Source Current(Diode Conduction)	I _S	1	-1	A	
Power Dissipation	P _D	T _A =25°C	0.3		W
		T _A =70°C	0.2		
Operating Junction Temperature	T _J	-55/150		°C	
Storage Temperature Range	T _{STG}	-55/150		°C	

Electrical Characteristics (N-Channel)

(T_A=25°C Unless otherwise noted)

Parameter	Symbol	Conditions	Min.	Typ	Max.	Unit
Static						
Drain-Source Breakdown Voltage	V _{(BR)DSS}	V _{GS} =0V, I _D =250uA	20			V
Gate Threshold Voltage	V _{GS(th)}	V _{DS} =V _{GS} , I _D =250uA	0.4		1.0	
Gate Leakage Current	I _{GSS}	V _{DS} =0V, V _{GS} =±12V			±100	nA
Zero Gate Voltage Drain Current	I _{DSS}	V _{DS} =20V, V _{GS} =0V			1	uA
		V _{DS} =20V, V _{GS} =0V T _J =85°C			5	
On-State Drain Current	I _{D(on)}	V _{DS} ≥ 5V, V _{GS} =4.5V	1.2			A
Drain-Source On-Resistance	R _{DS(on)}	V _{GS} =4.5V, I _D =1.0A		220	280	mΩ
		V _{GS} =2.5V, I _D =0.8A		260	340	
		V _{GS} =1.8V, I _D =0.7A		340	580	
Forward Transconductance	g _{FS}	V _{DS} =10V, I _D =1.0A		1		S
Diode Forward Voltage	V _{SD}	I _S =1.0A, V _{GS} =0V		0.65	1.2	V
Dynamic						
Input Capacitance	C _{iss}	V _{DS} =10V, V _{GS} =0V f=1MHz		70		pF
Output Capacitance	C _{oss}			20		
Reverse Transfer Capacitance	C _{rss}			8		
Total Gate Charge	Q _g	V _{DS} =10V, V _{GS} =4.5V I _D ≅1.2A		1.06	1.38	nC
Gate-Source Charge	Q _{gs}			0.18		
Gate-Drain Charge	Q _{gd}			0.32		
Turn-On Time	t _{d(on)}	V _{DD} =10V, R _L =20Ω I _D ≅1.2A, V _{GEN} =4.5V R _G =1Ω		18	26	ns
	t _r			20	28	
Turn-Off Time	t _{d(off)}			70	110	
	t _f			25	40	



Electrical Characteristics (P-Channel)

(T_A=25°C Unless otherwise noted)

Parameter	Symbol	Conditions	Min.	Typ	Max.	Unit
Static						
Drain-Source Breakdown Voltage	V _{(BR)DSS}	V _{GS} =0V, I _D =-250uA	-20			V
Gate Threshold Voltage	V _{GS(th)}	V _{DS} =V _{GS} , I _D =-250uA	-0.4		-1.0	
Gate Leakage Current	I _{GSS}	V _{DS} =0V, V _{GS} =±12V			±100	nA
Zero Gate Voltage Drain Current	I _{DSS}	V _{DS} =-20V, V _{GS} =0V			-1	uA
		V _{DS} =-20V, V _{GS} =0V T _J =85°C			-5	
On-State Drain Current	I _{D(on)}	V _{DS} ≥ 5V, V _{GS} =4.5V	0.7			A
Drain-Source On-Resistance	R _{DS(on)}	V _{GS} =-4.5V, I _D =-0.6A		500	600	mΩ
		V _{GS} =-2.5V, I _D =-0.5A		700	840	
		V _{GS} =-1.8V, I _D =-0.4A		1000	1440	
Forward Transconductance	g _{FS}	V _{DS} =-10V, I _D =-0.4A		1		S
Diode Forward Voltage	V _{SD}	I _S =-0.15A, V _{GS} =0V		0.65	1.2	V
Dynamic						
Input Capacitance	C _{iss}	V _{DS} =-10V, V _{GS} =0V f=1MHz		70	100	pF
Output Capacitance	C _{oss}			20		
Reverse Transfer Capacitance	C _{rss}			10		
Total Gate Charge	Q _g	V _{DS} =-10V, V _{GS} =-4.5V I _D ≡-0.25A		1.0	1.3	nC
Gate-Source Charge	Q _{gs}			0.1		
Gate-Drain Charge	Q _{gd}			0.3		
Turn-On Time	t _{d(on)}	V _{DD} =-10V, R _L =30Ω I _D ≡-0.2A, V _{GEN} =-4.5V R _G =10Ω		10	15	ns
	t _r			10	15	
Turn-Off Time	t _{d(off)}			40	60	
	t _f			30	50	



Typical Characteristics (N-Channel)

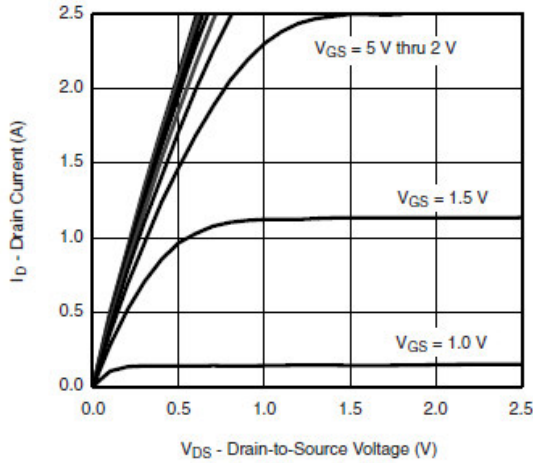

Output Characteristics

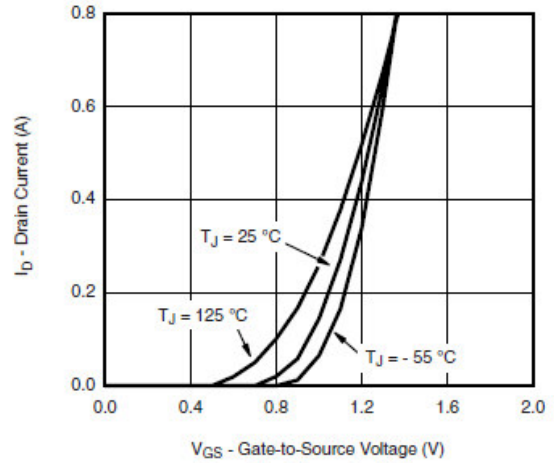

Transfer Characteristics

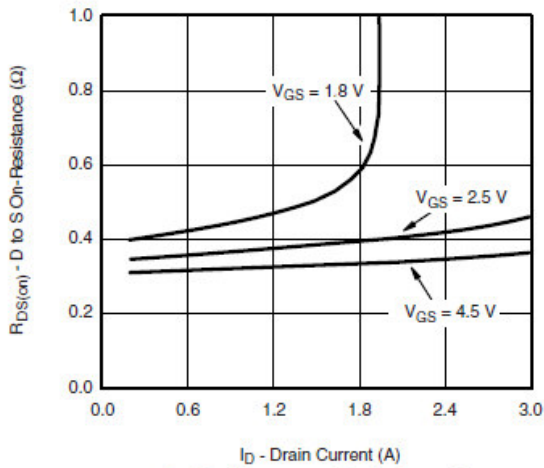

On-Resistance vs. Drain Current

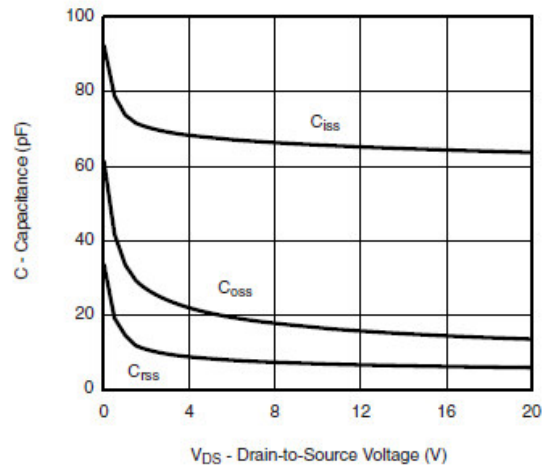

Capacitance

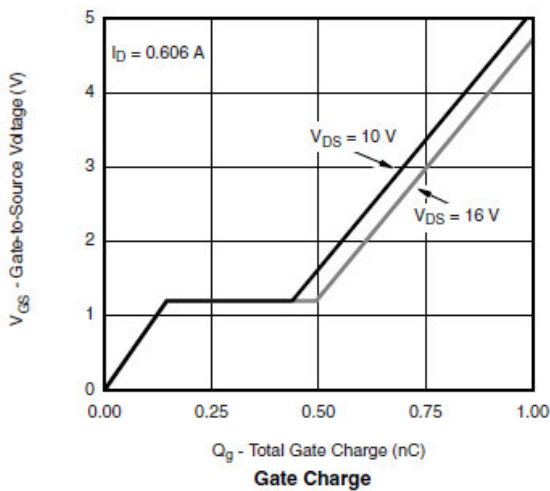

Gate Charge

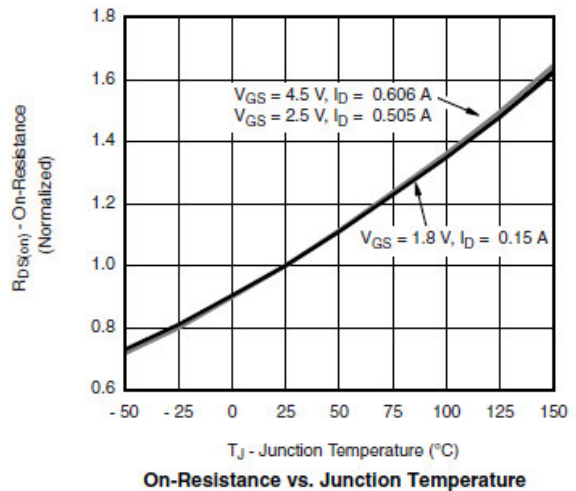

On-Resistance vs. Junction Temperature



Typical Characteristics (N-Channel)

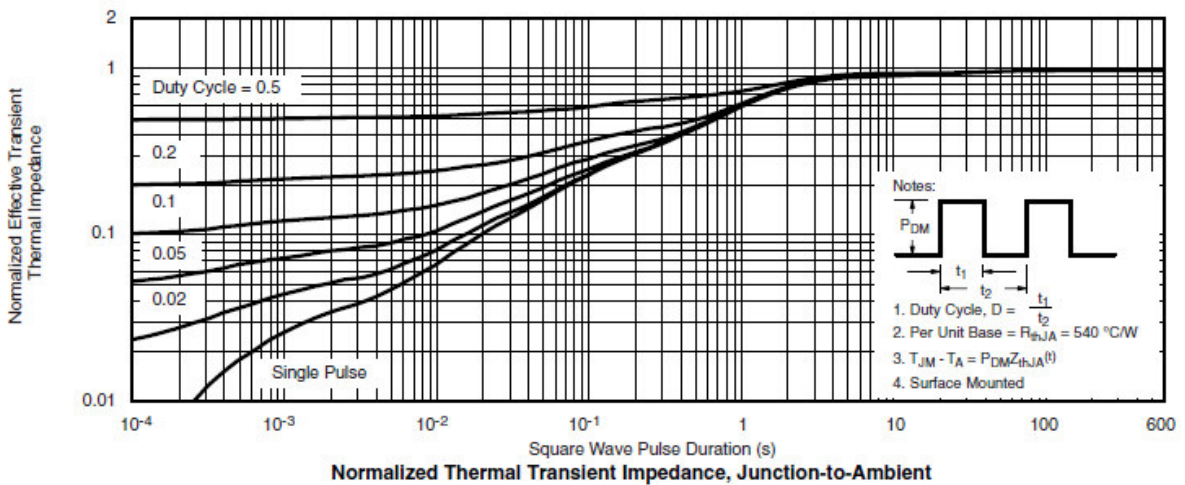
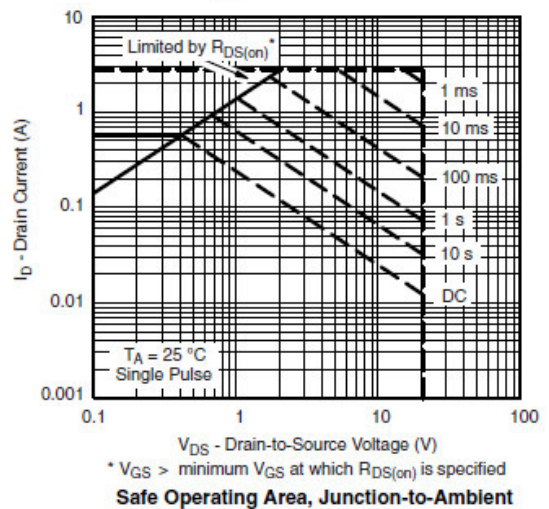
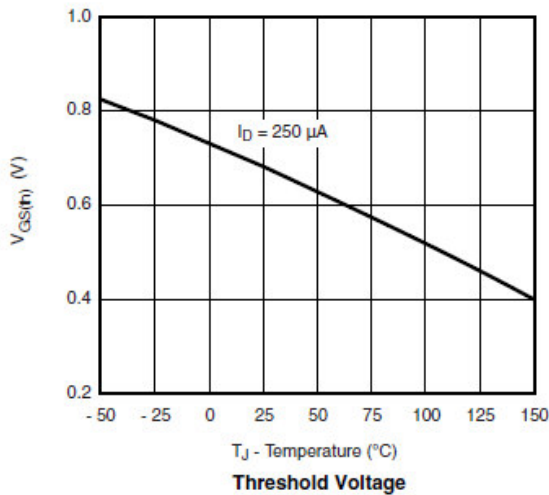
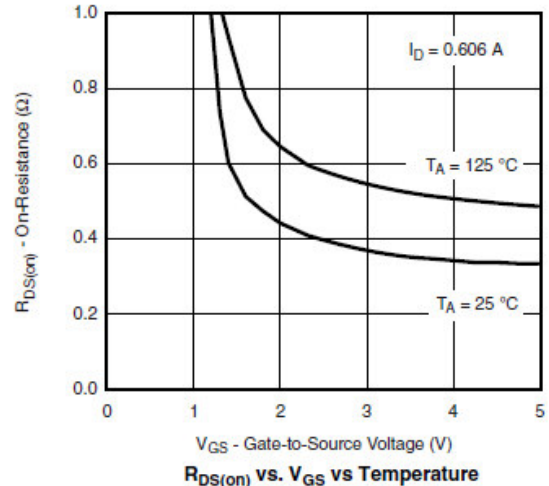
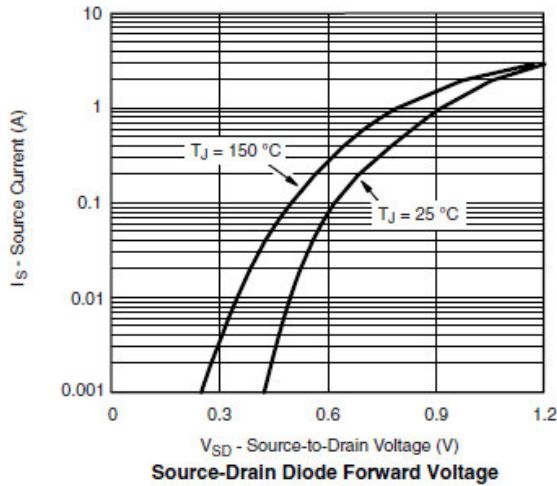



Typical Characteristics (N-Channel)

Gate Charge Test Circuit & Waveform

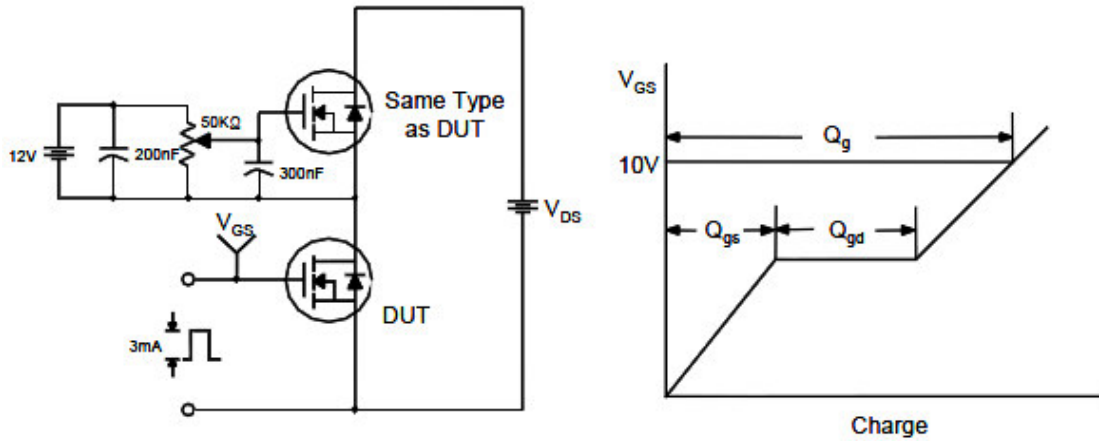

Resistive Switching Test Circuit & Waveforms

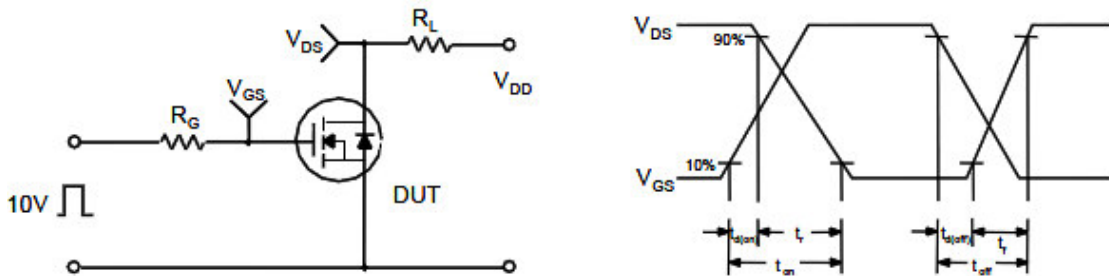

Unclamped Inductive Switching Test Circuit & Waveforms

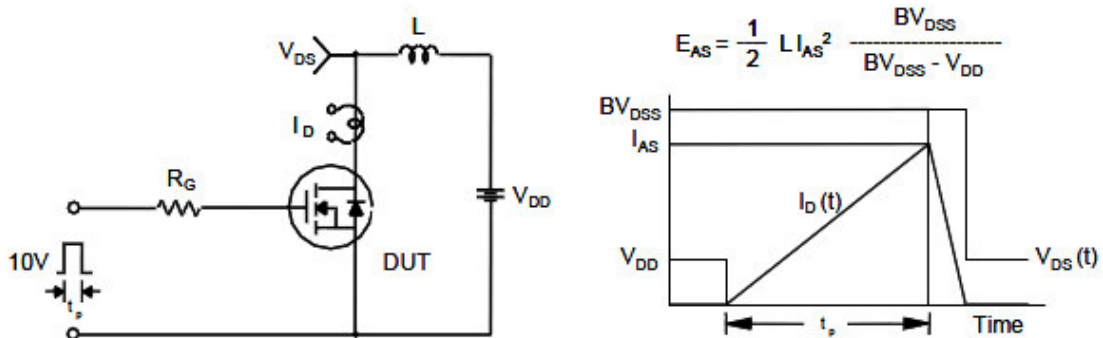



Typical Characteristics (P-Channel)

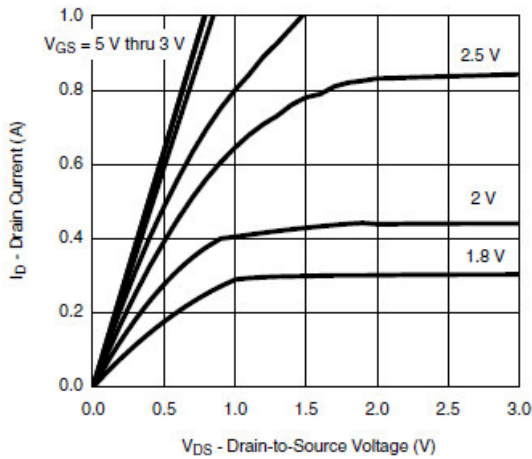

Output Characteristics

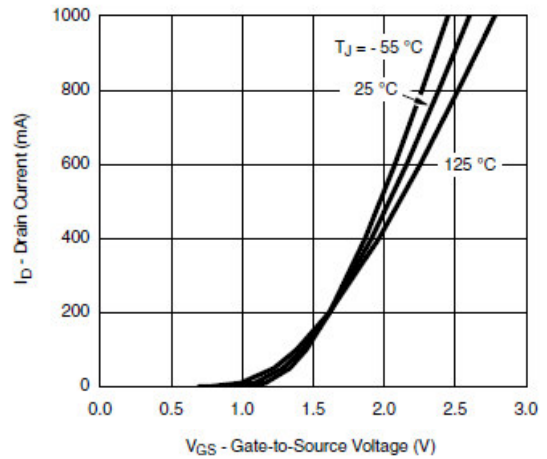

Transfer Characteristics

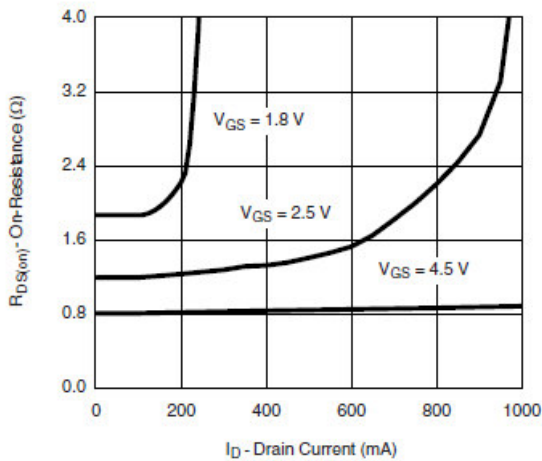

On-Resistance vs. Drain Current

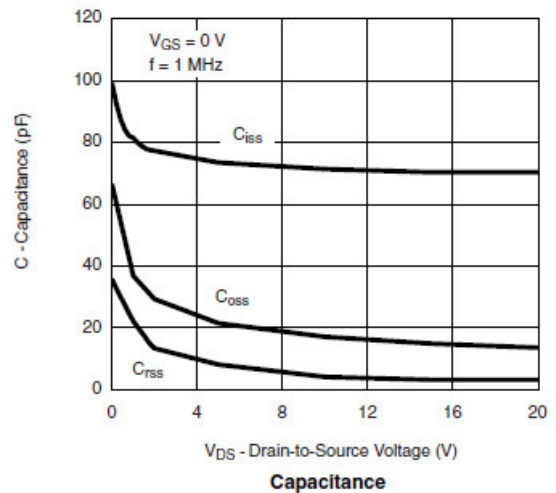

Capacitance

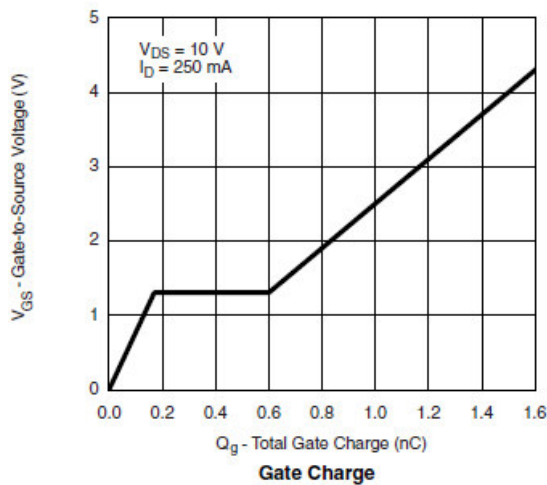

Gate Charge

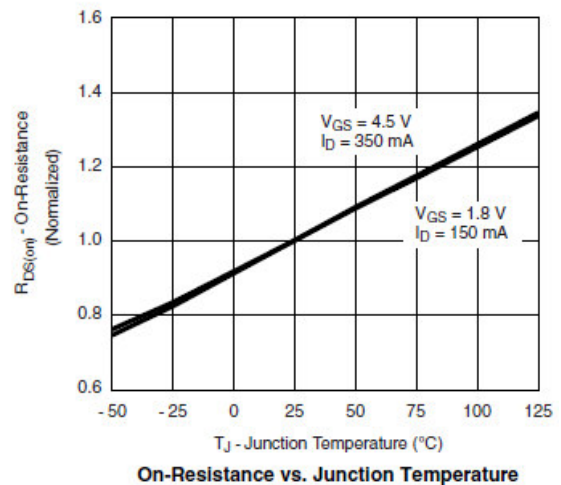

On-Resistance vs. Junction Temperature



Typical Characteristics (P-Channel)

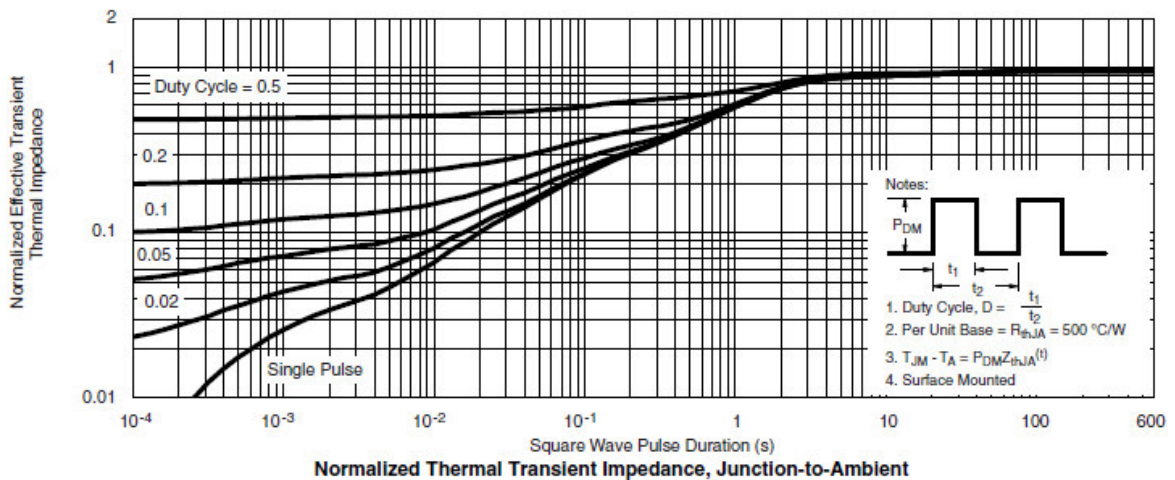
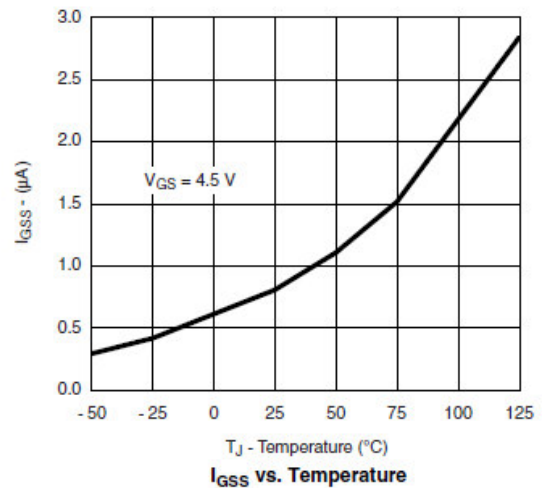
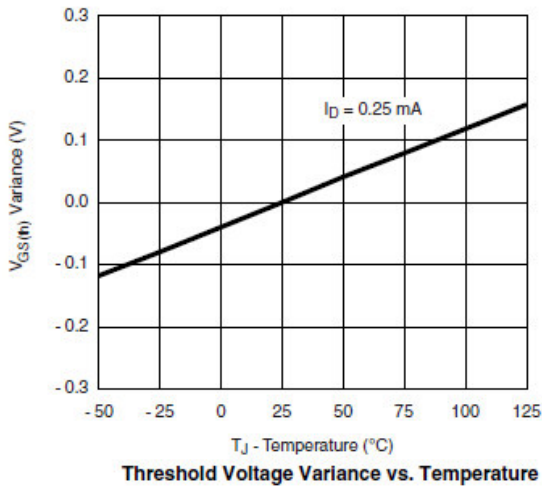
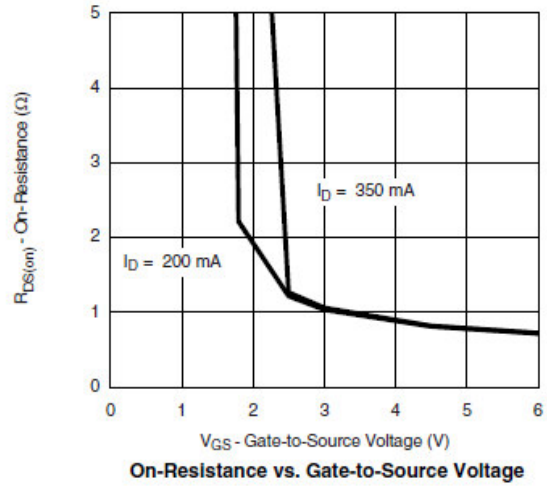
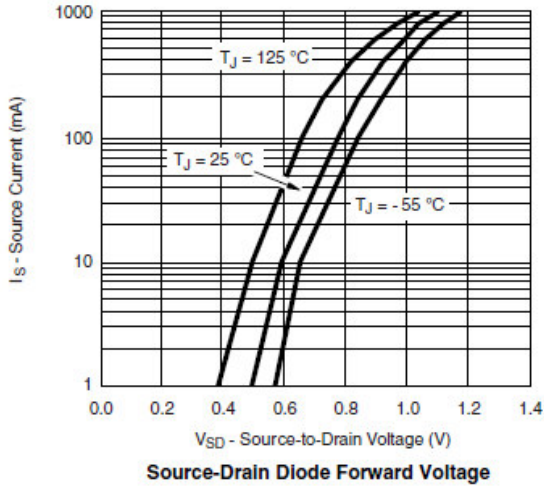



Typical Characteristics (P-Channel)

Gate Charge Test Circuit & Waveform

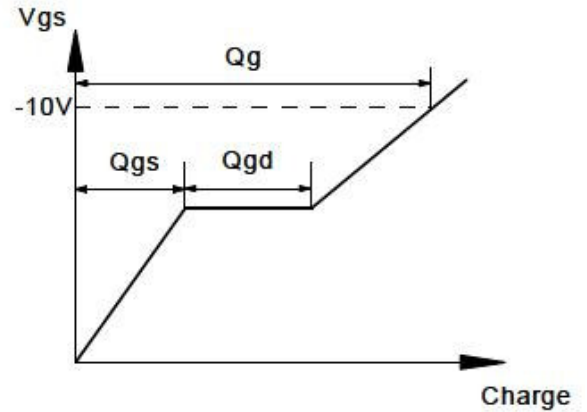
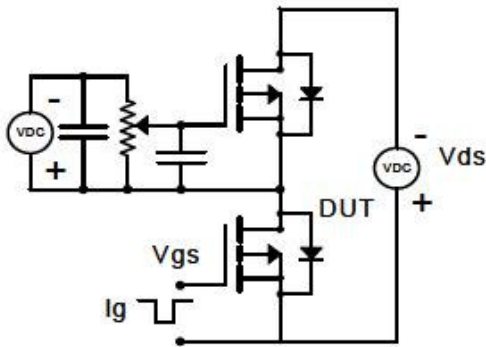

Resistive Switching Test Circuit & Waveforms

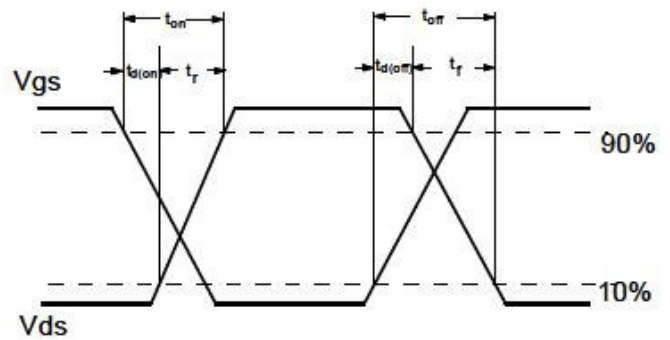
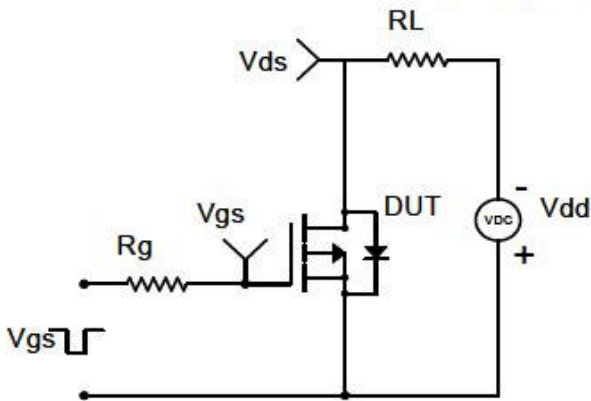

Diode Recovery Test Circuit & Waveforms

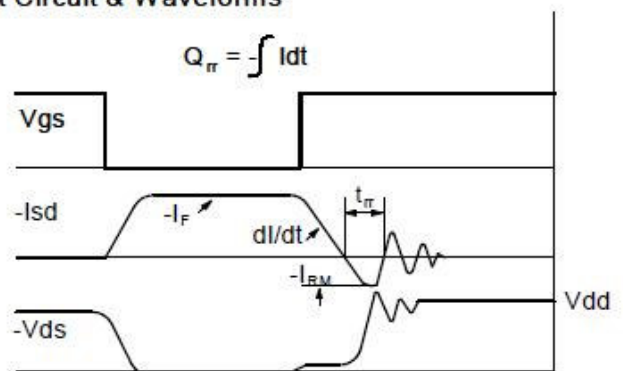
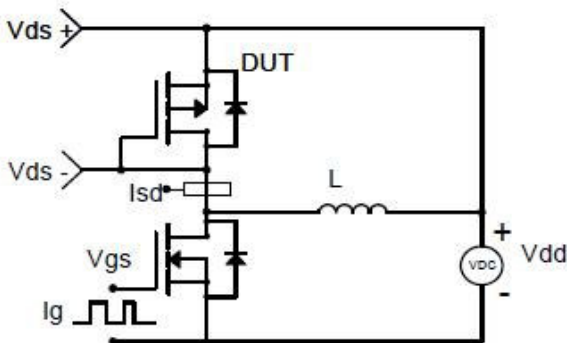



Package Information (SOT-363)

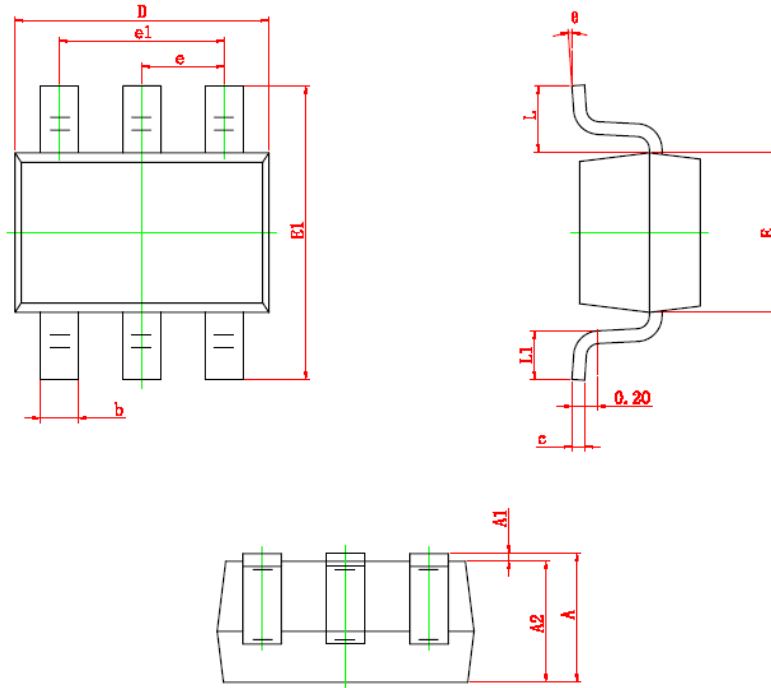

Symbol	Dimensions In Millimeters		Dimensions In Inches	
	Min	Max	Min	Max
A	0.900	1.100	0.035	0.043
A1	0.000	0.100	0.000	0.004
A2	0.900	1.000	0.035	0.039
b	0.150	0.350	0.006	0.014
c	0.080	0.150	0.003	0.006
D	2.000	2.200	0.079	0.087
E	1.150	1.350	0.045	0.053
E1	2.150	2.450	0.085	0.096
e	0.650 TYP		0.026 TYP	
e1	1.200	1.400	0.047	0.055
L	0.525 REF		0.021 REF	
L1	0.260	0.460	0.010	0.018
θ	0°	8°	0°	8°

©2010 Alfa-MOS Technology Corp.
 2F, No.80, Sec.1, Cheng Kung Rd., Nan Kang Dist., Taipei City 115, Taiwan (R.O.C.)
 Tel : 886 2) 2651 3928
 Fax : 886 2) 2786 8483
 ©http://www.alfa-mos.com