



N-Channel 240-V (D-S) MOSFETs

PRODUCT SUMMARY				
Part Number	$V_{(BR)DSS}$ Min (V)	$r_{DS(on)}$ Max (Ω)	$V_{GS(th)}$ (V)	I_D (A)
TN2410L	240	10 @ $V_{GS} = 4.5$ V	0.5 to 1.8	0.18
VN2406D		6 @ $V_{GS} = 10$ V	0.8 to 2	1.12
VN2406L		6 @ $V_{GS} = 10$ V	0.8 to 2	0.18
VN2410L		10 @ $V_{GS} = 10$ V	0.8 to 2	0.18
VN2410LS		10 @ $V_{GS} = 10$ V	0.8 to 2	0.19

FEATURES

- Low On-Resistance: 3.5 Ω
- Secondary Breakdown Free: 260 V
- Low Power/Voltage Driven
- Low Input and Output Leakage
- Excellent Thermal Stability

BENEFITS

- Low Offset Voltage
- Full-Voltage Operation
- Easily Driven Without Buffer
- Low Error Voltage
- No High-Temperature "Run-Away"

APPLICATIONS

- High-Voltage Drivers: Relays, Solenoids, Lamps, Hammers, Displays, Transistors, etc.
- Telephone Mute Switches, Ringer Circuits
- Power Supply, Converters
- Motor Control

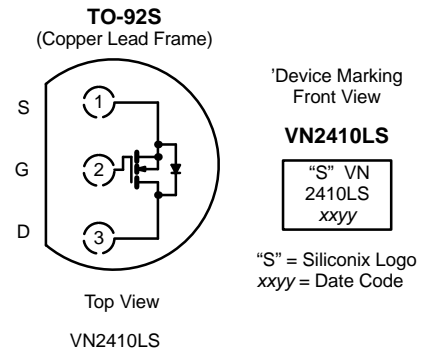
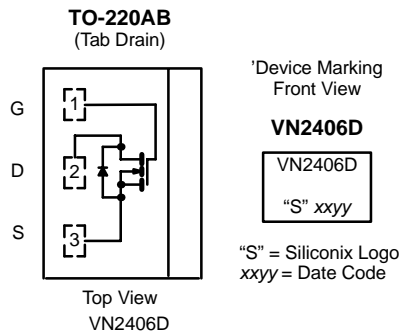
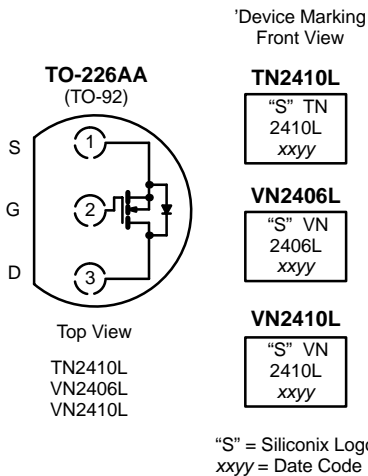

ABSOLUTE MAXIMUM RATINGS ($T_A = 25^\circ\text{C}$ UNLESS OTHERWISE NOTED)							
Parameter	Symbol	TN2410L	VN2406D ^b	VN2406L	VN2410L	VN2410LS	Unit
Drain-Source Voltage	V_{DS}	240	240	240	240	240	V
Gate-Source Voltage	V_{GS}	± 20	± 20	± 20	± 20	± 20	
Continuous Drain Current ($T_J = 150^\circ\text{C}$)	$T_A = 25^\circ\text{C}$	I_D	0.18	1.12	0.18	0.18	A
	$T_A = 100^\circ\text{C}$		0.11	0.7	0.11	0.11	
Pulsed Drain Current ^a	I_{DM}	1	3	1.7	1.7	2	
Power Dissipation	$T_A = 25^\circ\text{C}$	P_D	0.8	20	0.8	0.8	W
	$T_A = 100^\circ\text{C}$		0.32	8	0.32	0.32	
Thermal Resistance, Junction-to-Ambient	R_{thJA}	156	6.25 ^c	156	156	139	$^\circ\text{C/W}$
Operating Junction and Storage Temperature Range	T_J, T_{stg}	-55 to 150					$^\circ\text{C}$

Notes

- Pulse width limited by maximum junction temperature.
- Reference case for all temperature testing.
- Maximum junction-to-case

SPECIFICATIONS (T _A = 25 °C UNLESS OTHERWISE NOTED)										
Parameter	Symbol	Test Conditions	Typ ^a	Limits						Unit
				TN2410L		VN2406D/L		VN2410L/LS		
				Min	Max	Min	Max	Min	Max	
Static										
Drain-Source Breakdown Voltage	V _{(BR)DSS}	V _{GS} = 0 V, I _D = 100 μA	260	240		240		240		V
Gate-Threshold Voltage	V _{GS(th)}	V _{DS} = V _{GS} , I _D = 1 mA	1.4	0.5	1.8	0.8	2	0.8	2	
Gate-Body Leakage	I _{GSS}	V _{DS} = 0 V, V _{GS} = ±15 V					±100		±100	nA
		T _J = 125 °C					±500		±500	
Zero Gate Voltage Drain Current	I _{DSS}	V _{DS} = 192 V, V _{GS} = 0 V	0.01		1					μA
		T _J = 125 °C	1		100					
		V _{DS} = 120 V, V _{GS} = 0 V					10		10	
On-State Drain Current ^b	I _{D(on)}	V _{DS} = 10 V, V _{GS} = 4.5 V	0.8	0.25						A
		V _{DS} = 15 V, V _{GS} = 10 V	1.5			1		1		
Drain-Source On-Resistance ^b	r _{DS(on)}	V _{GS} = 2.5 V, I _D = 0.1 A	7.5				10		10	Ω
		V _{GS} = 3.5 V, I _D = 0.05 A	4.5		15					
		V _{GS} = 4.5 V, I _D = 0.2 A	4		10					
		T _J = 125 °C	7.5		20					
		V _{GS} = 10 V, I _D = 0.5 A	3.5				6		10	
Forward Transconductance ^b	g _{fs}	V _{DS} = 10 V, I _D = 0.2 A	500	100						mS
		V _{DS} = 10 V, I _D = 0.5 A	530			300		300		
Input Capacitance	C _{iss}	V _{DS} = 25 V, V _{GS} = 0 V f = 1 MHz	115		135		135		135	pF
Output Capacitance	C _{oss}		30		50		50		50	
Reverse Transfer Capacitance	C _{rss}		5		20		20		20	
Switching^c										
Turn-On Time	t _{ON}	V _{DD} = 60 V, R _L = 150 Ω I _D ≅ 0.4 A, V _{GEN} = 10 V R _G = 25 Ω	5		35					ns
	t _{d(on)}		3				8		8	
	t _r		2				8		8	
Turn-Off Time	t _{OFF}		26		60					
	t _{d(off)}		20				23		23	
	t _f		6				34		34	

Notes

- a. For DESIGN AID ONLY, not subject to production testing.
- b. Pulse test: PW ≤ 300 μs duty cycle ≤ 2%.
- c. Switching time is essentially independent of operating temperature.

VNDB24



TYPICAL CHARACTERISTICS ($T_A = 25^\circ\text{C}$ UNLESS OTHERWISE NOTED)

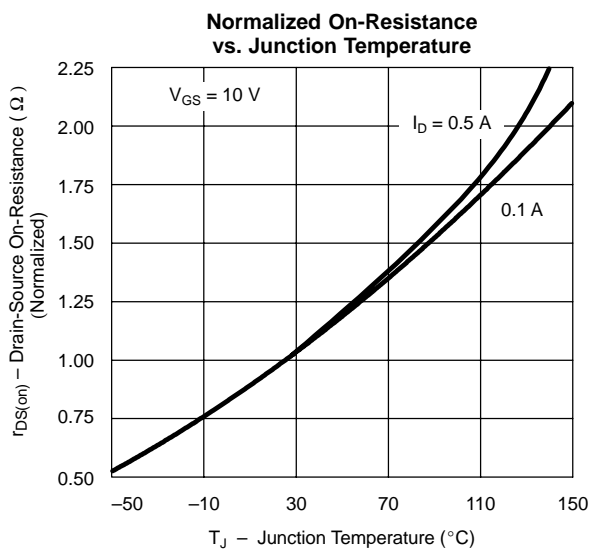
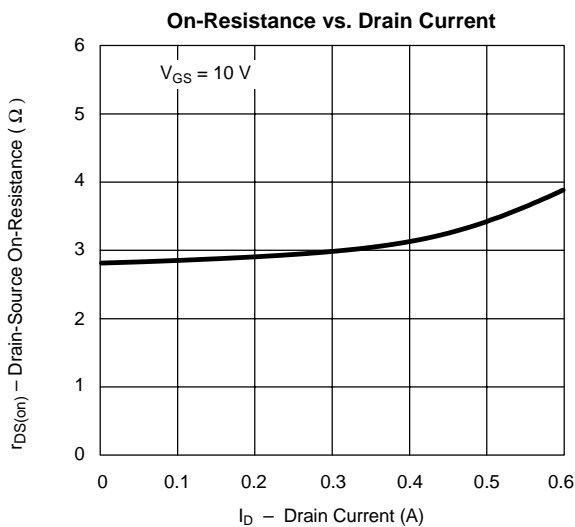
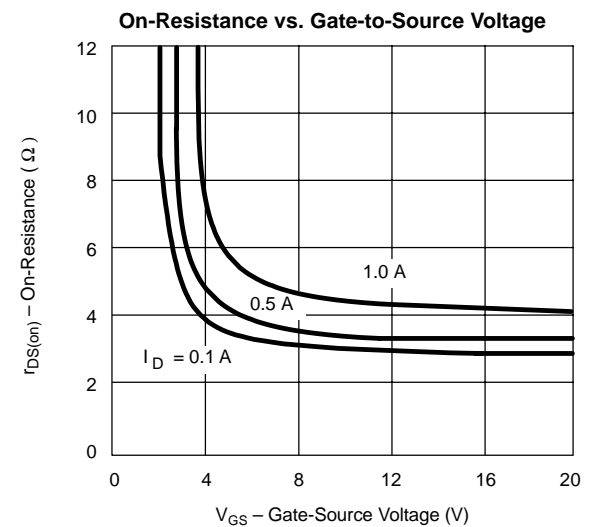
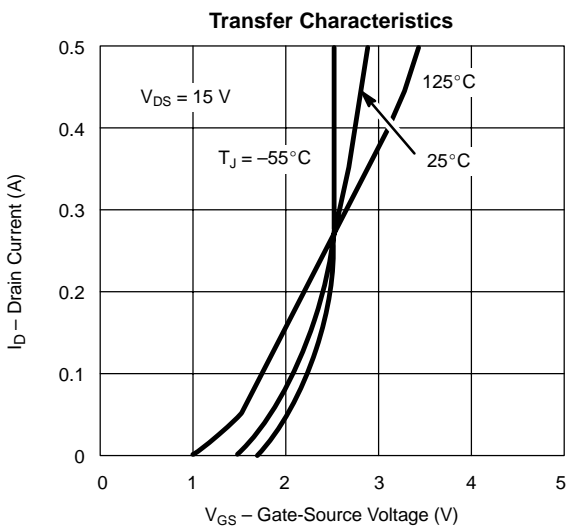
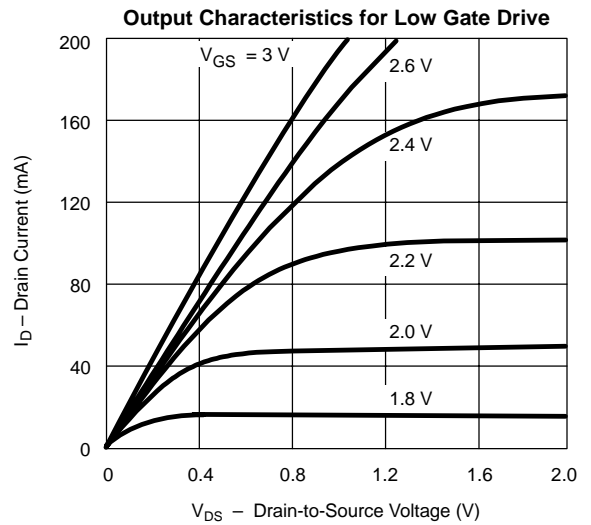
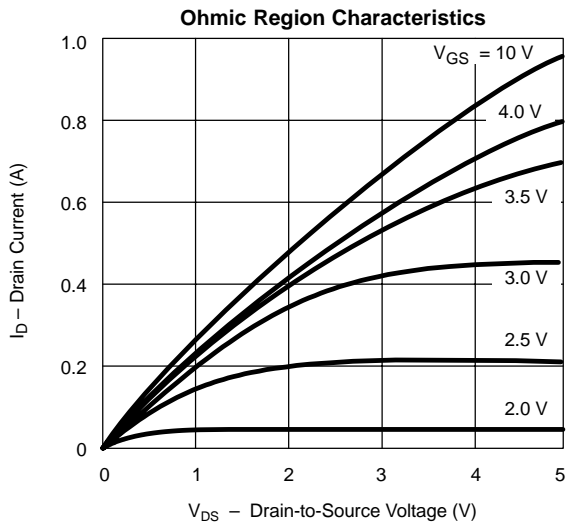

TYPICAL CHARACTERISTICS (T_A = 25 °C UNLESS OTHERWISE NOTED)

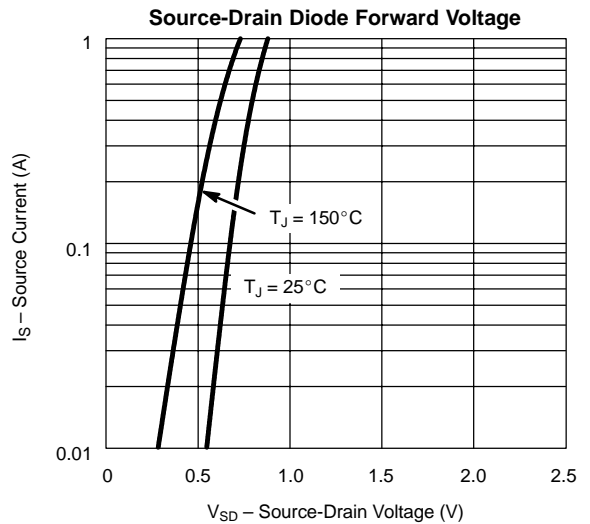
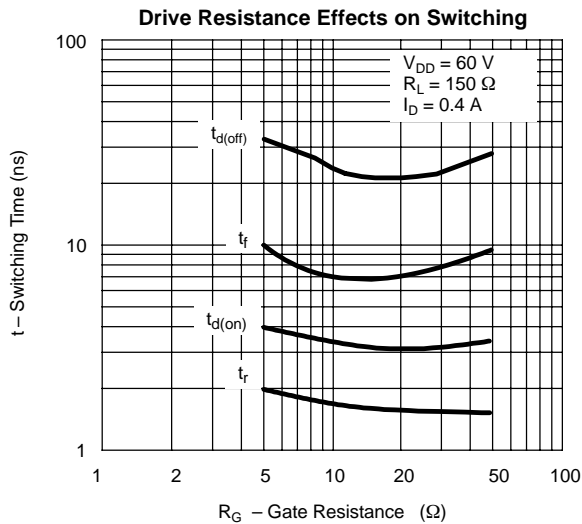
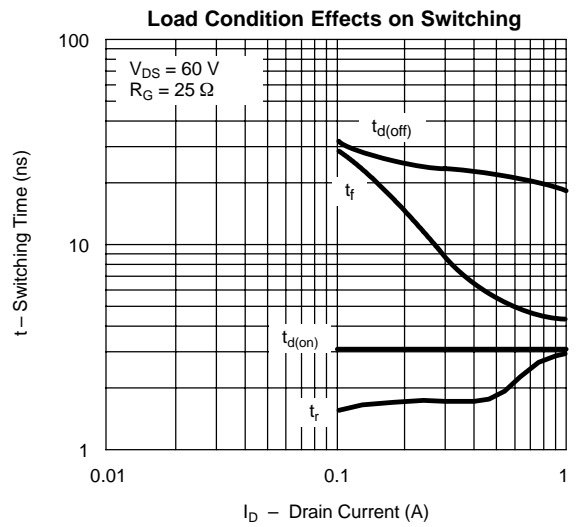
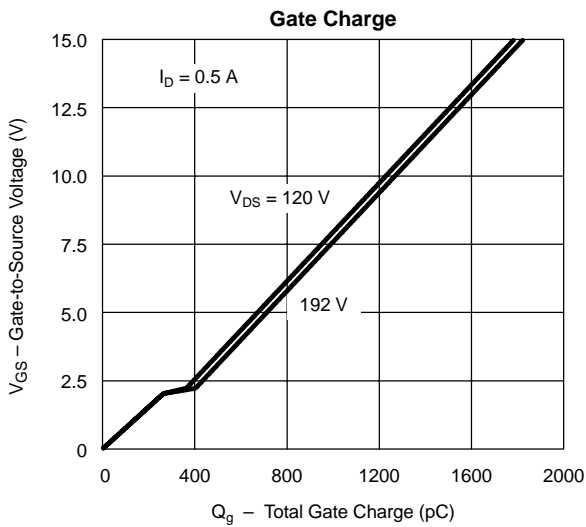
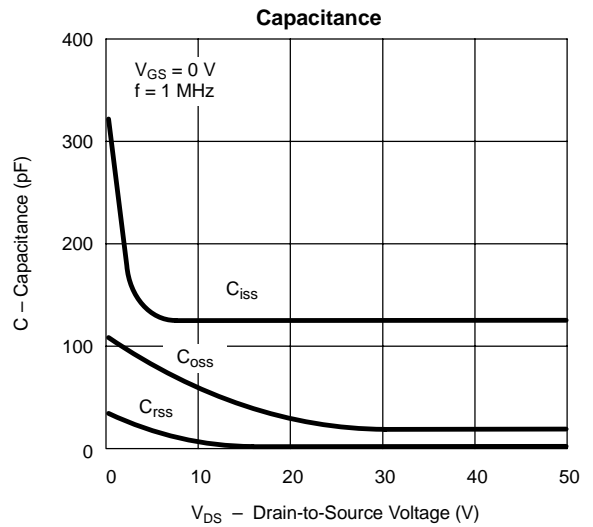
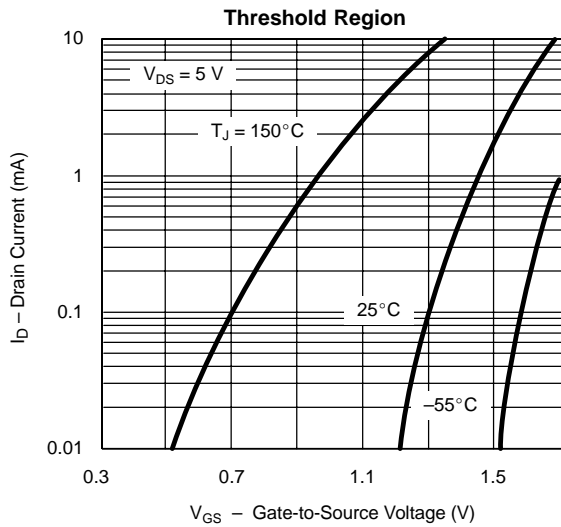



TYPICAL CHARACTERISTICS ($T_A = 25^\circ\text{C}$ UNLESS OTHERWISE NOTED)

