

NSBA114EF3T5G Series

Preferred Devices

Digital Transistors (BRT)

PNP Silicon Surface Mount Transistors with Monolithic Bias Resistor Network

This new series of digital transistors is designed to replace a single device and its external resistor bias network. The digital transistor contains a single transistor with a monolithic bias network consisting of two resistors; a series base resistor and a base-emitter resistor. The digital transistor eliminates these individual components by integrating them into a single device. The use of a digital transistor can reduce both system cost and board space. The device is housed in the SOT-1123 package which is designed for low power surface mount applications.

Features

- Simplifies Circuit Design
- Reduces Board Space
- Reduces Component Count
- The SOT-1123 Package can be Soldered using Wave or Reflow.
- Available in 4 mm, 8000 Unit Tape & Reel
- These are Pb-Free Devices
- These are Halide-Free Devices

MAXIMUM RATINGS ($T_A = 25^\circ\text{C}$ unless otherwise noted)

Rating	Symbol	Value	Unit
Collector-Base Voltage	V_{CBO}	50	Vdc
Collector-Emitter Voltage	V_{CEO}	50	Vdc
Collector Current	I_C	100	mAdc

Stresses exceeding Maximum Ratings may damage the device. Maximum Ratings are stress ratings only. Functional operation above the Recommended Operating Conditions is not implied. Extended exposure to stresses above the Recommended Operating Conditions may affect device reliability.



ON Semiconductor®

<http://onsemi.com>

PNP SILICON DIGITAL TRANSISTORS

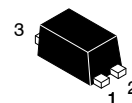
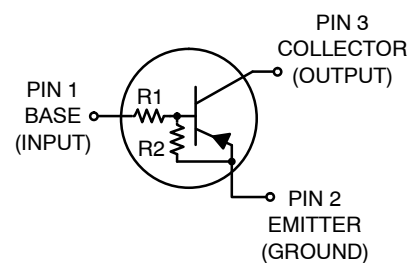

SOT-1123
CASE 524AA
STYLE 1

MARKING DIAGRAM

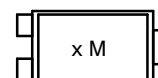

- x = Device Code
- M = Date Code
- G or ■ = Pb-Free Package

ORDERING INFORMATION

Device	Package	Shipping†
NSBA114EFT5G	SOT-1123 (Pb-Free)	8000/Tape & Reel

†For information on tape and reel specifications, including part orientation and tape sizes, please refer to our Tape and Reel Packaging Specifications Brochure, BRD8011/D.

DEVICE MARKING INFORMATION

See specific marking information in the device marking table on page 2 of this data sheet.

NSBA114EF3T5G Series

THERMAL CHARACTERISTICS

Characteristic	Symbol	Max	Unit
Total Device Dissipation $T_A = 25^\circ\text{C}$ (Note 1) Derate above 25°C	P_D	254 2.0	mW mW/ $^\circ\text{C}$
Thermal Resistance (Note 1) Junction-to-Ambient	$R_{\theta JA}$	493	$^\circ\text{C}/\text{W}$
Total Device Dissipation $T_A = 25^\circ\text{C}$ (Note 2) Derate above 25°C	P_D	297 2.4	mW mW/ $^\circ\text{C}$
Thermal Resistance (Note 2) Junction-to-Ambient	$R_{\theta JA}$	421	$^\circ\text{C}/\text{W}$
Thermal Resistance (Note 1) Junction-to-Lead 3	$R_{\theta JL}$	193	$^\circ\text{C}/\text{W}$
Junction and Storage Temperature	T_J, T_{stg}	-55 to +150	$^\circ\text{C}$

1. FR-4 @ 100 mm², 1 oz. copper traces, still air.
2. FR-4 @ 500 mm², 1 oz. copper traces, still air.

ORDERING INFORMATION, DEVICE MARKING AND RESISTOR VALUES

Device	Marking*	R1 (k)	R2 (k)	Package	Shipping†
NSBA114EF3T5G	F (0°)	10	10	SOT-1123 (Pb-Free)	8000 / Tape & Reel
NSBA124EF3T5G	Y (0°)	22	22		
NSBA144EF3T5G	E (0°)	47	47		
NSBA114YF3T5TG	K (0°)	10	47		
NSBA123TF3T5G	F (90°)	2.2	∞		
NSBA143EF3T5G	A (90°)	4.7	4.7		
NSBA143ZF3T5G	E (90°)	4.7	47		
NSBA123JF3T5G	J (90°)	2.2	47		
NSBA144WF3T5G	D (90°)	47	22		
NSBA114TF3T5G	L (90°)	10	∞		
NSBA115TF3T5G	Q (90°)	100	∞		

†For information on tape and reel specifications, including part orientation and tape sizes, please refer to our Tape and Reel Packaging Specification Brochure, BRD8011/D.

*(XX°) = Degree rotation in the clockwise direction.

NSBA114EF3T5G Series

ELECTRICAL CHARACTERISTICS ($T_A = 25^\circ\text{C}$ unless otherwise noted)

Characteristic	Symbol	Min	Typ	Max	Unit
OFF CHARACTERISTICS					
Collector–Base Cutoff Current ($V_{CB} = 50\text{ V}, I_E = 0$)	I_{CBO}	–	–	100	nAdc
Collector–Emitter Cutoff Current ($V_{CE} = 50\text{ V}, I_B = 0$)	I_{CEO}	–	–	500	nAdc
Emitter–Base Cutoff Current ($V_{EB} = 6.0\text{ V}, I_C = 0$)	I_{EBO}	–	–	0.5	mAdc
NSBA114EF3T5G		–	–	0.2	
NSBA124EF3T5G		–	–	0.1	
NSBA144EF3T5G		–	–	0.2	
NSBA114YF3T5G		–	–	4.0	
NSBA123TF3T5G		–	–	0.9	
NSBA114TF3T5G		–	–	1.5	
NSBA143EF3T5G		–	–	0.1	
NSBA115T53T5G		–	–	0.18	
NSBA143ZF3T5G		–	–	0.2	
NSBA123JF3T5G		–	–	0.13	
NSBA144WF3T5G		–	–		
Collector–Base Breakdown Voltage ($I_C = 10\ \mu\text{A}, I_E = 0$)	$V_{(BR)CBO}$	50	–	–	Vdc
Collector–Emitter Breakdown Voltage (Note 3) ($I_C = 2.0\text{ mA}, I_B = 0$)	$V_{(BR)CEO}$	50	–	–	Vdc
ON CHARACTERISTICS (Note 3)					
DC Current Gain ($V_{CE} = 10\text{ V}, I_C = 5.0\text{ mA}$)	h_{FE}	35	60	–	
NSBA114EF3T5G		60	100	–	
NSBA124EF3T5G		80	140	–	
NSBA144EF3T5G		80	140	–	
NSBA114YF3T5G		160	350	–	
NSBA115TF3T5G/NSBA123TF3T5G		15	27	–	
NSBA143EF3T5G		80	140	–	
NSBA143ZF3T5G		80	140	–	
NSBA123JF3T5G		80	140	–	
NSBA144WF3T5G		80	140	–	
NSBA114TF3T5G		160	250	–	
Collector–Emitter Saturation Voltage ($I_C = 10\text{ mA}, I_E = 0.3\text{ mA}$) NSBA114EF3T5G/NSBA124EF3T5G/NSBA144EF3T5G NSBA114YF3T5G/NSBA123TF3T5G/NSBA123JF3T5G NSBA144WF3T5G ($I_C = 10\text{ mA}, I_B = 1\text{ mA}$) NSBA143ZF3T5G/NSBA143EF3T5G/NSBA114TF3T5G ($I_C = 10\text{ mA}, I_B = 5\text{ mA}$) NSBA115TF3T5G	$V_{CE(sat)}$	–	–	0.25	Vdc
Output Voltage (on) ($V_{CC} = 5.0\text{ V}, V_B = 2.5\text{ V}, R_L = 1.0\text{ k}\Omega$)	V_{OL}	–	–	0.2	Vdc
NSBA114TF3T5G		–	–	0.2	
NSBA114EF3T5G		–	–	0.2	
NSBA124EF3T5G		–	–	0.2	
NSBA114YF3T5G		–	–	0.2	
NSBA123TF3T5G		–	–	0.2	
NSBA143EF3T5G		–	–	0.2	
NSBA143ZF3T5G		–	–	0.2	
NSBA123JF3T5G		–	–	0.2	
($V_{CC} = 5.0\text{ V}, V_B = 3.5\text{ V}, R_L = 1.0\text{ k}\Omega$)		–	–	0.2	
($V_{CC} = 5.0\text{ V}, V_B = 4.0\text{ V}, R_L = 1.0\text{ k}\Omega$)		–	–	0.2	
($V_{CC} = 5.0\text{ V}, V_B = 5.0\text{ V}, R_L = 1.0\text{ k}\Omega$)		–	–	0.2	
Output Voltage (off) ($V_{CC} = 5.0\text{ V}, V_B = 0.5\text{ V}, R_L = 1.0\text{ k}\Omega$) NSBA114EF3T5G/NSBA124EF3T5G/NSBA144EF3T5G NSBA114YF3T5G/NSBA143ZF3T5G/NSBA123JF3T5G NSBA144WF3T5G ($V_{CC} = 5.0\text{ V}, V_B = 0.25\text{ V}, R_L = 1.0\text{ k}\Omega$) NSBA123TF3T5G/NSBA143EF3T5G/NSBA114TF3T5G/ NSBA115TF3T5G	V_{OH}	4.9	–	–	Vdc

3. Pulse Test: Pulse Width < 300 μs , Duty Cycle < 2.0%

NSBA114EF3T5G Series

ELECTRICAL CHARACTERISTICS (T_A = 25°C unless otherwise noted) (Continued)

Characteristic	Symbol	Min	Typ	Max	Unit	
Input Resistor	R1	NSBA114TF3T5C	7.0	10	13	kΩ
		NSBA114EF3T5G	7.0	10	13	
		NSBA124EF3T5G	15.4	22	28.6	
		NSBA144EF3T5G	32.9	47	61.1	
		NSBA114YF3T5TG	7.0	10	13	
		NSBA123TF3T5G	1.5	2.2	2.9	
		NSBA143EF3T5G	3.3	4.7	6.1	
		NSBA143ZF3T5G	3.3	4.7	6.1	
		NSBA123JF3T5G	1.54	2.2	2.86	
		NSBA144WF3T5G	32.9	47	61.1	
		NSBA115TF3T5G	70	100	130	
Resistor Ratio	R ₁ /R ₂	NSBA114EF3T5G/NSBA124EF3T5G/ NSBA144EF3T5G/NSBA143EF3T5G	0.8	1.0	1.2	
		NSBA114YF3T5TG	0.17	0.21	0.25	
		NSBA123TF3T5G/NSBA114TF3T5G/ NSBA115TF3T5G	–	–	–	
		NSBA143ZF3T5G	0.055	0.1	0.185	
		NSBA123JF3T5G	0.038	0.047	0.056	
		NSBA144WF3T5G	1.7	2.1	2.6	

NSBA114EF3T5G Series

TYPICAL ELECTRICAL CHARACTERISTICS – NSBA114EF3T5G

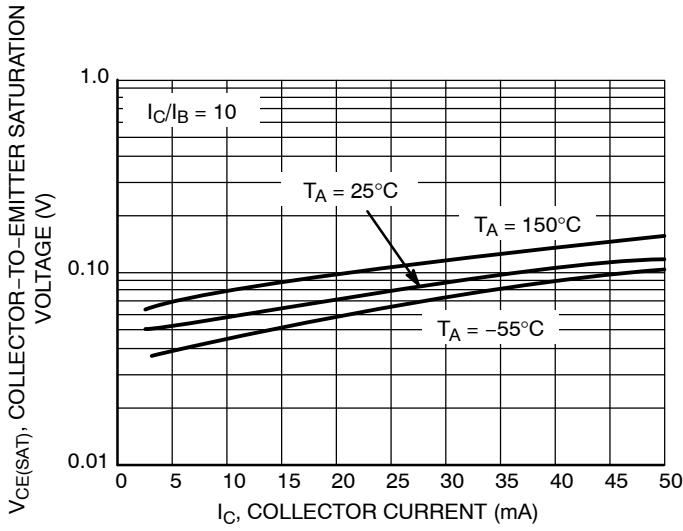

Figure 1. $V_{CE(sat)}$ vs. I_C

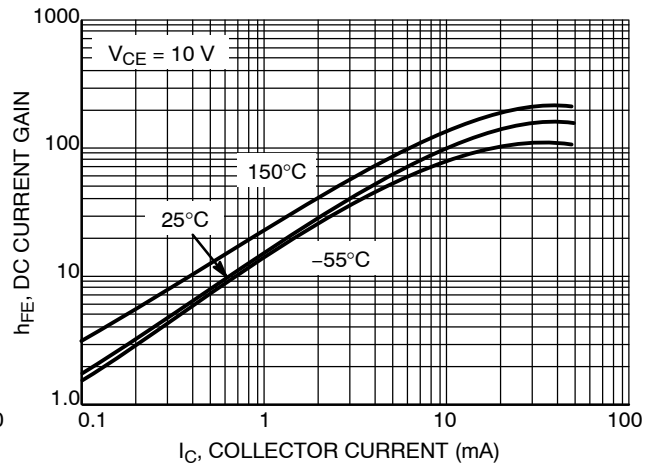

Figure 2. DC Current Gain

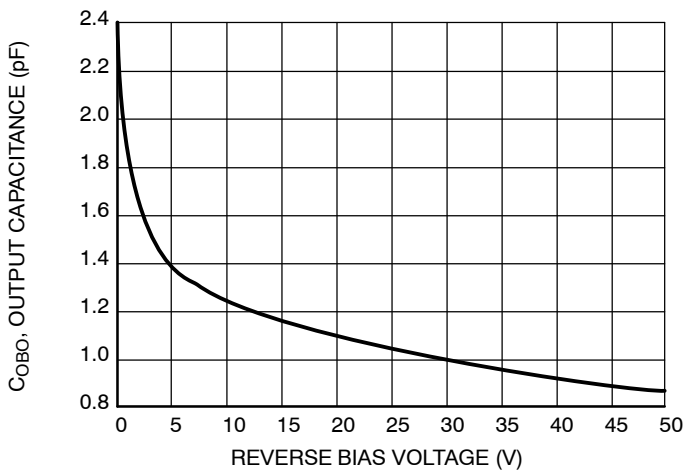

Figure 3. Output Capacitance

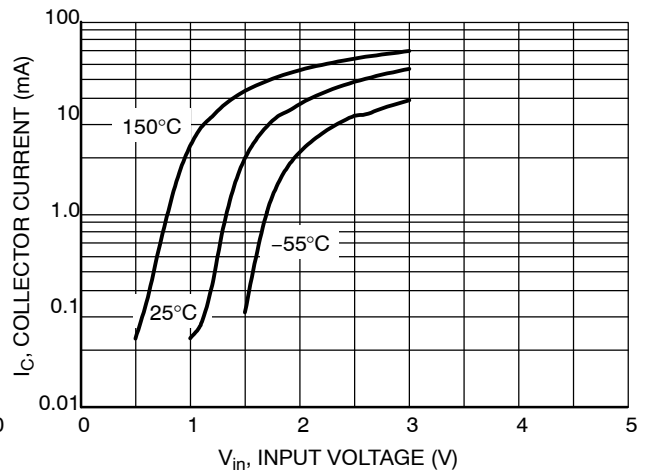

Figure 4. Output Current vs. Input Voltage

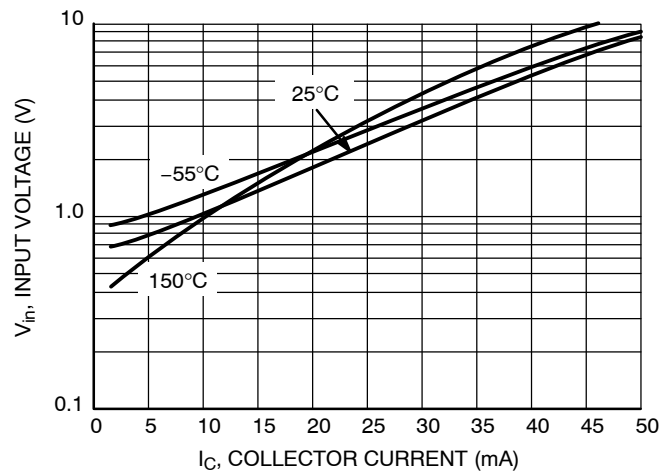
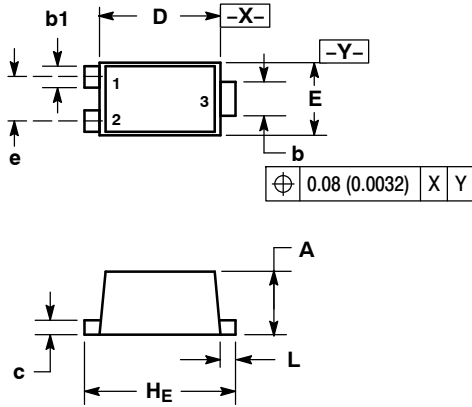

Figure 5. Input Voltage vs. Output Current

NSBA114EF3T5G Series

PACKAGE DIMENSIONS

SOT-1123
CASE 524AA-01
ISSUE B



NOTES:

1. DIMENSIONING AND TOLERANCING PER ANSI Y14.5M, 1982.
2. CONTROLLING DIMENSION: MILLIMETERS.
3. MAXIMUM LEAD THICKNESS INCLUDES LEAD FINISH THICKNESS. MINIMUM LEAD THICKNESS IS THE MINIMUM THICKNESS OF BASE MATERIAL.

DIM	MILLIMETERS			INCHES		
	MIN	NOM	MAX	MIN	NOM	MAX
A	0.34	0.37	0.40	0.013	0.015	0.016
b	0.15	0.22	0.28	0.006	0.009	0.011
b1	0.10	0.15	0.20	0.004	0.006	0.008
c	0.07	0.12	0.17	0.003	0.005	0.007
D	0.75	0.80	0.85	0.030	0.031	0.033
E	0.55	0.60	0.65	0.022	0.024	0.026
e	0.35	---	0.40	0.014	---	0.016
HE	0.95	1.00	1.05	0.037	0.039	0.041
L	0.05	0.10	0.15	0.002	0.004	0.006

STYLE 1:

1. BASE
2. EMITTER
3. COLLECTOR

SOLDERING FOOTPRINT*

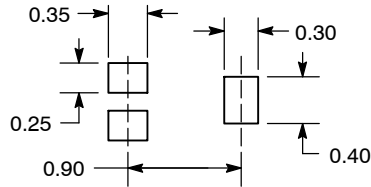

DIMENSIONS: MILLIMETERS

*For additional information on our Pb-Free strategy and soldering details, please download the ON Semiconductor Soldering and Mounting Techniques Reference Manual, SOLDERRM/D.

ON Semiconductor and are registered trademarks of Semiconductor Components Industries, LLC (SCILLC). SCILLC reserves the right to make changes without further notice to any products herein. SCILLC makes no warranty, representation or guarantee regarding the suitability of its products for any particular purpose, nor does SCILLC assume any liability arising out of the application or use of any product or circuit, and specifically disclaims any and all liability, including without limitation special, consequential or incidental damages. "Typical" parameters which may be provided in SCILLC data sheets and/or specifications can and do vary in different applications and actual performance may vary over time. All operating parameters, including "Typicals" must be validated for each customer application by customer's technical experts. SCILLC does not convey any license under its patent rights nor the rights of others. SCILLC products are not designed, intended, or authorized for use as components in systems intended for surgical implant into the body, or other applications intended to support or sustain life, or for any other application in which the failure of the SCILLC product could create a situation where personal injury or death may occur. Should Buyer purchase or use SCILLC products for any such unintended or unauthorized application, Buyer shall indemnify and hold SCILLC and its officers, employees, subsidiaries, affiliates, and distributors harmless against all claims, costs, damages, and expenses, and reasonable attorney fees arising out of, directly or indirectly, any claim of personal injury or death associated with such unintended or unauthorized use, even if such claim alleges that SCILLC was negligent regarding the design or manufacture of the part. SCILLC is an Equal Opportunity/Affirmative Action Employer. This literature is subject to all applicable copyright laws and is not for resale in any manner.

PUBLICATION ORDERING INFORMATION

LITERATURE FULFILLMENT:

Literature Distribution Center for ON Semiconductor
P.O. Box 5163, Denver, Colorado 80217 USA
Phone: 303-675-2175 or 800-344-3860 Toll Free USA/Canada
Fax: 303-675-2176 or 800-344-3867 Toll Free USA/Canada
Email: orderlit@onsemi.com

N. American Technical Support: 800-282-9855 Toll Free
USA/Canada
Europe, Middle East and Africa Technical Support:
Phone: 421 33 790 2910
Japan Customer Focus Center
Phone: 81-3-5773-3850

ON Semiconductor Website: www.onsemi.com

Order Literature: <http://www.onsemi.com/orderlit>

For additional information, please contact your local Sales Representative

Mouser Electronics

Authorized Distributor

Click to View Pricing, Inventory, Delivery & Lifecycle Information:

ON Semiconductor:

[NSBA114EF3T5G](#) [NSBA144EF3T5G](#) [NSBA114TF3T5G](#) [NSBA115TF3T5G](#) [NSBA123JF3T5G](#) [NSBA123TF3T5G](#)
[NSBA114YF3T5G](#) [NSBA124EF3T5G](#) [NSBA143EF3T5G](#) [NSBA143ZF3T5G](#) [NSBA144WF3T5G](#)