

# MMUN2211LT1G Series, SMMUN2211LT1G Series, NSVMMUN2232LT1G



ON Semiconductor®

<http://onsemi.com>

## Bias Resistor Transistor NPN Silicon Surface Mount Transistor with Monolithic Bias Resistor Network

This new series of digital transistors is designed to replace a single device and its external resistor bias network. The BRT (Bias Resistor Transistor) contains a single transistor with a monolithic bias network consisting of two resistors; a series base resistor and a base-emitter resistor. The BRT eliminates these individual components by integrating them into a single device. The use of a BRT can reduce both system cost and board space. The device is housed in the SOT-23 package which is designed for low power surface mount applications.

### Features

- Simplifies Circuit Design
- Reduces Board Space and Component Count
- AEC-Q101 Qualified and PPAP Capable
- S, NSV Prefix for Automotive and Other Applications Requiring Unique Site and Control Change Requirements
- These Devices are Pb-Free, Halogen Free/BFR Free and are RoHS Compliant

### MAXIMUM RATINGS (T<sub>A</sub> = 25°C unless otherwise noted)

Rating	Symbol	Value	Unit
Collector-Base Voltage	V <sub>CBO</sub>	50	Vdc
Collector-Emitter Voltage	V <sub>CEO</sub>	50	Vdc
Collector Current	I <sub>C</sub>	100	mAdc

### THERMAL CHARACTERISTICS

Characteristic	Symbol	Max	Unit
Total Device Dissipation T <sub>A</sub> = 25°C Derate above 25°C	P <sub>D</sub>	246 (Note 1) 400 (Note 2) 1.5 (Note 1) 2.0 (Note 2)	mW °C/W
Thermal Resistance, Junction-to-Ambient	R <sub>θJA</sub>	508 (Note 1) 311 (Note 2)	°C/W
Thermal Resistance, Junction-to-Lead	R <sub>θJL</sub>	174 (Note 1) 208 (Note 2)	°C/W
Junction and Storage Temperature Range	T <sub>J</sub> , T <sub>stg</sub>	-55 to +150	°C

Stresses exceeding Maximum Ratings may damage the device. Maximum Ratings are stress ratings only. Functional operation above the Recommended Operating Conditions is not implied. Extended exposure to stresses above the Recommended Operating Conditions may affect device reliability.

1. FR-4 @ minimum pad
2. FR-4 @ 1.0 x 1.0 inch pad

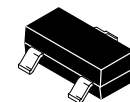
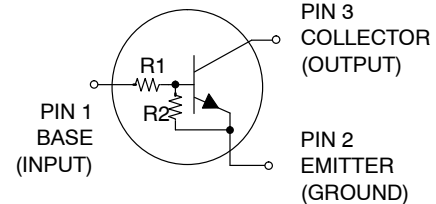

SOT-23  
CASE 318  
STYLE 6

### MARKING DIAGRAM

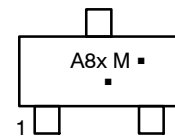

A8x = Specific Device

Code

M = Date Code\*

(Note: Microdot may be used for marking)

\*Date Code orientation and/or overbar may vary depending upon manufacturing location.

### ORDERING INFORMATION

See detailed ordering and shipping information in the package dimensions section on page 17 of this data sheet.

# MMUN2211LT1G Series, SMMUN2211LT1G Series, NSVMMUN2232LT1G

## ELECTRICAL CHARACTERISTICS (T<sub>A</sub> = 25°C unless otherwise noted)

Characteristic	Symbol	Min	Typ	Max	Unit
<b>OFF CHARACTERISTICS</b>					
Collector–Base Cutoff Current (V <sub>CB</sub> = 50 V, I <sub>E</sub> = 0)	I <sub>CBO</sub>	–	–	100	nAdc
Collector–Emitter Cutoff Current (V <sub>CE</sub> = 50 V, I <sub>B</sub> = 0)	I <sub>CEO</sub>	–	–	500	nAdc
Emitter–Base Cutoff Current (V <sub>EB</sub> = 6.0 V, I <sub>C</sub> = 0)	I <sub>EBO</sub>	–	–	0.5	mAdc
MMUN2211LT1G, SMMUN2211LT1G		–	–	0.2	
MMUN2212LT1G		–	–	0.1	
MMUN2213LT1G, SMMUN2213LT1G, SMMUN2213LT3G		–	–	0.2	
MMUN2214LT1G, SMMUN2214LT1G		–	–	0.9	
MMUN2215LT1G, SMMUN2215LT1G		–	–	1.9	
MMUN2216LT1G, SMMUN2216LT1G, SMMUN2216LT3G		–	–	4.3	
MMUN2230LT1G		–	–	2.3	
MMUN2231LT1G		–	–	1.5	
MMUN2232LT1G, NSVMMUN2232LT1G		–	–	0.18	
MMUN2233LT1G, SMMUN2233LT1G		–	–	0.13	
MMUN2234LT1G, SMMUN2234LT1G		–	–	4.0	
MMUN2238LT1G		–	–	0.1	
MMUN2241LT1G		–	–		
Collector–Base Breakdown Voltage (I <sub>C</sub> = 10 μA, I <sub>E</sub> = 0)	V <sub>(BR)CBO</sub>	50	–	–	Vdc
Collector–Emitter Breakdown Voltage (Note 3), (I <sub>C</sub> = 2.0 mA, I <sub>B</sub> = 0)	V <sub>(BR)CEO</sub>	50	–	–	Vdc

## ON CHARACTERISTICS (Note 3)

DC Current Gain (V <sub>CE</sub> = 10 V, I <sub>C</sub> = 5.0 mA)	h <sub>FE</sub>	35	60	–	
MMUN2211LT1G, SMMUN2211LT1G		60	100	–	
MMUN2212LT1G		80	140	–	
MMUN2213LT1G, SMMUN2213LT1G, SMMUN2213LT3G		80	140	–	
MMUN2214LT1G, SMMUN2214LT1G		160	350	–	
MMUN2215LT1G, SMMUN2215LT1G		160	350	–	
MMUN2216LT1G, SMMUN2216LT1G, SMMUN2216LT3G		3.0	5.0	–	
MMUN2230LT1G		8.0	15	–	
MMUN2231LT1G		15	30	–	
MMUN2232LT1G, NSVMMUN2232LT1G		80	200	–	
MMUN2233LT1G, SMMUN2233LT1G		80	150	–	
MMUN2234LT1G, SMMUN2234LT1G		160	350	–	
MMUN2238LT1G		160	350	–	
MMUN2241LT1G				–	
Collector–Emitter Saturation Voltage (I <sub>C</sub> = 10 mA, I <sub>B</sub> = 0.3 mA)	V <sub>CE(sat)</sub>	–	–	0.25	Vdc
MMUN2211LT1G, SMMUN2211LT1G		–	–	0.25	
MMUN2212LT1G		–	–	0.25	
MMUN2213LT1G, SMMUN2213LT1G, SMMUN2213LT3G		–	–	0.25	
MMUN2214LT1G, SMMUN2214LT1G		–	–	0.25	
MMUN2233LT1G, SMMUN2233LT1G		–	–	0.25	
MMUN2234LT1G, SMMUN2234LT1G		–	–	0.25	
(I <sub>C</sub> = 10 mA, I <sub>B</sub> = 1 mA)		–	–	0.25	
MMUN2215LT1G, SMMUN2215LT1G		–	–	0.25	
MMUN2216LT1G, SMMUN2216LT1G, SMMUN2216LT3G		–	–	0.25	
MMUN2232LT1G, NSVMMUN2232LT1G		–	–	0.25	
MMUN2238LT1G		–	–	0.25	
(I <sub>C</sub> = 10 mA, I <sub>B</sub> = 5 mA)		–	–	0.25	
MMUN2230LT1G		–	–	0.25	
MMUN2231LT1G		–	–	0.25	
MMUN2241LT1G		–	–	0.25	

3. Pulse Test: Pulse Width < 300 μs, Duty Cycle < 2.0%.

# MMUN2211LT1G Series, SMMUN2211LT1G Series, NSVMMUN2232LT1G

## ELECTRICAL CHARACTERISTICS (T<sub>A</sub> = 25°C unless otherwise noted) (Continued)

Characteristic	Symbol	Min	Typ	Max	Unit
<b>ON CHARACTERISTICS</b> (Note 4)					
Output Voltage (on) (V <sub>CC</sub> = 5.0 V, V <sub>B</sub> = 2.5 V, R <sub>L</sub> = 1.0 kΩ)	V <sub>OL</sub>				Vdc
MMUN2211LT1G, SMMUN2211LT1G		-	-	0.2	
MMUN2212LT1G		-	-	0.2	
MMUN2214LT1G, SMMUN2214LT1G		-	-	0.2	
MMUN2215LT1G, SMMUN2215LT1G		-	-	0.2	
MMUN2216LT1G, SMMUN2216LT1G, SMMUN2216LT3G		-	-	0.2	
MMUN2230LT1G		-	-	0.2	
MMUN2231LT1G		-	-	0.2	
MMUN2232LT1G, NSVMMUN2232LT1G		-	-	0.2	
MMUN2233LT1G, SMMUN2233LT1G		-	-	0.2	
MMUN2234LT1G, SMMUN2234LT1G		-	-	0.2	
MMUN2238LT1G		-	-	0.2	
(V <sub>CC</sub> = 5.0 V, V <sub>B</sub> = 3.5 V, R <sub>L</sub> = 1.0 kΩ)					
MMUN2213LT1G, SMMUN2213LT1G, SMMUN2213LT3G		-	-	0.2	
(V <sub>CC</sub> = 5.0 V, V <sub>B</sub> = 5.0 V, R <sub>L</sub> = 1.0 kΩ)		-	-	0.2	
MMUN2241LT1G		-	-	0.2	
Output Voltage (off) (V <sub>CC</sub> = 5.0 V, V <sub>B</sub> = 0.5 V, R <sub>L</sub> = 1.0 kΩ)	V <sub>OH</sub>				Vdc
MMUN2211LT1G, SMMUN2211LT1G		4.9	-	-	
MMUN2212LT1G		4.9	-	-	
MMUN2213LT1G, SMMUN2213LT1G, SMMUN2213LT3G		4.9	-	-	
MMUN2214LT1G, SMMUN2214LT1G		4.9	-	-	
MMUN2233LT1G, SMMUN2233LT1G		4.9	-	-	
(V <sub>CC</sub> = 5.0 V, V <sub>B</sub> = 0.05 V, R <sub>L</sub> = 1.0 kΩ)		4.9	-	-	
MMUN2230LT1G		4.9	-	-	
MMUN2234LT1G, SMMUN2234LT1G		4.9	-	-	
(V <sub>CC</sub> = 5.0 V, V <sub>B</sub> = 0.25 V, R <sub>L</sub> = 1.0 kΩ)					
MMUN2215LT1G, SMMUN2215LT1G		4.9	-	-	
MMUN2216LT1G, SMMUN2216LT1G, SMMUN2216LT3G		4.9	-	-	
MMUN2231LT1G		4.9	-	-	
MMUN2232LT1G, NSVMMUN2232LT1G		4.9	-	-	
MMUN2238LT1G		4.9	-	-	
MMUN2241LT1G		4.9	-	-	
Input Resistor	R1				kΩ
MMUN2211LT1G, SMMUN2211LT1G		7.0	10	13	
MMUN2212LT1G		15.4	22	28.6	
MMUN2213LT1G, SMMUN2213LT1G, SMMUN2213LT3G		32.9	47	61.1	
MMUN2214LT1G, SMMUN2214LT1G		7.0	10	13	
MMUN2215LT1G, SMMUN2215LT1G		7.0	10	13	
MMUN2216LT1G, SMMUN2216LT1G, SMMUN2216LT3G		3.3	4.7	6.1	
MMUN2230LT1G		0.7	1.0	1.3	
MMUN2231LT1G		1.5	2.2	2.9	
MMUN2232LT1G, NSVMMUN2232LT1G		3.3	4.7	6.1	
MMUN2233LT1G, SMMUN2233LT1G		3.3	4.7	6.1	
MMUN2234LT1G, SMMUN2234LT1G		15.4	22	28.6	
MMUN2238LT1G		1.54	2.2	2.88	
MMUN2241LT1G		70	100	130	
Resistor Ratio	R1/R2				
MMUN2211LT1G, SMMUN2211LT1G		0.8	1.0	1.2	
MMUN2212LT1G		0.8	1.0	1.2	
MMUN2213LT1G, SMMUN2213LT1G, SMMUN2213LT3G		0.8	1.0	1.2	
MMUN2214LT1G, SMMUN2214LT1G		0.17	0.21	0.25	
MMUN2215LT1G, SMMUN2215LT1G		-	-	-	
MMUN2216LT1G, SMMUN2216LT1G, SMMUN2216LT3G		-	-	-	
MMUN2230LT1G		0.8	1.0	1.2	
MMUN2231LT1G		0.8	1.0	1.2	
MMUN2232LT1G, NSVMMUN2232LT1G		0.8	1.0	1.2	
MMUN2233LT1G, SMMUN2233LT1G		0.055	0.1	0.185	
MMUN2234LT1G, SMMUN2234LT1G		0.38	0.47	0.56	
MMUN2238LT1G		-	-	-	
MMUN2241LT1G		-	-	-	

4. Pulse Test: Pulse Width < 300 μs, Duty Cycle < 2.0%.

TYPICAL ELECTRICAL CHARACTERISTICS – MMUN2211LT1G, SMMUN2211LT1G

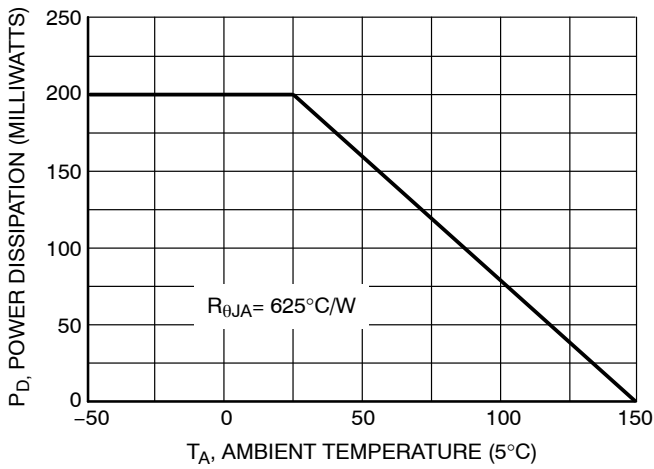

Figure 1. Derating Curve

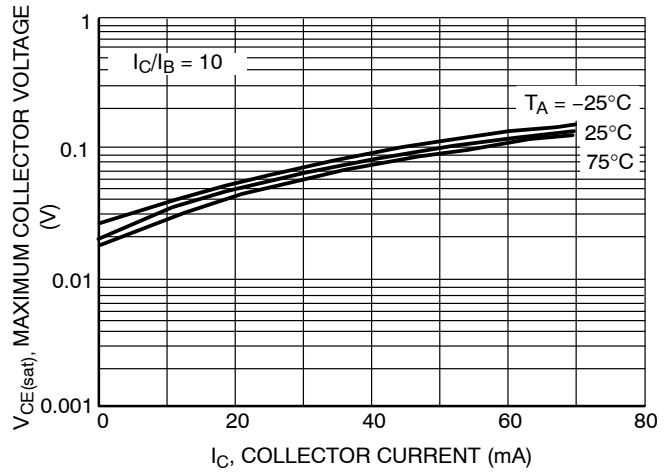

Figure 2. V<sub>CE(sat)</sub> vs. I<sub>C</sub>

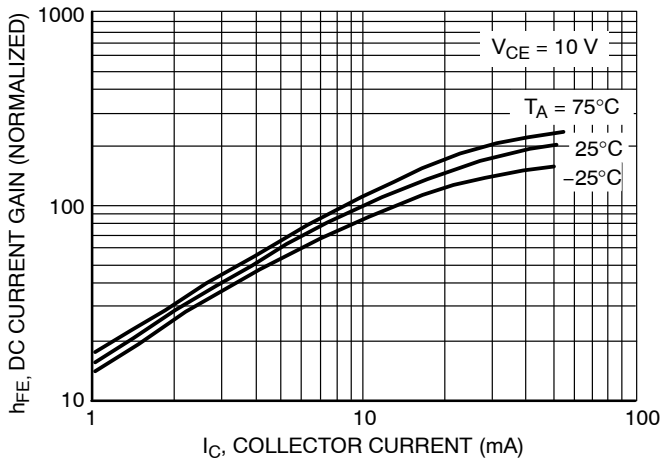

Figure 3. DC Current Gain

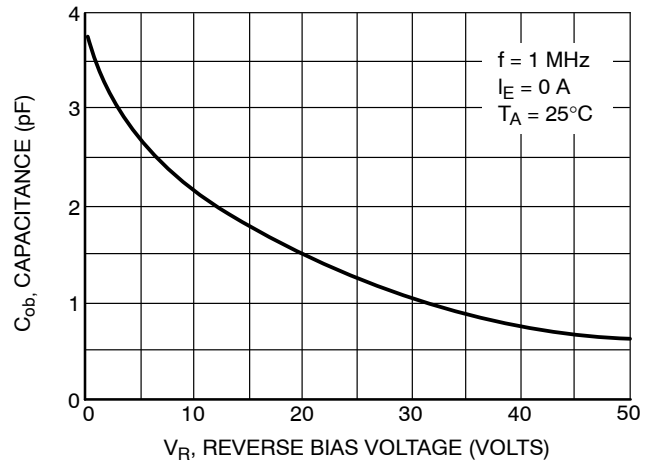

Figure 4. Output Capacitance

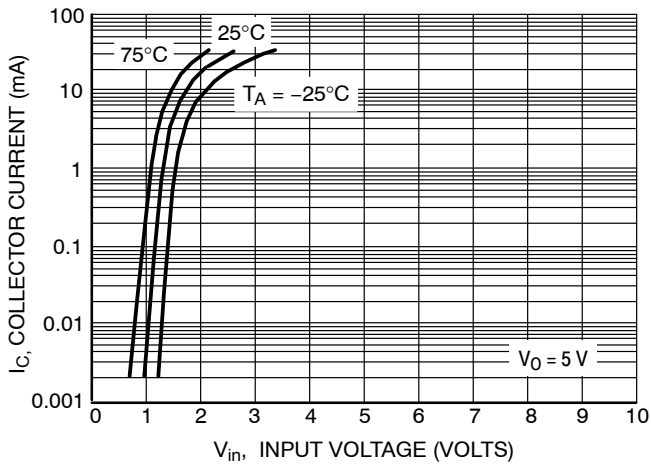

Figure 5. Output Current vs. Input Voltage

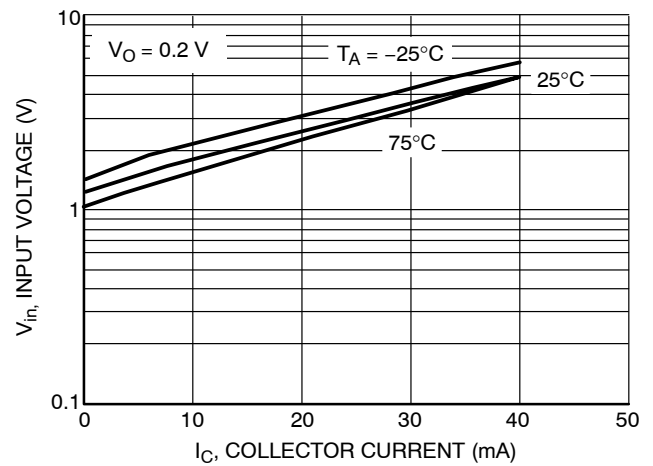

Figure 6. Input Voltage vs. Output Current

TYPICAL ELECTRICAL CHARACTERISTICS – MMUN2212LT1G

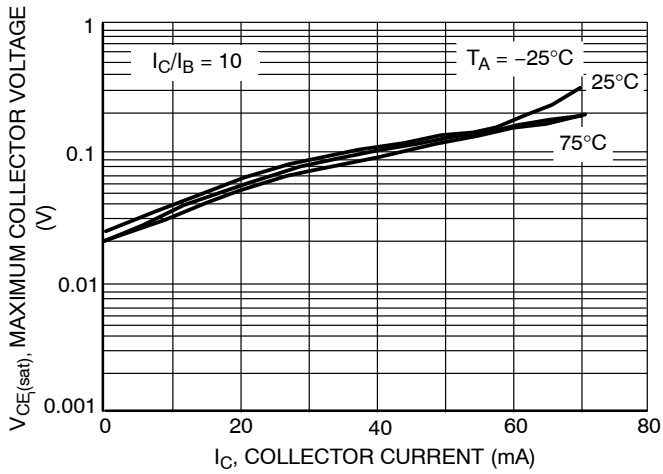

Figure 7.  $V_{CE(sat)}$  vs.  $I_C$

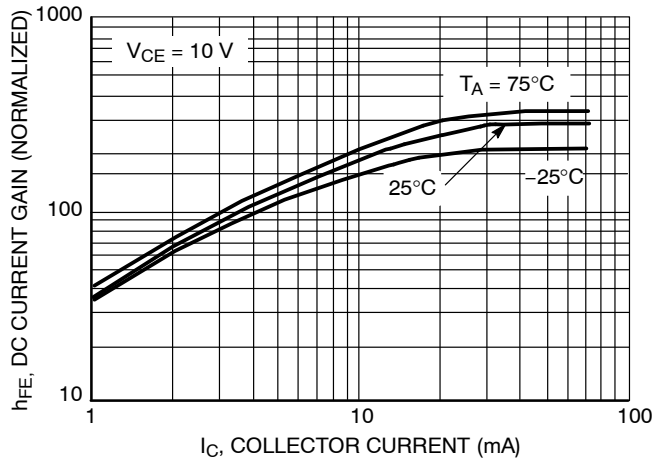

Figure 8. DC Current Gain

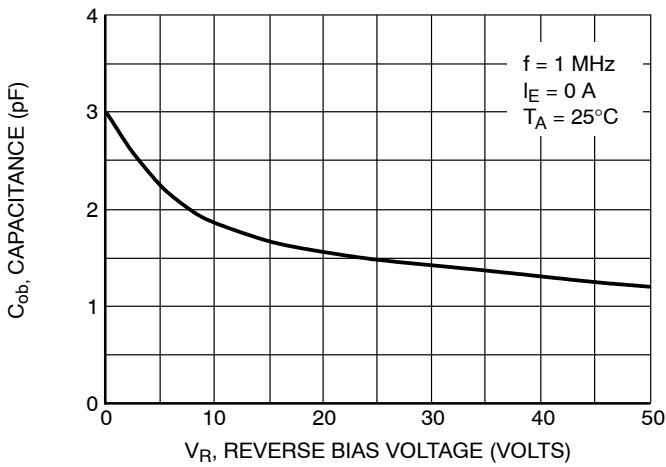

Figure 9. Output Capacitance

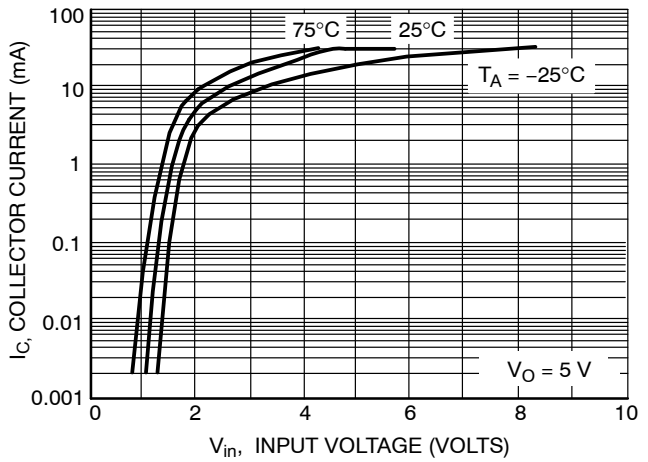

Figure 10. Output Current vs. Input Voltage

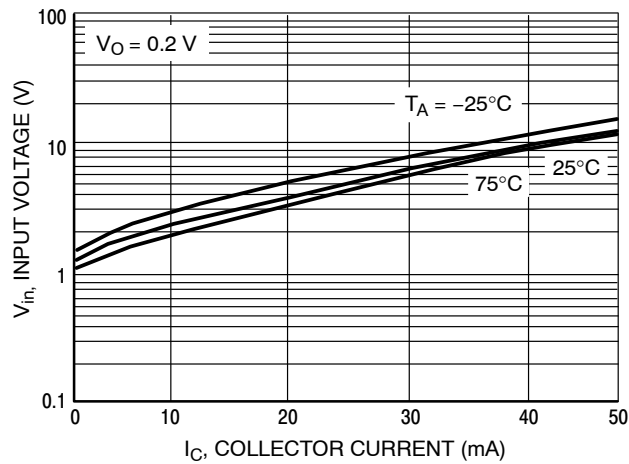

Figure 11. Input Voltage vs. Output Current

TYPICAL ELECTRICAL CHARACTERISTICS – MMUN2213LT1G, SMMUN2213LT1G Series

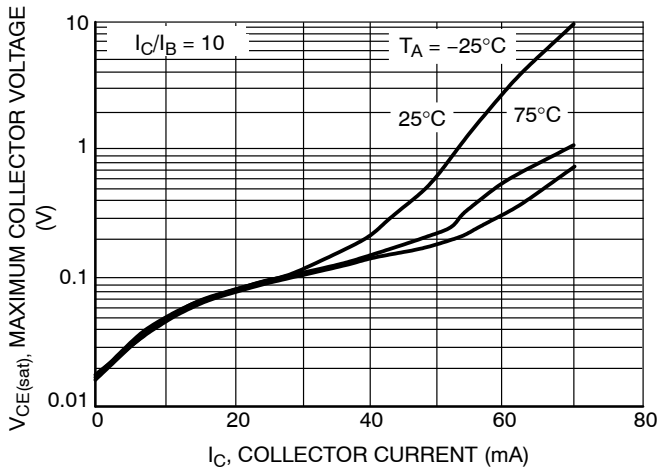

Figure 12.  $V_{CE(sat)}$  vs.  $I_C$

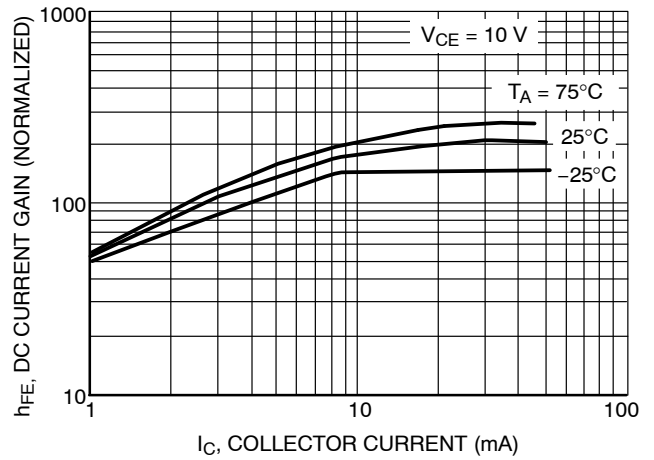

Figure 13. DC Current Gain

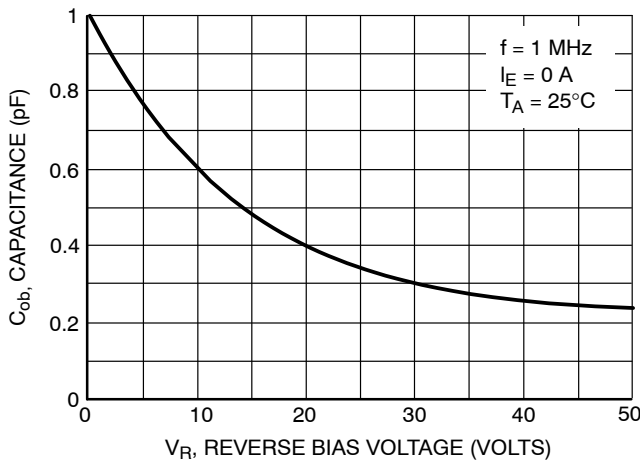

Figure 14. Output Capacitance

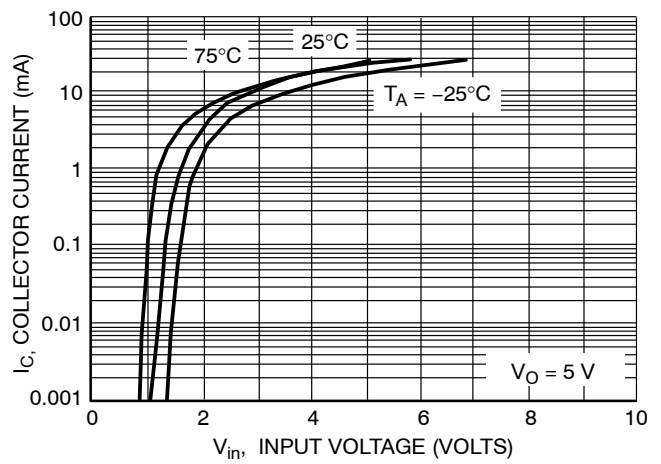

Figure 15. Output Current vs. Input Voltage

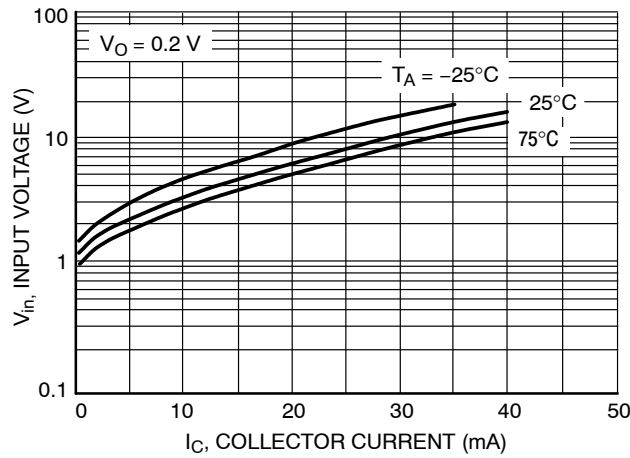

Figure 16. Input Voltage vs. Output Current

TYPICAL ELECTRICAL CHARACTERISTICS – MMUN2214LT1G, SMMUN2214LT1G

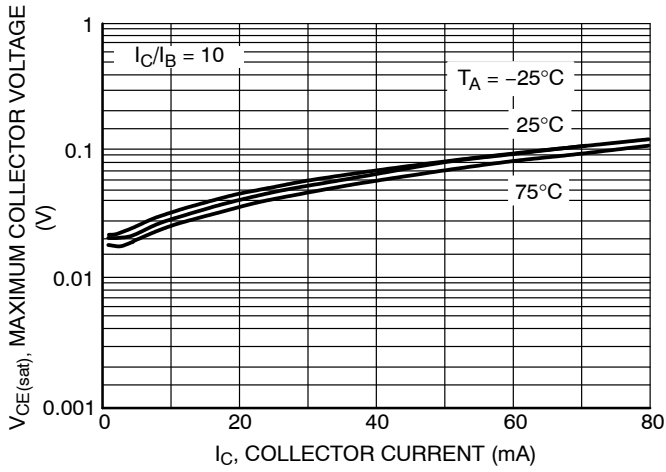

Figure 17.  $V_{CE(sat)}$  vs.  $I_C$

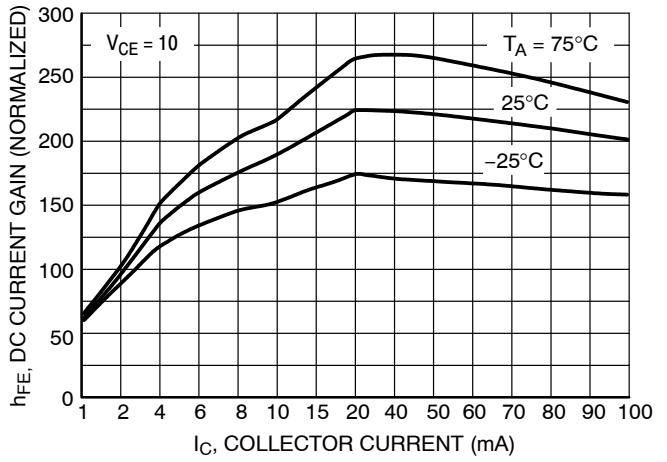

Figure 18. DC Current Gain

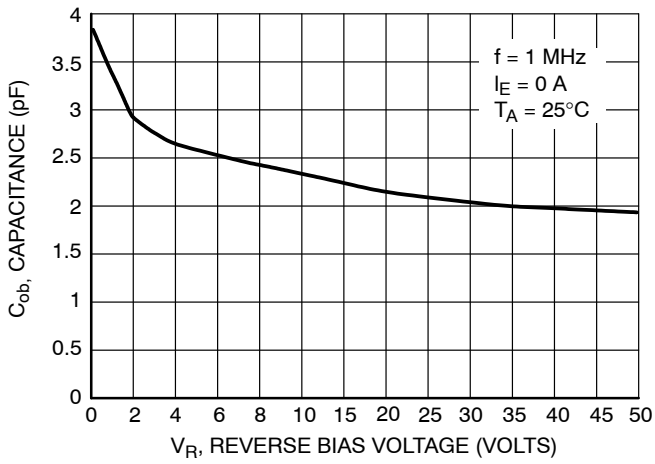

Figure 19. Output Capacitance

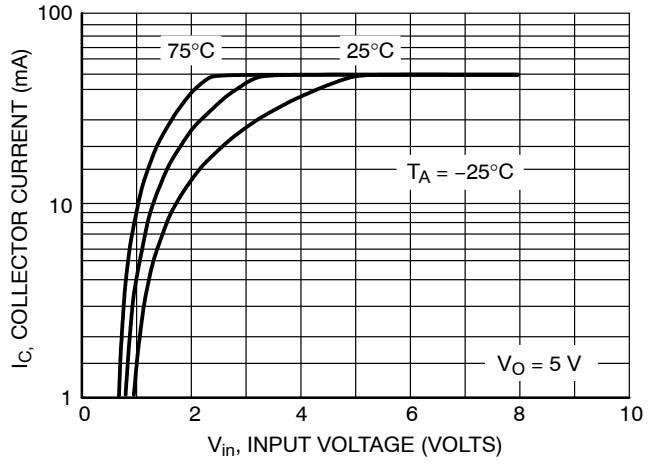

Figure 20. Output Current vs. Input Voltage

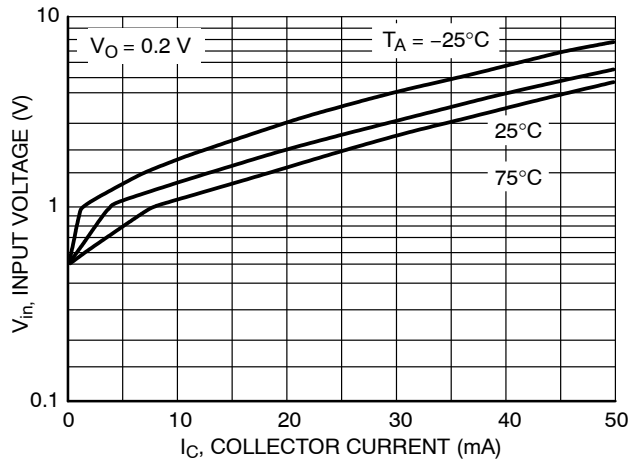

Figure 21. Input Voltage vs. Output Current

TYPICAL ELECTRICAL CHARACTERISTICS – MMUN2215LT1G, SMMUN2215LT1G

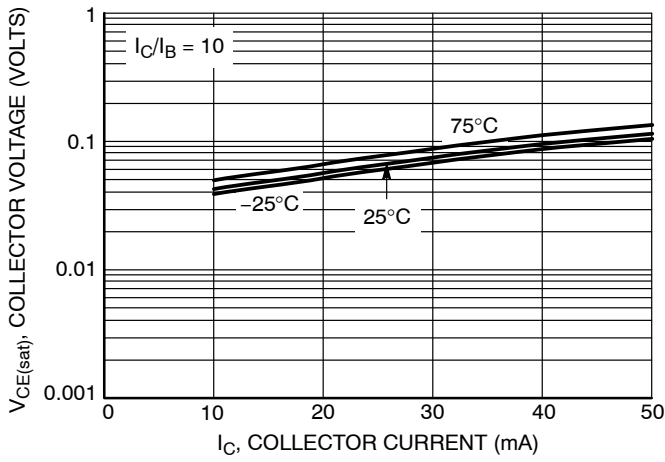

Figure 22.  $V_{CE(sat)}$  versus  $I_C$

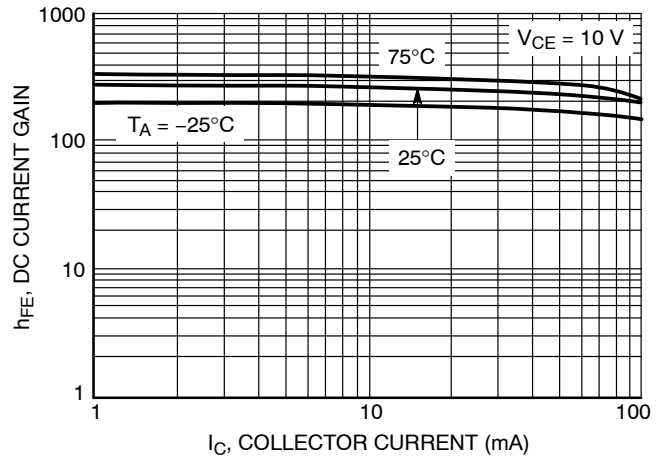

Figure 23. DC Current Gain

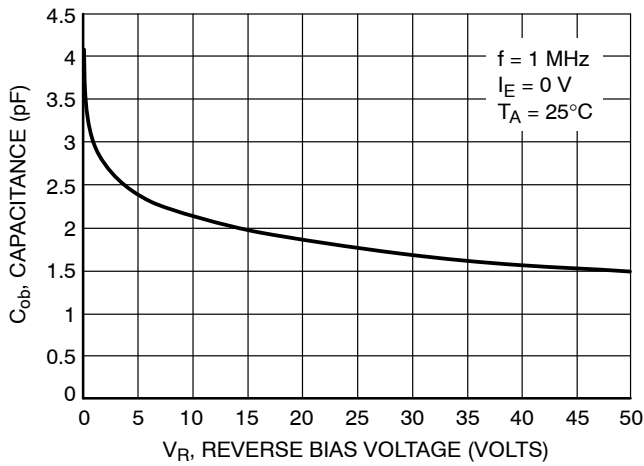

Figure 24. Output Capacitance

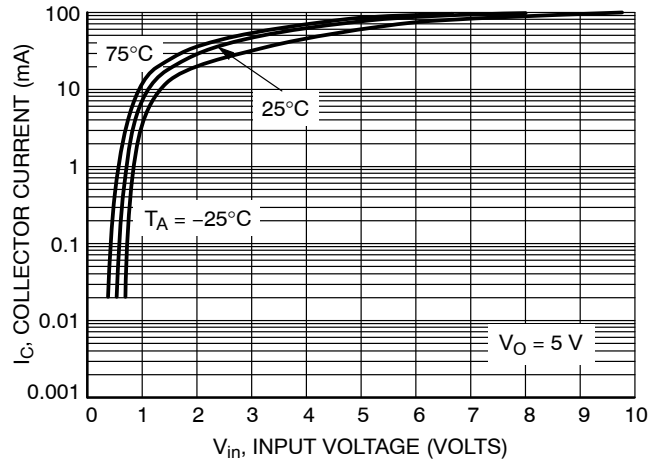

Figure 25. Output Current versus Input Voltage

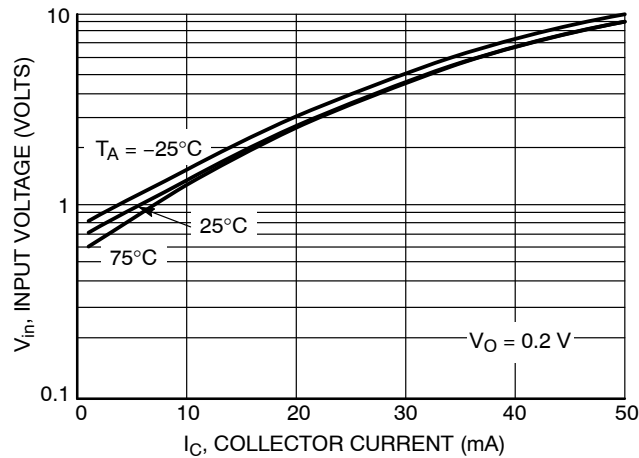

Figure 26. Input Voltage versus Output Current



TYPICAL ELECTRICAL CHARACTERISTICS — MMUN2216LT1G, SMMUN2216LT1G Series

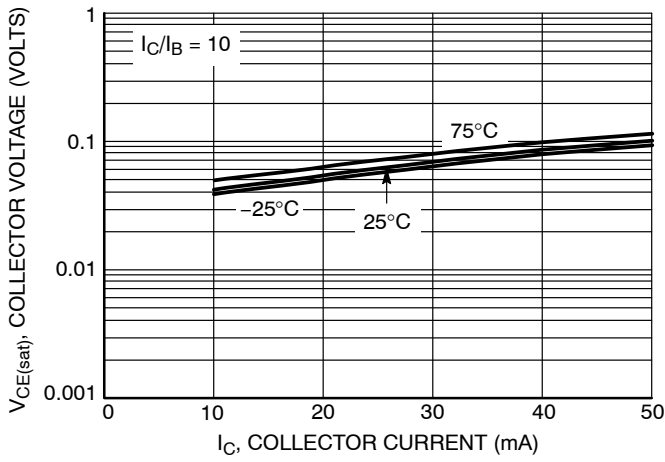

Figure 27.  $V_{CE(sat)}$  versus  $I_C$

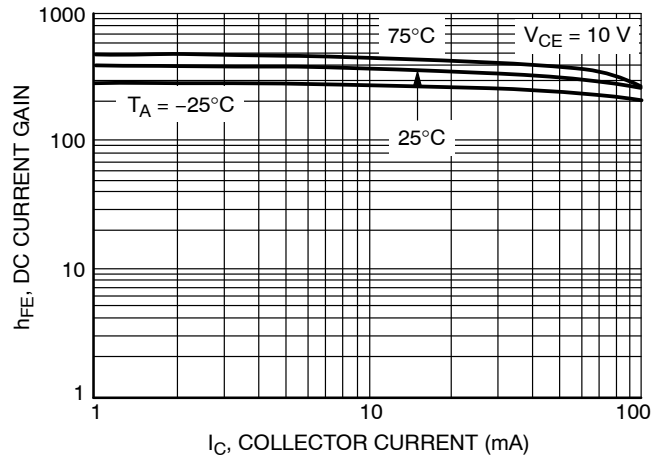

Figure 28. DC Current Gain

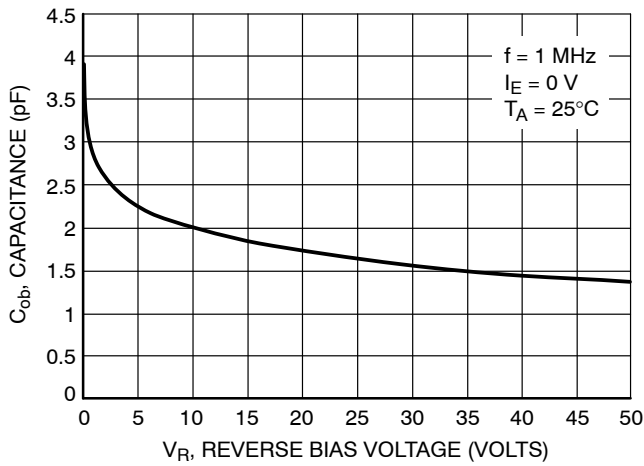

Figure 29. Output Capacitance

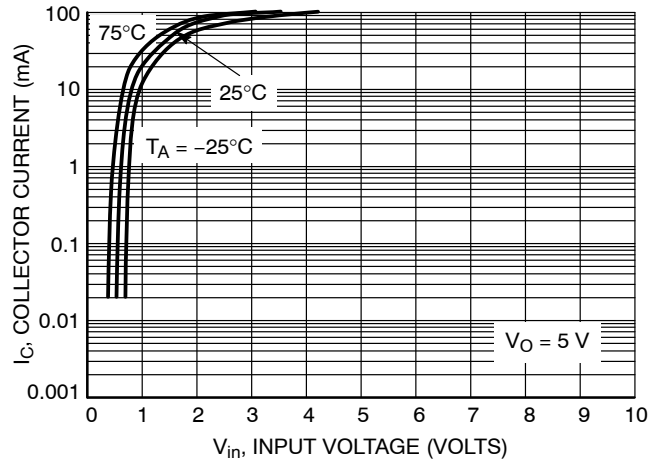

Figure 30. Output Current versus Input Voltage

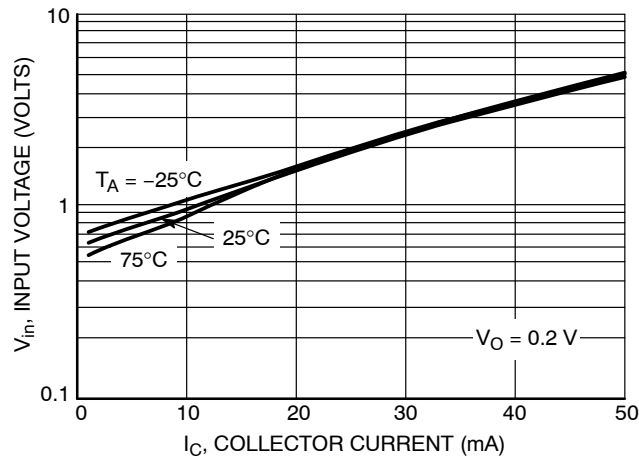

Figure 31. Input Voltage versus Output Current

TYPICAL ELECTRICAL CHARACTERISTICS — MMUN2230LT1G

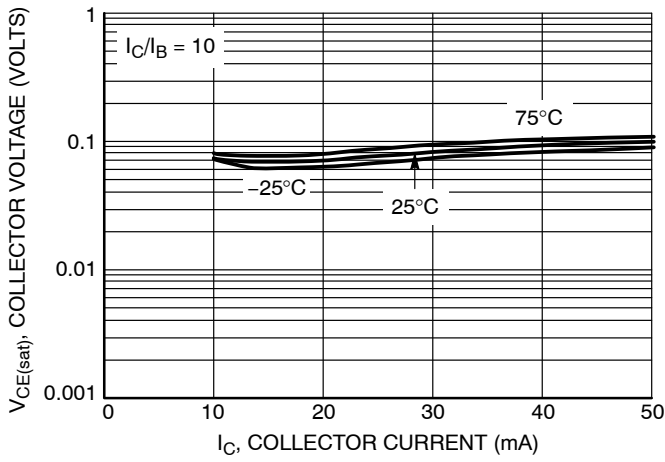

Figure 32.  $V_{CE(sat)}$  versus  $I_C$

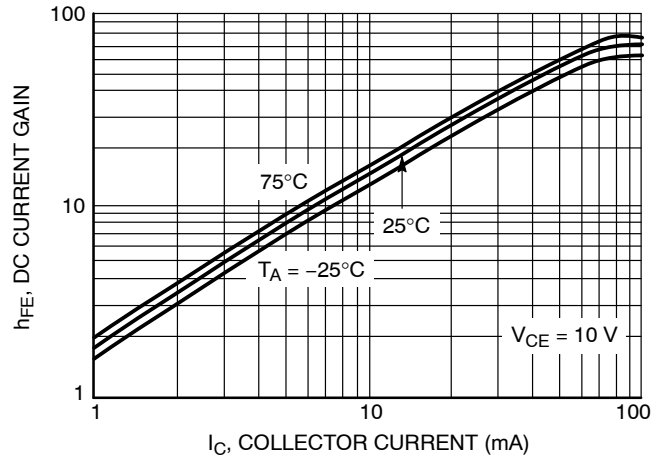

Figure 33. DC Current Gain

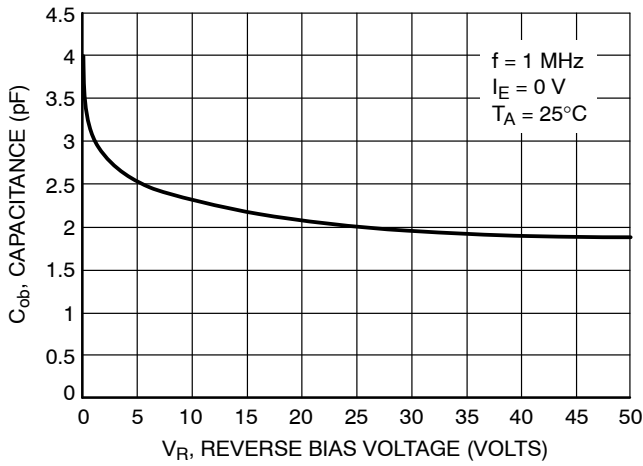

Figure 34. Output Capacitance

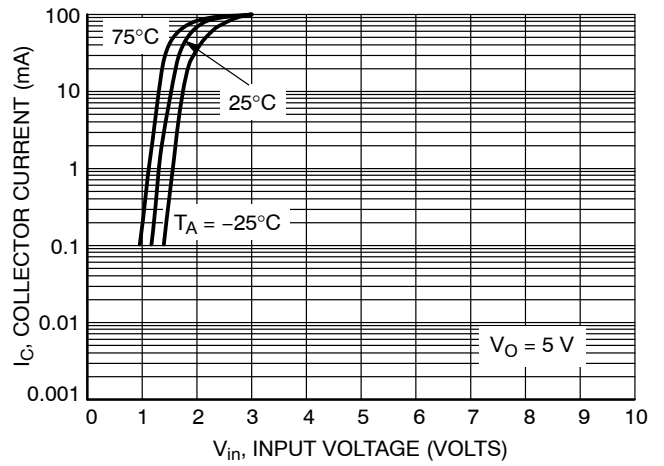

Figure 35. Output Current versus Input Voltage

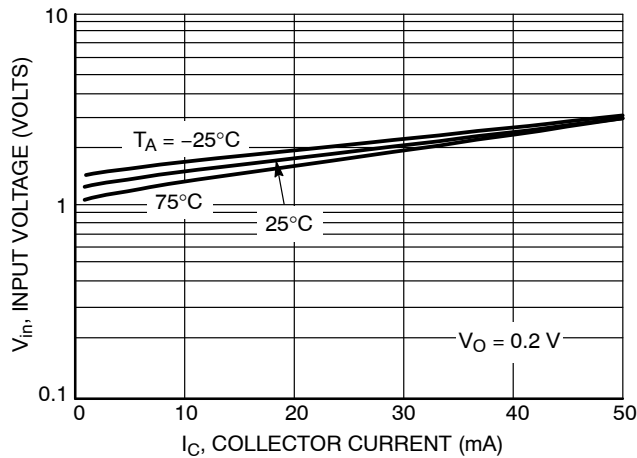

Figure 36. Input Voltage versus Output Current

TYPICAL ELECTRICAL CHARACTERISTICS — MMUN2231LT1G

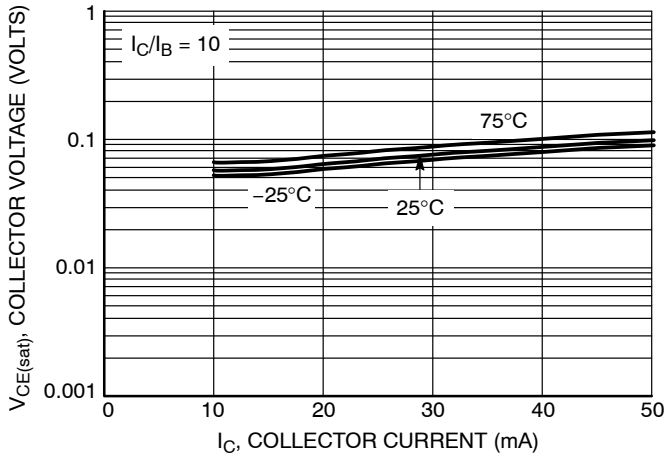

Figure 37.  $V_{CE(sat)}$  versus  $I_C$

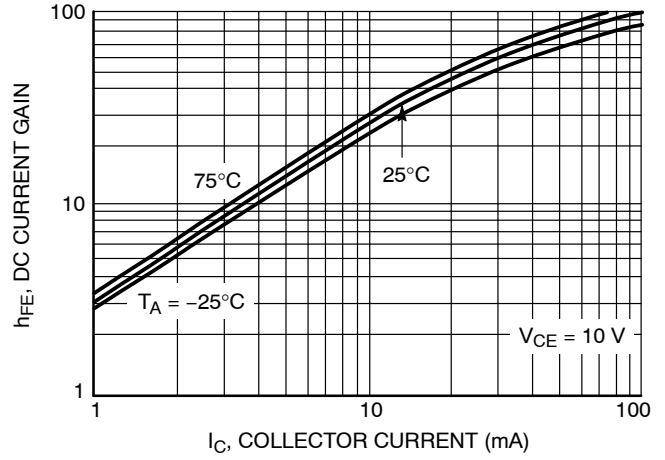

Figure 38. DC Current Gain

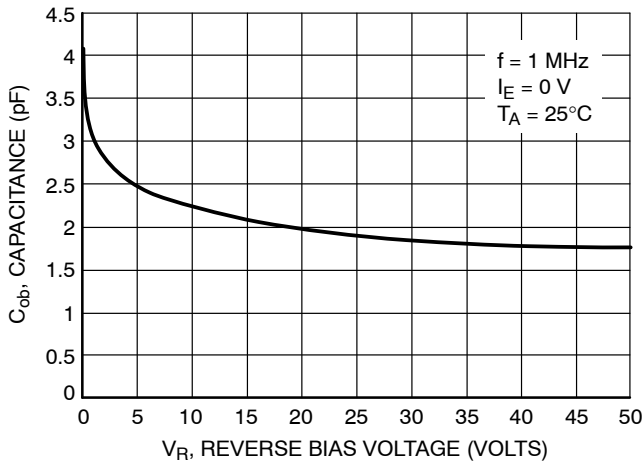

Figure 39. Output Capacitance

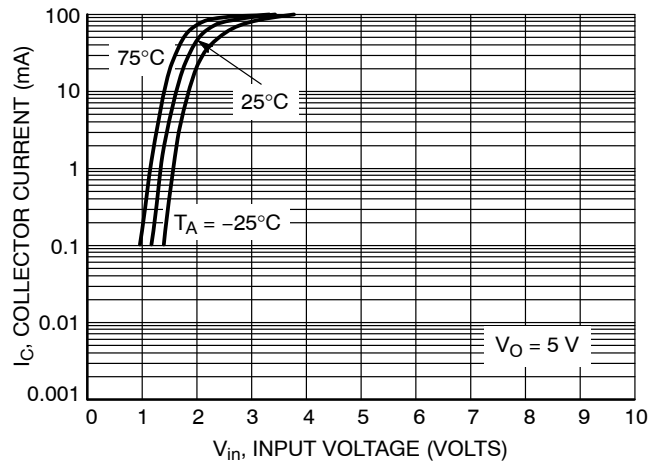

Figure 40. Output Current versus Input Voltage

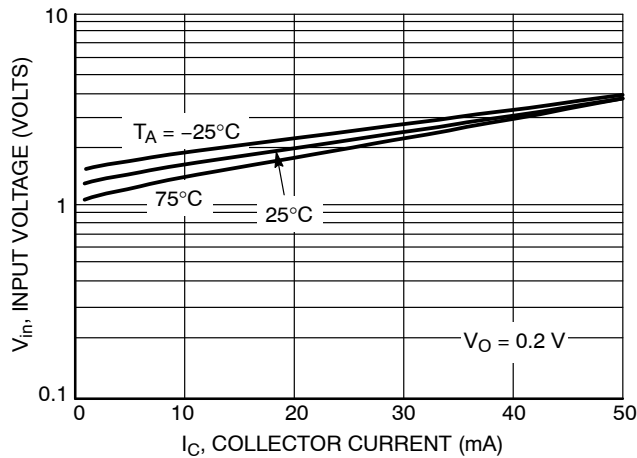

Figure 41. Input Voltage versus Output Current

TYPICAL ELECTRICAL CHARACTERISTICS – MMUN2232LT1G, NSVMMUN2232LT1G

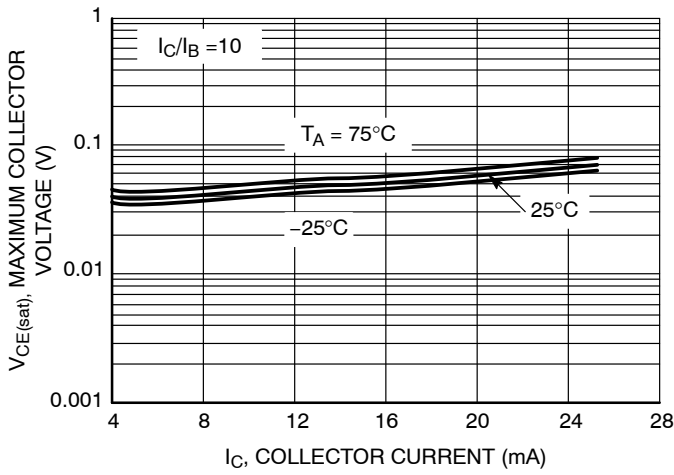

Figure 42.  $V_{CE(sat)}$  vs.  $I_C$

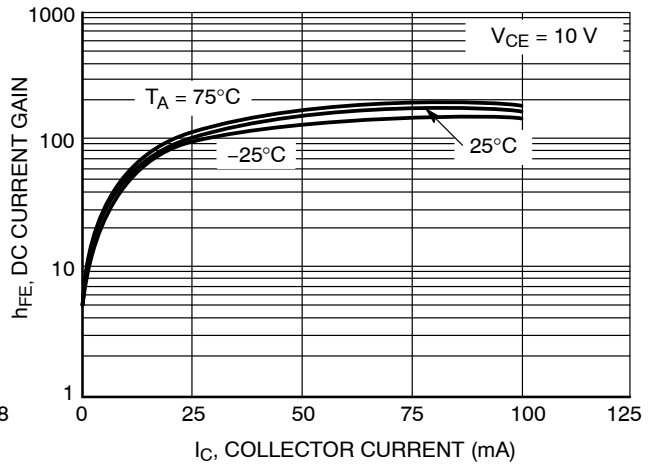

Figure 43. DC Current Gain

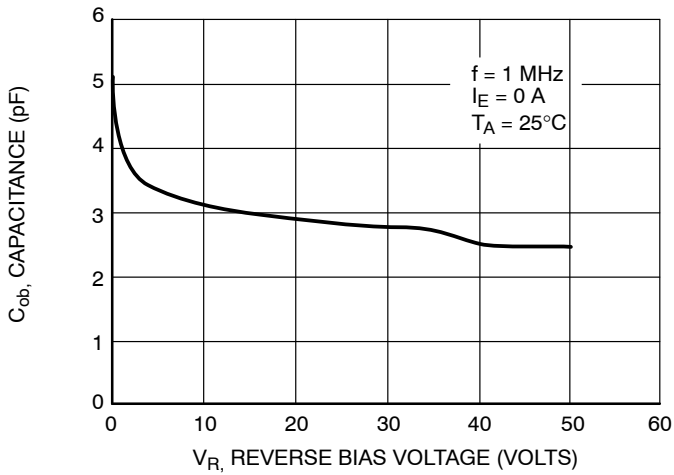

Figure 44. Output Capacitance

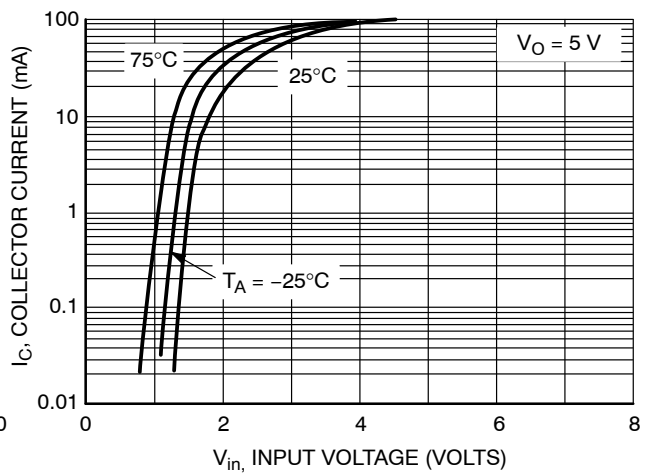

Figure 45. Output Current vs. Input Voltage

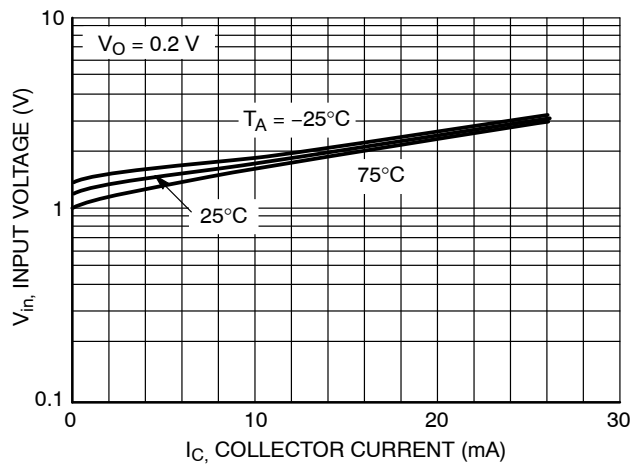

Figure 46. Output Voltage vs. Input Current

TYPICAL ELECTRICAL CHARACTERISTICS – MMUN2233LT1G, SMMUN2233LT1G

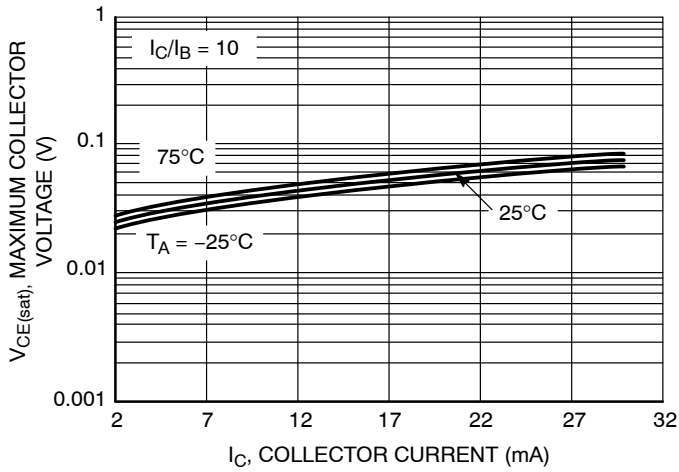

Figure 47.  $V_{CE(sat)}$  vs.  $I_C$

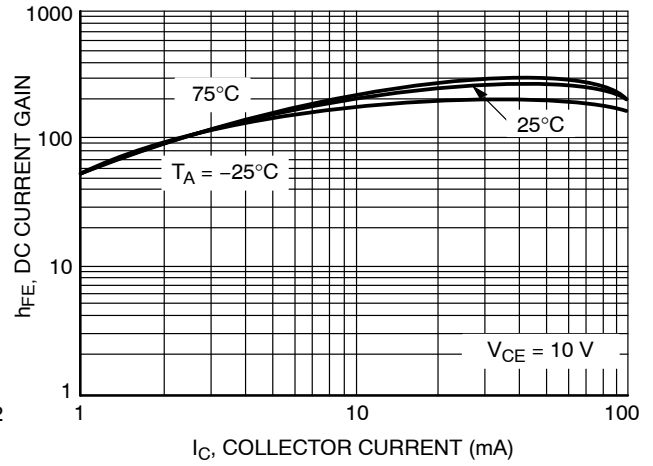

Figure 48. DC Current Gain

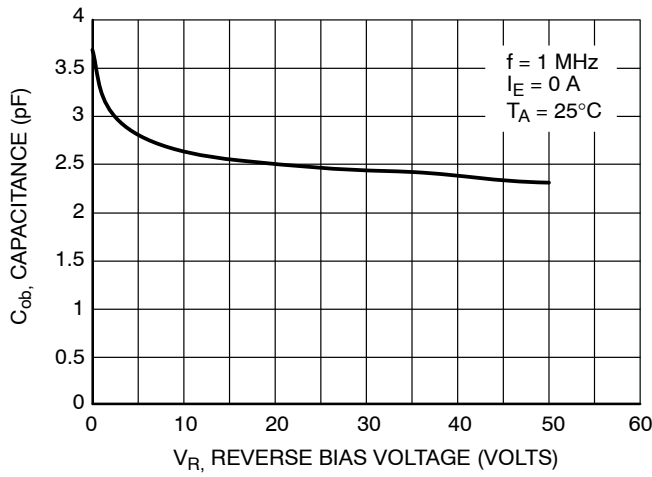

Figure 49. Output Capacitance

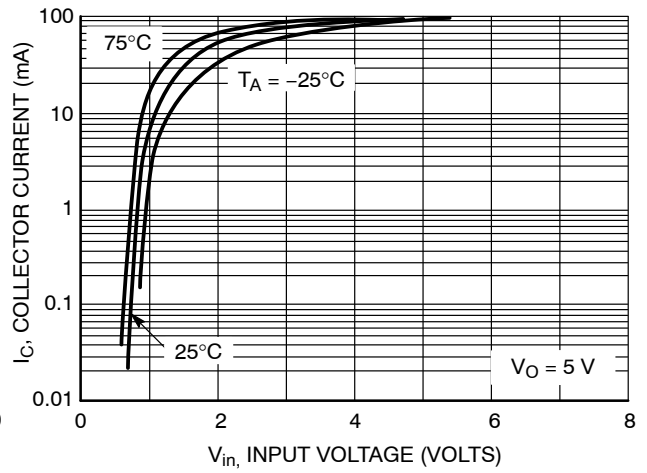

Figure 50. Output Current vs. Input Voltage

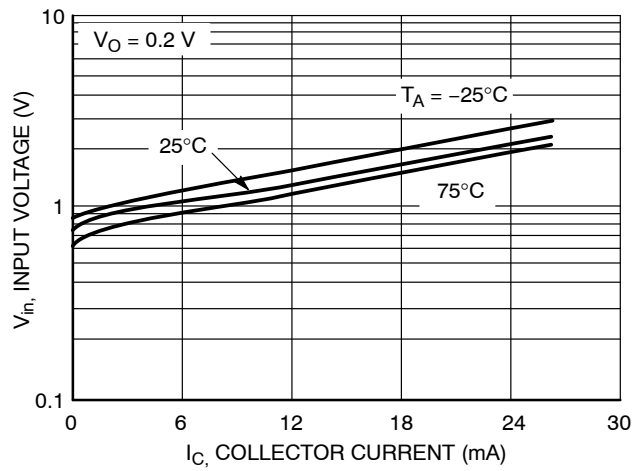

Figure 51. Input Voltage vs. Output Current

TYPICAL ELECTRICAL CHARACTERISTICS — MMUN2234LT1G, SMMUN2234LT1G

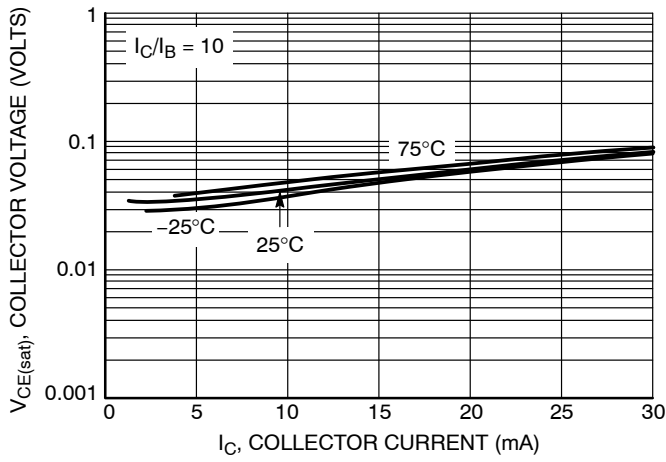

Figure 52.  $V_{CE(sat)}$  versus  $I_C$

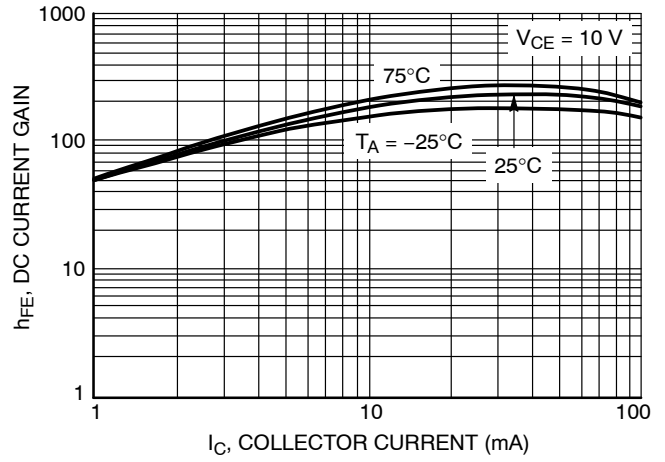

Figure 53. DC Current Gain

TYPICAL ELECTRICAL CHARACTERISTICS – MMUN2238LT1G

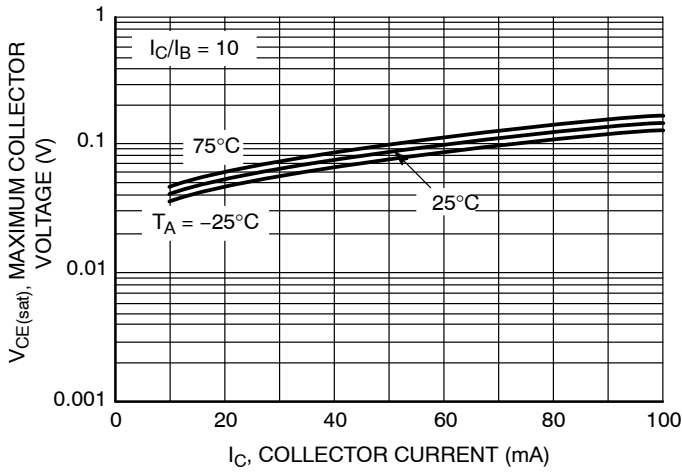

Figure 54.  $V_{CE(sat)}$  vs.  $I_C$

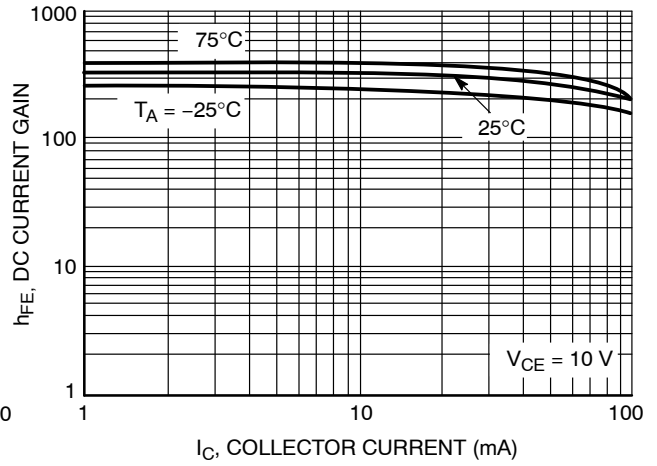

Figure 55. DC Current Gain

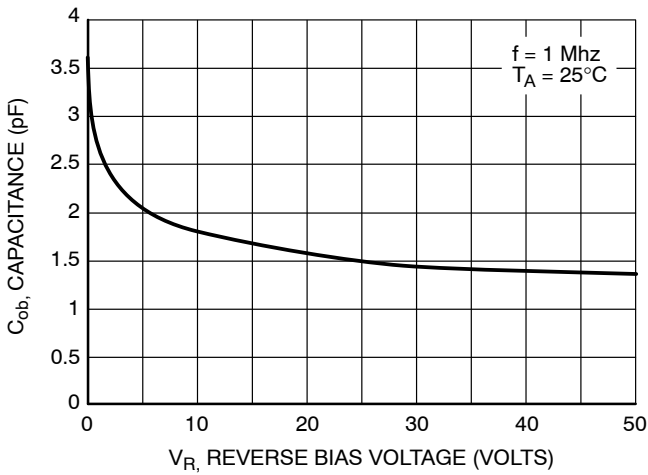

Figure 56. Output Capacitance

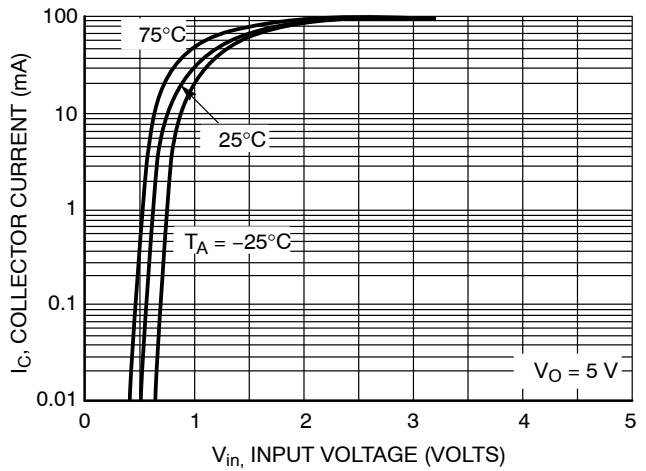

Figure 57. Output Current vs. Input Voltage

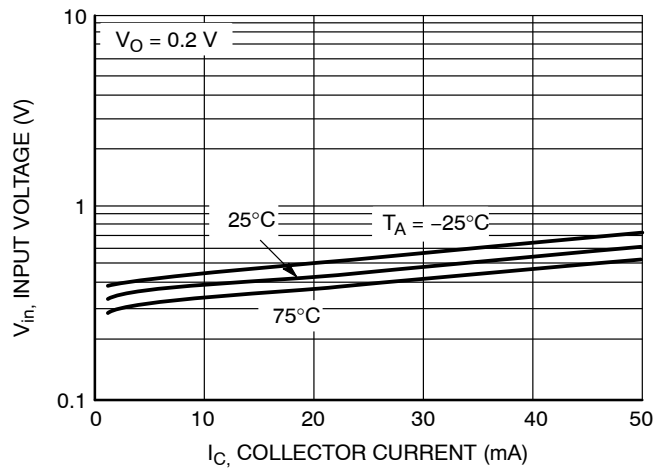

Figure 58. Input Voltage vs. Output Current

TYPICAL APPLICATIONS FOR NPN BRTs

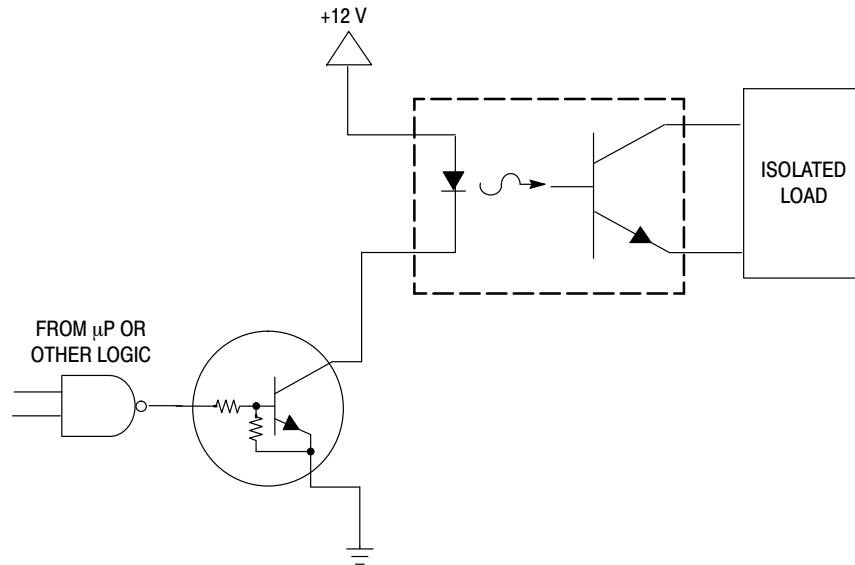

Figure 59. Level Shifter: Connects 12 or 24 Volt Circuits to Logic

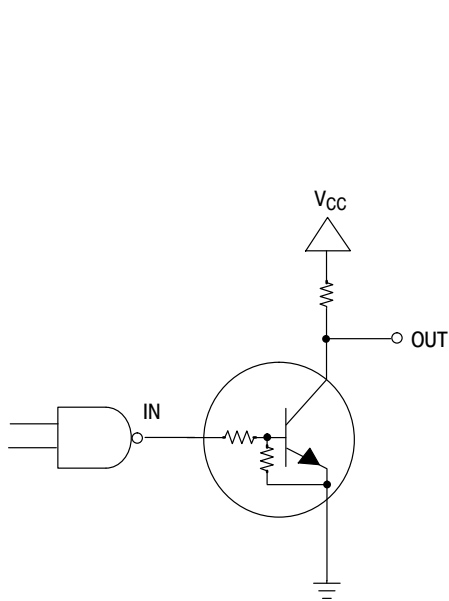

Figure 60. Open Collector Inverter: Inverts the Input Signal

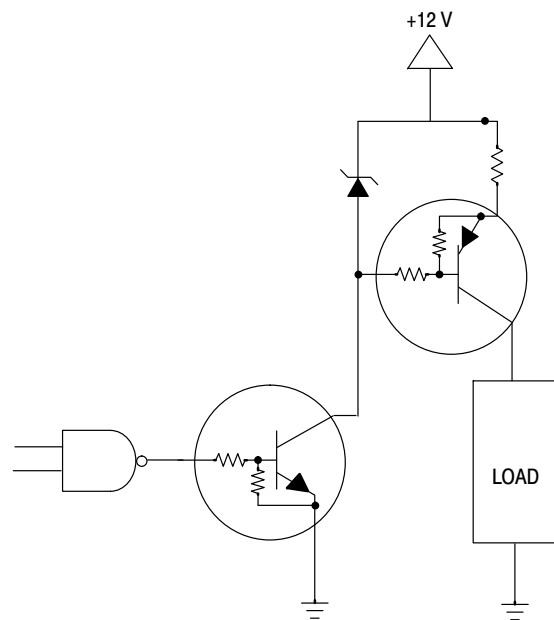

Figure 61. Inexpensive, Unregulated Current Source



# MMUN2211LT1G Series, SMMUN2211LT1G Series, NSVMMUN2232LT1G

## ORDERING INFORMATION

Device	Marking	R1(k)	R2(k)	Package	Shipping <sup>†</sup>
MMUN2211LT1G	A8A	10	10	SOT-23 (Pb-Free)	3000 / Tape & Reel
MMUN2211LT3G		10	10		10,000 / Tape & Reel
MMUN2212LT1G	A8B	22	22	SOT-23 (Pb-Free)	3000 / Tape & Reel
MMUN2213LT1G	A8C	47	47	SOT-23 (Pb-Free)	
MMUN2214LT1G	A8D	10	47	SOT-23 (Pb-Free)	
MMUN2215LT1G	A8E	10	∞	SOT-23 (Pb-Free)	
MMUN2216LT1G	A8F	4.7	∞	SOT-23 (Pb-Free)	
MMUN2230LT1G	A8G	1.0	1.0	SOT-23 (Pb-Free)	
MMUN2231LT1G	A8H	2.2	2.2	SOT-23 (Pb-Free)	
MMUN2232LT1G	A8J	4.7	4.7	SOT-23 (Pb-Free)	
MMUN2233LT1G	A8K	4.7	47	SOT-23 (Pb-Free)	
MMUN2234LT1G	A8L	22	47	SOT-23 (Pb-Free)	
MMUN2234LT3G		22	47	SOT-23 (Pb-Free)	
MMUN2238LT1G	A8R	2.2	∞	SOT-23 (Pb-Free)	
MMUN2241LT1G	A8U	100	∞	SOT-23 (Pb-Free)	
SMMUN2211LT1G	A8A	10	10	SOT-23 (Pb-Free)	3000 / Tape & Reel
SMMUN2211LT3G		10	10		10,000 / Tape & Reel
SMMUN2213LT1G	A8C	47	47	SOT-23 (Pb-Free)	3000 / Tape & Reel
SMMUN2213LT3G	A8C	47	47		10,000 / Tape & Reel
SMMUN2214LT1G	A8D	10	47	SOT-23 (Pb-Free)	3000 / Tape & Reel
SMMUN2215LT1G	A8E	10	∞	SOT-23 (Pb-Free)	3000 / Tape & Reel
SMMUN2216LT1G	A8F	4.7	∞	SOT-23 (Pb-Free)	3000 / Tape & Reel
SMMUN2216LT3G		4.7	∞		10,000 / Tape & Reel
SMMUN2233LT1G	A8K	4.7	4.7	SOT-23 (Pb-Free)	3000 / Tape & Reel
SMMUN2234LT1G	A8L	22	47	SOT-23 (Pb-Free)	3000 / Tape & Reel
NSVMMUN2232LT1G	A8J	4.7	4.7	SOT-23 (Pb-Free)	3000 / Tape & Reel

<sup>†</sup>For information on tape and reel specifications, including part orientation and tape sizes, please refer to our Tape and Reel Packaging Specifications Brochure, BRD8011/D.

# MMUN2211LT1G Series, SMMUN2211LT1G Series, NSVMMUN2232LT1G

## PACKAGE DIMENSIONS

SOT-23 (TO-236)  
CASE 318-08  
ISSUE AP

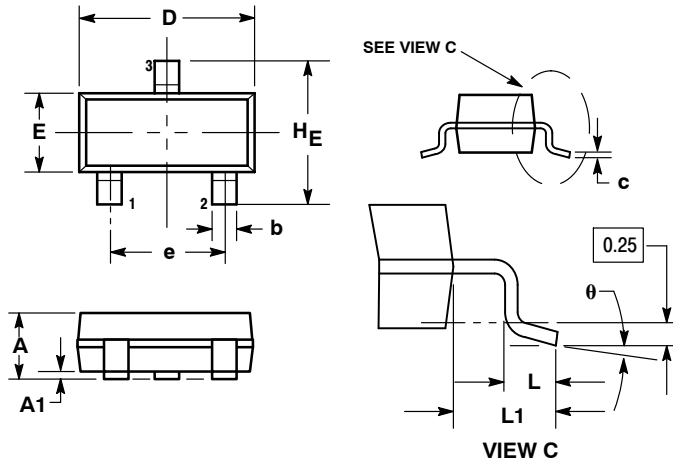

NOTES:

1. DIMENSIONING AND TOLERANCING PER ANSI Y14.5M, 1982.
2. CONTROLLING DIMENSION: INCH.
3. MAXIMUM LEAD THICKNESS INCLUDES LEAD FINISH THICKNESS. MINIMUM LEAD THICKNESS IS THE MINIMUM THICKNESS OF BASE MATERIAL.
4. DIMENSIONS D AND E DO NOT INCLUDE MOLD FLASH, PROTRUSIONS, OR GATE BURRS.

DIM	MILLIMETERS			INCHES		
	MIN	NOM	MAX	MIN	NOM	MAX
A	0.89	1.00	1.11	0.035	0.040	0.044
A1	0.01	0.06	0.10	0.001	0.002	0.004
b	0.37	0.44	0.50	0.015	0.018	0.020
c	0.09	0.13	0.18	0.003	0.005	0.007
D	2.80	2.90	3.04	0.110	0.114	0.120
E	1.20	1.30	1.40	0.047	0.051	0.055
e	1.78	1.90	2.04	0.070	0.075	0.081
L	0.10	0.20	0.30	0.004	0.008	0.012
L1	0.35	0.54	0.69	0.014	0.021	0.029
HE	2.10	2.40	2.64	0.083	0.094	0.104
θ	0°	---	10°	0°	---	10°

STYLE 6:

- PIN 1. BASE
- EMITTER
- COLLECTOR

### SOLDERING FOOTPRINT\*

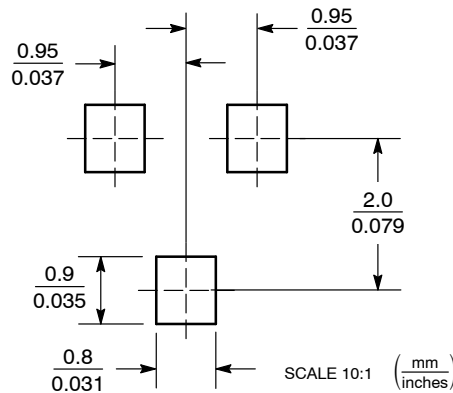

\*For additional information on our Pb-Free strategy and soldering details, please download the ON Semiconductor Soldering and Mounting Techniques Reference Manual, SOLDERRM/D.

ON Semiconductor and are registered trademarks of Semiconductor Components Industries, LLC (SCILLC). SCILLC reserves the right to make changes without further notice to any products herein. SCILLC makes no warranty, representation or guarantee regarding the suitability of its products for any particular purpose, nor does SCILLC assume any liability arising out of the application or use of any product or circuit, and specifically disclaims any and all liability, including without limitation special, consequential or incidental damages. "Typical" parameters which may be provided in SCILLC data sheets and/or specifications can and do vary in different applications and actual performance may vary over time. All operating parameters, including "Typicals" must be validated for each customer application by customer's technical experts. SCILLC does not convey any license under its patent rights nor the rights of others. SCILLC products are not designed, intended, or authorized for use as components in systems intended for surgical implant into the body, or other applications intended to support or sustain life, or for any other application in which the failure of the SCILLC product could create a situation where personal injury or death may occur. Should Buyer purchase or use SCILLC products for any such unintended or unauthorized application, Buyer shall indemnify and hold SCILLC and its officers, employees, subsidiaries, affiliates, and distributors harmless against all claims, costs, damages, and expenses, and reasonable attorney fees arising out of, directly or indirectly, any claim of personal injury or death associated with such unintended or unauthorized use, even if such claim alleges that SCILLC was negligent regarding the design or manufacture of the part. SCILLC is an Equal Opportunity/Affirmative Action Employer. This literature is subject to all applicable copyright laws and is not for resale in any manner.

### PUBLICATION ORDERING INFORMATION

**LITERATURE FULFILLMENT:**  
Literature Distribution Center for ON Semiconductor  
P.O. Box 5163, Denver, Colorado 80217 USA  
Phone: 303-675-2175 or 800-344-3860 Toll Free USA/Canada  
Fax: 303-675-2176 or 800-344-3867 Toll Free USA/Canada  
Email: orderlit@onsemi.com

**N. American Technical Support:** 800-282-9855 Toll Free  
USA/Canada  
**Europe, Middle East and Africa Technical Support:**  
Phone: 421 33 790 2910  
**Japan Customer Focus Center**  
Phone: 81-3-5817-1050

**ON Semiconductor Website:** [www.onsemi.com](http://www.onsemi.com)  
**Order Literature:** <http://www.onsemi.com/orderlit>  
For additional information, please contact your local Sales Representative