

PRELIMINARY

# IRG4PSH71KD

INSULATED GATE BIPOLAR TRANSISTOR WITH  
ULTRAFAST SOFT RECOVERY DIODE

Short Circuit Rated  
UltraFast IGBT

## Features

- Hole-less clip/pressure mount package compatible with TO-247 and TO-264, with reinforced pins
- High short circuit rating IGBTs, optimized for motorcontrol
- Minimum switching losses combined with low conduction losses
- Tightest parameter distribution
- IGBT co-packaged with ultrafast soft recovery antiparallel diode
- Creepage distance increased to 5.35mm

## Benefits

- Highest current rating copack IGBT
- Maximum power density, twice the power handling of the TO-247, less space than TO-264
- HEXFRED™ diode optimized for operation with IGBT, to minimize EMI, noise and switching losses

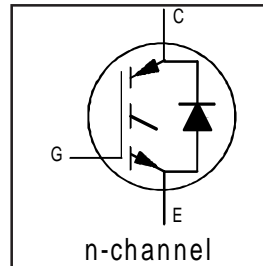

$V_{CES} = 1200V$
$V_{CE(on)} \text{ typ.} = 2.97V$
@ $V_{GE} = 15V, I_C = 42A$

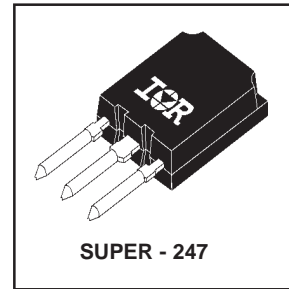

## Absolute Maximum Ratings

	Parameter	Max.	Units
$V_{CES}$	Collector-to-Emitter Voltage	1200	V
$I_C @ T_C = 25^\circ C$	Continuous Collector Current	78	A
$I_C @ T_C = 100^\circ C$	Continuous Collector Current	42	
$I_{CM}$	Pulsed Collector Current ①	156	
$I_{LM}$	Clamped Inductive Load Current ②	156	
$I_F @ T_C = 100^\circ C$	Diode Continuous Forward Current	42	
$I_{FM}$	Diode Maximum Forward Current	156	
$t_{sc}$	Short Circuit Withstand Time	10	$\mu s$
$V_{GE}$	Gate-to-Emitter Voltage	$\pm 20$	V
$P_D @ T_C = 25^\circ C$	Maximum Power Dissipation	350	W
$P_D @ T_C = 100^\circ C$	Maximum Power Dissipation	140	
$T_J$	Operating Junction and	-55 to +150	$^\circ C$
$T_{STG}$	Storage Temperature Range		
	Soldering Temperature, for 10 sec.	300 (0.063 in. (1.6mm) from case)	

## Thermal Resistance\ Mechanical

	Parameter	Min.	Typ.	Max.	Units
$R_{\theta JC}$	Junction-to-Case - IGBT	—	—	0.36	$^\circ C/W$
$R_{\theta JC}$	Junction-to-Case - Diode	—	—	0.69	
$R_{\theta CS}$	Case-to-Sink, flat, greased surface	—	0.24	—	
$R_{\theta JA}$	Junction-to-Ambient, typical socket mount	—	—	38	
	Recommended Clip Force	20.0(2.0)	—	—	N (kgf)
	Weight	—	6 (0.21)	—	g (oz)

**Electrical Characteristics @ T<sub>J</sub> = 25°C (unless otherwise specified)**

	Parameter	Min.	Typ.	Max.	Units	Conditions
V <sub>(BR)CES</sub>	Collector-to-Emitter Breakdown Voltage <sup>③</sup>	1200	—	—	V	V <sub>GE</sub> = 0V, I <sub>C</sub> = 250μA
ΔV <sub>(BR)CES/ΔT<sub>J</sub></sub>	Temperature Coeff. of Breakdown Voltage	—	1.1	—	V/°C	V <sub>GE</sub> = 0V, I <sub>C</sub> = 10mA
V <sub>CE(on)</sub>	Collector-to-Emitter Saturation Voltage	—	2.97	3.9	V	I <sub>C</sub> = 42A V <sub>GE</sub> = 15V
		—	3.44	—		I <sub>C</sub> = 78A See Fig. 2, 5
		—	2.60	—		I <sub>C</sub> = 42A, T <sub>J</sub> = 150°C
V <sub>GE(th)</sub>	Gate Threshold Voltage	3.0	—	6.0		V <sub>CE</sub> = V <sub>GE</sub> , I <sub>C</sub> = 250μA
ΔV <sub>GE(th)/ΔT<sub>J</sub></sub>	Temperature Coeff. of Threshold Voltage	—	-12	—	mV/°C	V <sub>CE</sub> = V <sub>GE</sub> , I <sub>C</sub> = 1.5mA
g <sub>fe</sub>	Forward Transconductance <sup>④</sup>	25	38	—	S	V <sub>CE</sub> = 50V, I <sub>C</sub> = 42A
I <sub>CES</sub>	Zero Gate Voltage Collector Current	—	—	500	μA	V <sub>GE</sub> = 0V, V <sub>CE</sub> = 1200V
		—	—	10	mA	V <sub>GE</sub> = 0V, V <sub>CE</sub> = 1200V, T <sub>J</sub> = 150°C
V <sub>FM</sub>	Diode Forward Voltage Drop	—	2.5	3.7	V	I <sub>C</sub> = 42A See Fig. 13
		—	2.4	—		I <sub>C</sub> = 42A, T <sub>J</sub> = 150°C
I <sub>GES</sub>	Gate-to-Emitter Leakage Current	—	—	±100	nA	V <sub>GE</sub> = ±20V

**Switching Characteristics @ T<sub>J</sub> = 25°C (unless otherwise specified)**

	Parameter	Min.	Typ.	Max.	Units	Conditions
Q <sub>g</sub>	Total Gate Charge (turn-on)	—	410	610	nC	I <sub>C</sub> = 42A V <sub>CC</sub> = 400V See Fig.8 V <sub>GE</sub> = 15V
Q <sub>ge</sub>	Gate - Emitter Charge (turn-on)	—	47	70		
Q <sub>gc</sub>	Gate - Collector Charge (turn-on)	—	145	220		
t <sub>d(on)</sub>	Turn-On Delay Time	—	67	—	ns	T <sub>J</sub> = 25°C I <sub>C</sub> = 42A, V <sub>CC</sub> = 800V V <sub>GE</sub> = 15V, R <sub>G</sub> = 5.0Ω
t <sub>r</sub>	Rise Time	—	84	—		
t <sub>d(off)</sub>	Turn-Off Delay Time	—	230	350		
t <sub>f</sub>	Fall Time	—	130	190		
E <sub>on</sub>	Turn-On Switching Loss	—	5.68	—	mJ	Energy losses include "tail" and diode reverse recovery See Fig. 9,10,18
E <sub>off</sub>	Turn-Off Switching Loss	—	3.23	—		
E <sub>ts</sub>	Total Switching Loss	—	8.90	11.6		
t <sub>sc</sub>	Short Circuit Withstand Time	10	—	—	μs	V <sub>CC</sub> = 720V, T <sub>J</sub> = 125°C V <sub>GE</sub> = 15V, R <sub>G</sub> = 5.0Ω
t <sub>d(on)</sub>	Turn-On Delay Time	—	65	—	ns	T <sub>J</sub> = 150°C, See Fig. 11,18 I <sub>C</sub> = 42A, V <sub>CC</sub> = 800V V <sub>GE</sub> = 15V, R <sub>G</sub> = 5.0Ω
t <sub>r</sub>	Rise Time	—	87	—		
t <sub>d(off)</sub>	Turn-Off Delay Time	—	370	—		
t <sub>f</sub>	Fall Time	—	290	—		
E <sub>ts</sub>	Total Switching Loss	—	13.7	—	mJ	Energy losses include "tail" and diode reverse recovery
L <sub>E</sub>	Internal Emitter Inductance	—	13	—	nH	Measured 5mm from package
C <sub>ies</sub>	Input Capacitance	—	5770	—	pF	V <sub>GE</sub> = 0V V <sub>CC</sub> = 30V See Fig. 7 f = 1.0MHz
C <sub>oes</sub>	Output Capacitance	—	400	—		
C <sub>res</sub>	Reverse Transfer Capacitance	—	100	—		
t <sub>rr</sub>	Diode Reverse Recovery Time	—	107	160	ns	T <sub>J</sub> = 25°C See Fig. 14
		—	160	240		T <sub>J</sub> = 125°C
I <sub>rr</sub>	Diode Peak Reverse Recovery Current	—	10	15	A	T <sub>J</sub> = 25°C See Fig. 15
		—	16	24		T <sub>J</sub> = 125°C
Q <sub>rr</sub>	Diode Reverse Recovery Charge	—	680	1020	nC	T <sub>J</sub> = 25°C See Fig. 16
		—	1400	2100		T <sub>J</sub> = 125°C
di <sub>(rec)M/dt</sub>	Diode Peak Rate of Fall of Recovery During t <sub>b</sub>	—	250	—	A/μs	T <sub>J</sub> = 25°C See Fig. 17
		—	320	—		T <sub>J</sub> = 125°C

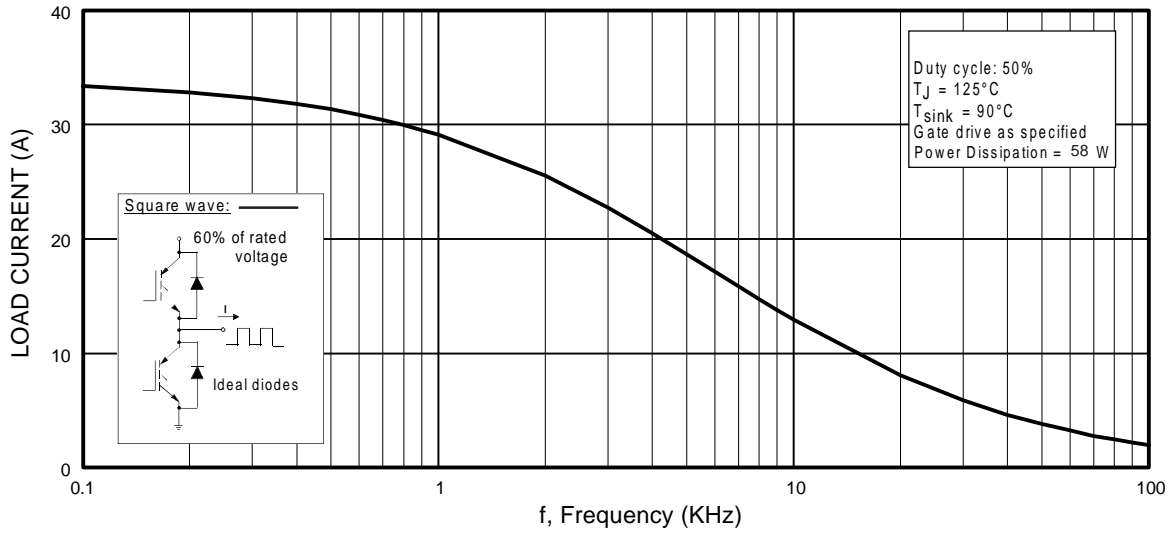

**Fig. 1** - Typical Load Current vs. Frequency  
 (Load Current =  $I_{\text{RMS}}$  of fundamental)

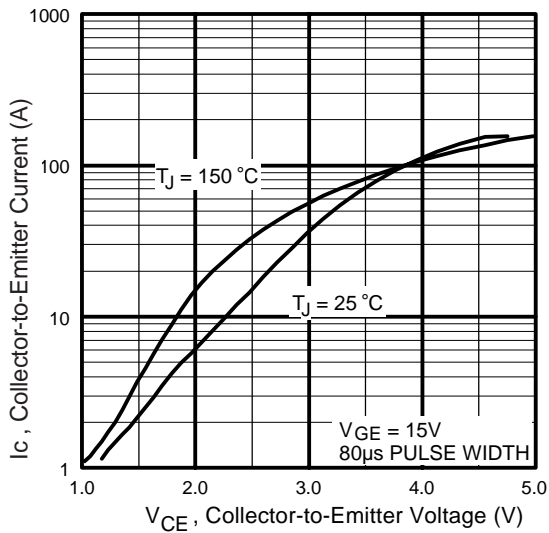

**Fig. 2** - Typical Output Characteristics

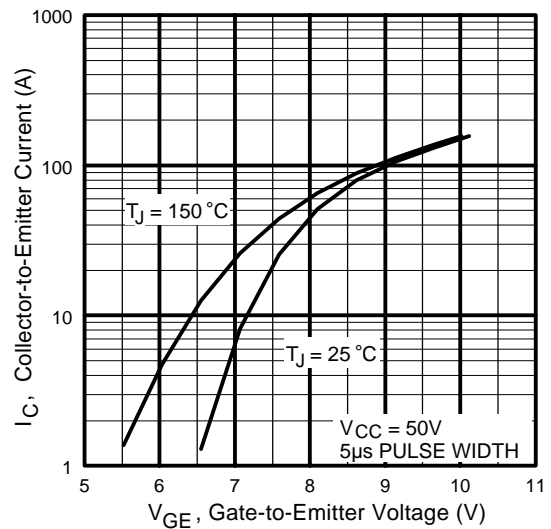

**Fig. 3** - Typical Transfer Characteristics

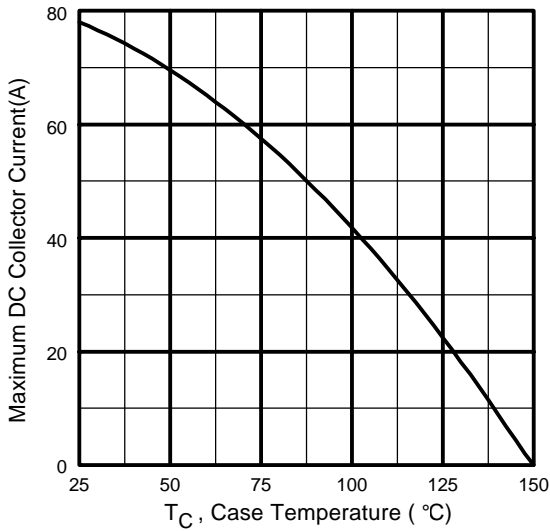

Fig. 4 - Maximum Collector Current vs. Case Temperature

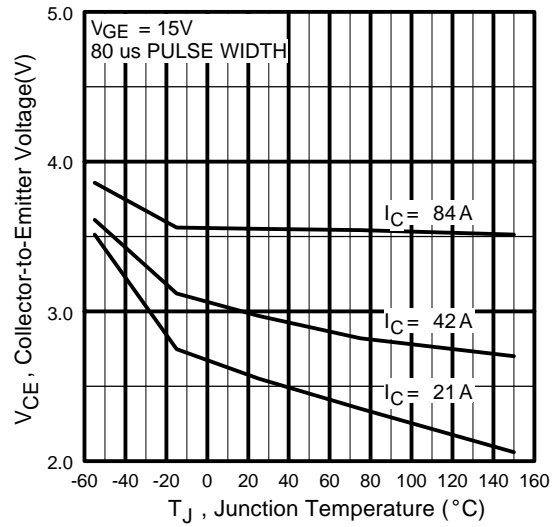

Fig. 5 - Typical Collector-to-Emitter Voltage vs. Junction Temperature

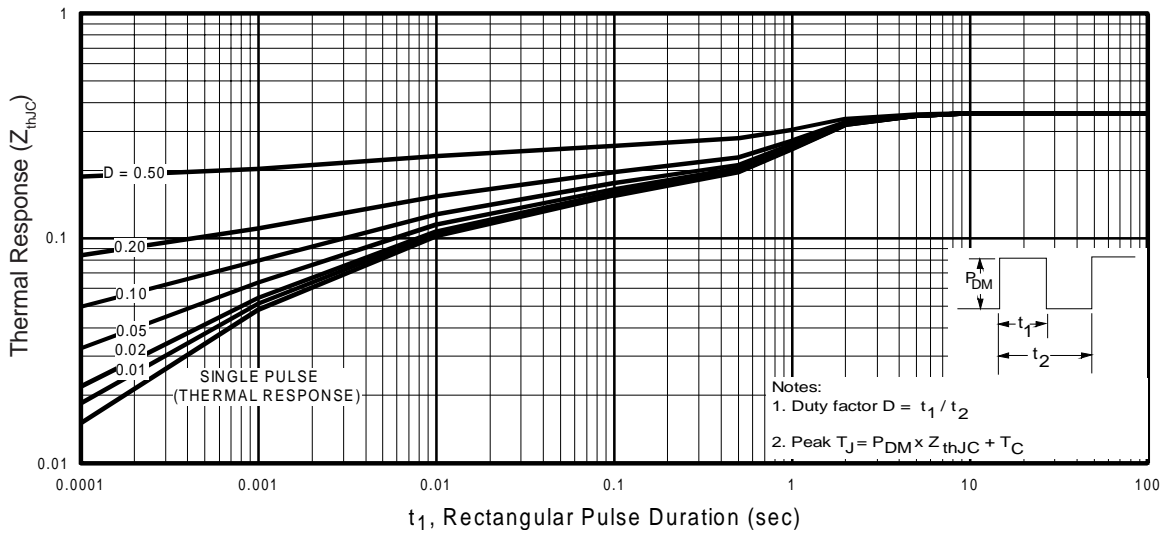

Fig. 6 - Maximum Effective Transient Thermal Impedance, Junction-to-Case

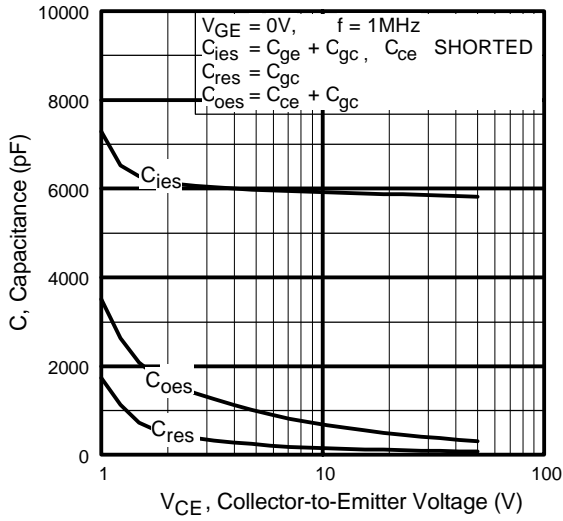

Fig. 7 - Typical Capacitance vs. Collector-to-Emitter Voltage

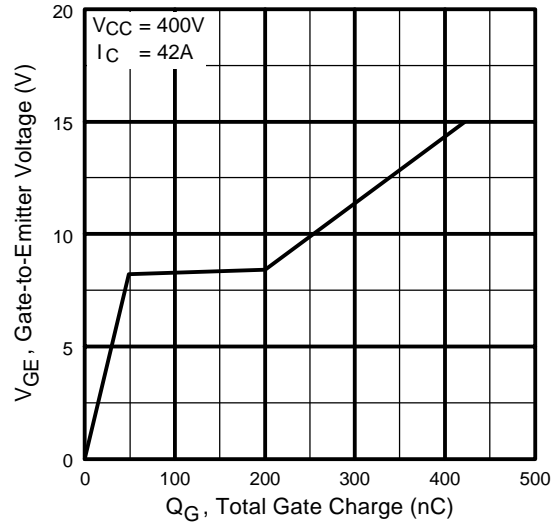

Fig. 8 - Typical Gate Charge vs. Gate-to-Emitter Voltage

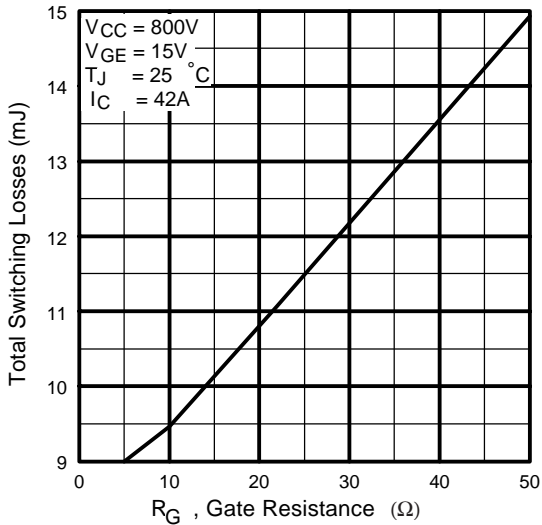

Fig. 9 - Typical Switching Losses vs. Gate Resistance

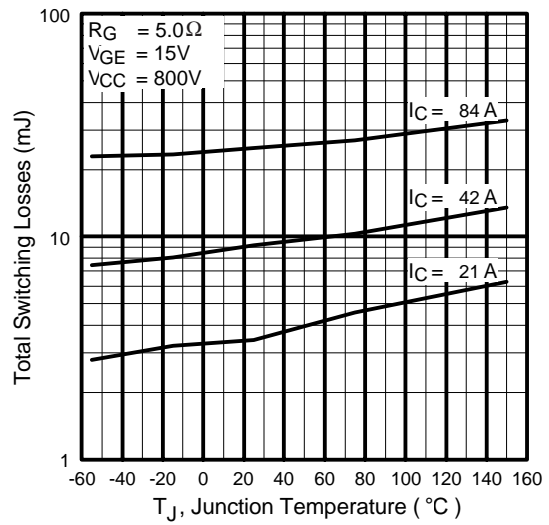
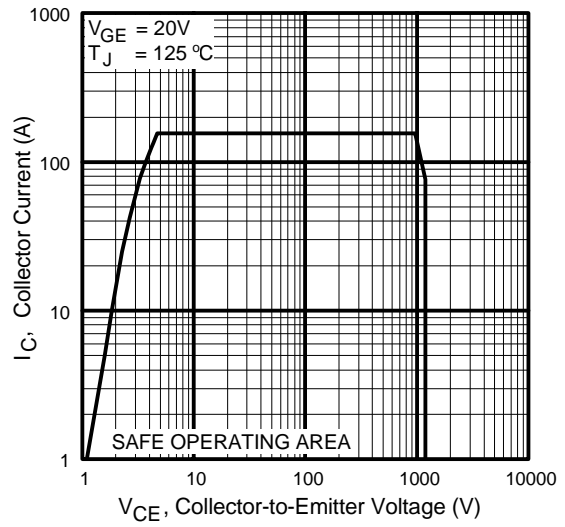
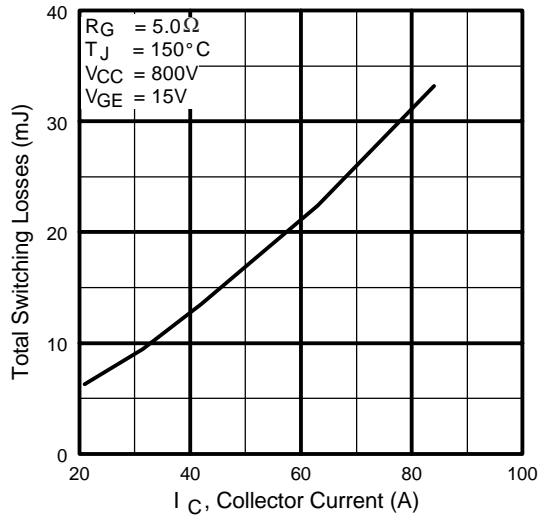
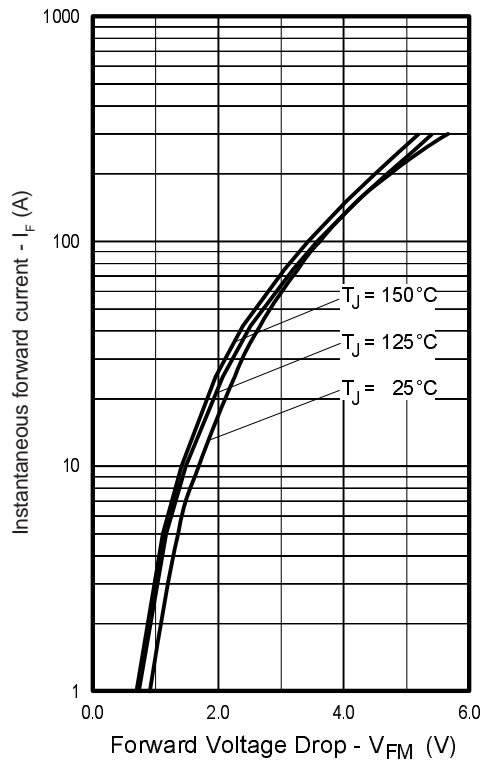

Fig. 10 - Typical Switching Losses vs. Junction Temperature

# IRG4PSH71KD



## Collector-to-Emitter Current



**Fig. 13** - Maximum Forward Voltage Drop vs. Instantaneous Forward Current

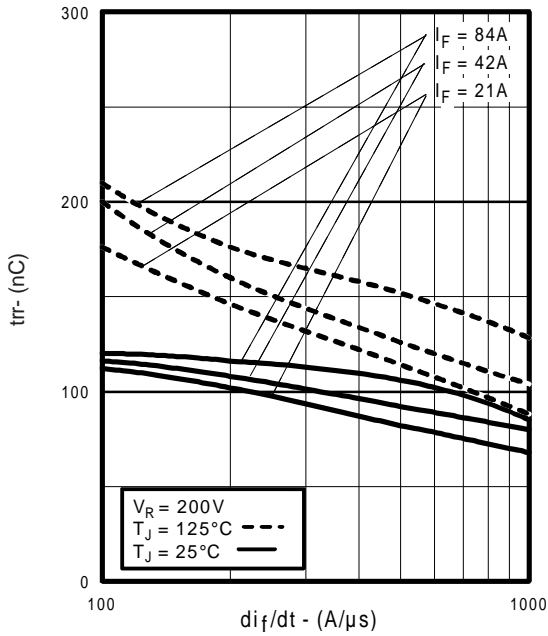

Fig. 14 - Typical Reverse Recovery vs.  $di_f/dt$

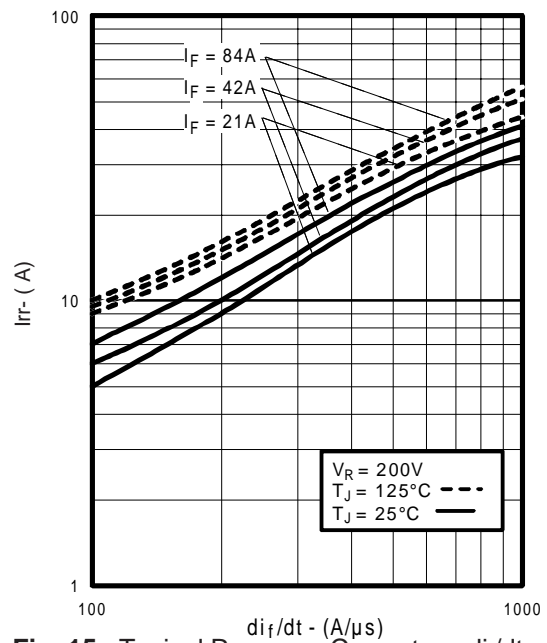

Fig. 15 - Typical Recovery Current vs.  $di_f/dt$

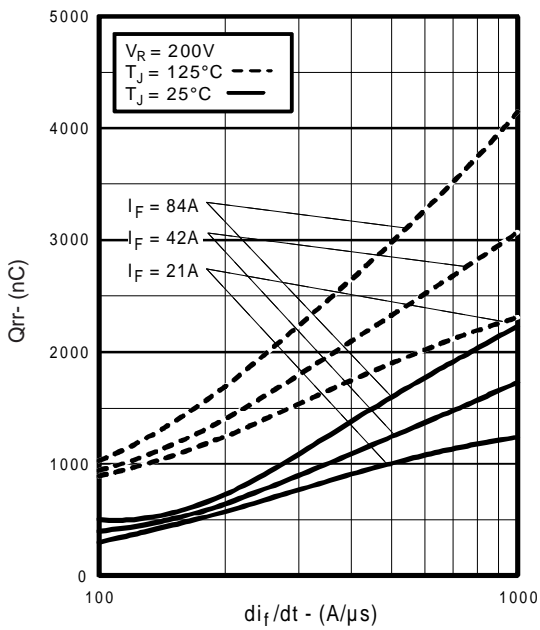

Fig. 16 - Typical Stored Charge vs.  $di_f/dt$   
www.irf.com

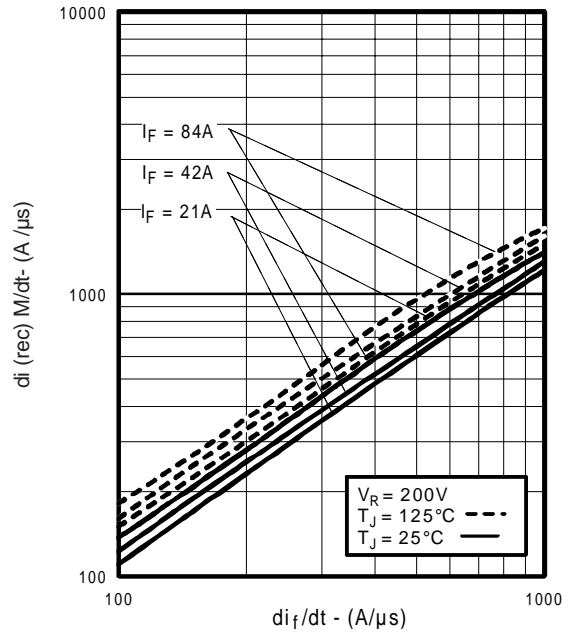
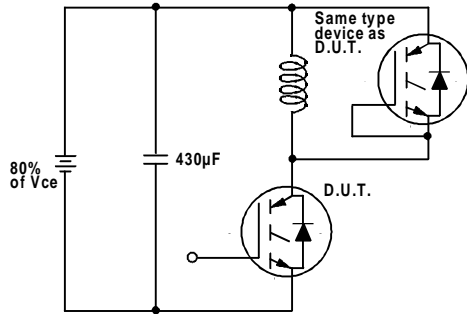
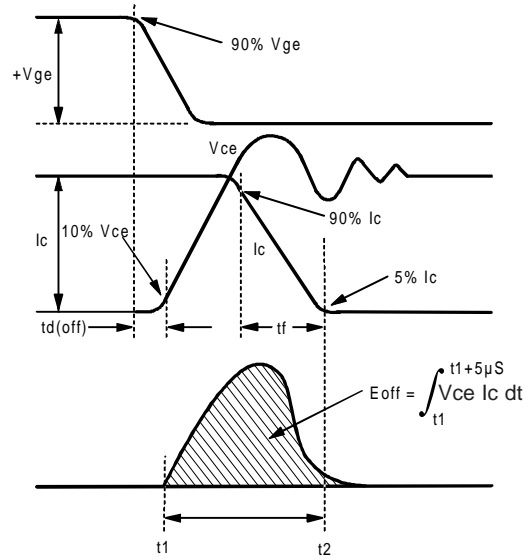

Fig. 17 - Typical  $di_{(rec)M}/dt$  vs.  $di_f/dt$



**Fig. 18a** - Test Circuit for Measurement of  $I_{LM}$ ,  $E_{on}$ ,  $E_{off}(\text{diode})$ ,  $t_{rr}$ ,  $Q_{rr}$ ,  $I_{rr}$ ,  $t_{d(on)}$ ,  $t_r$ ,  $t_{d(off)}$ ,  $t_f$



**Fig. 18b** - Test Waveforms for Circuit of Fig. 18a, Defining  $E_{off}$ ,  $t_{d(off)}$ ,  $t_f$

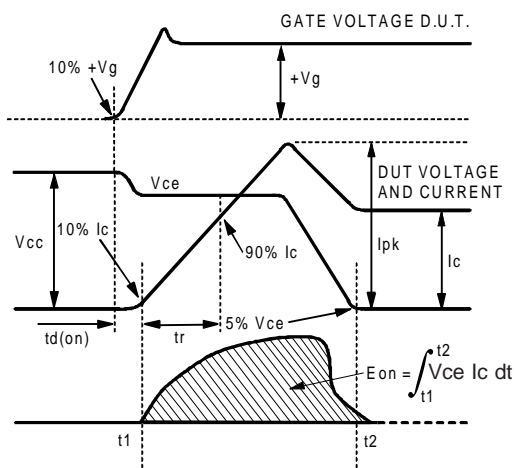

**Fig. 18c** - Test Waveforms for Circuit of Fig. 18a, Defining  $E_{on}$ ,  $t_{d(on)}$ ,  $t_r$

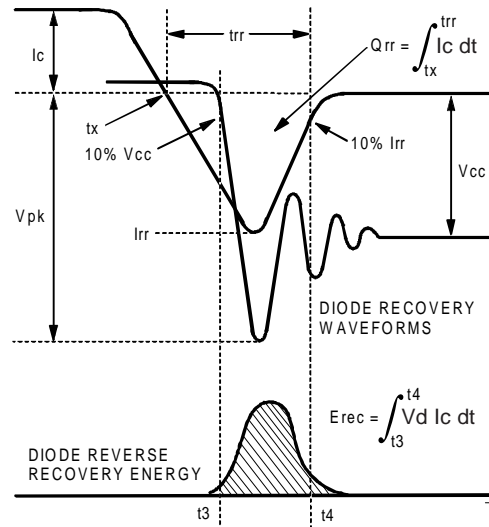

**Fig. 18d** - Test Waveforms for Circuit of Fig. 18a, Defining  $E_{rec}$ ,  $t_{rr}$ ,  $Q_{rr}$ ,  $I_{rr}$



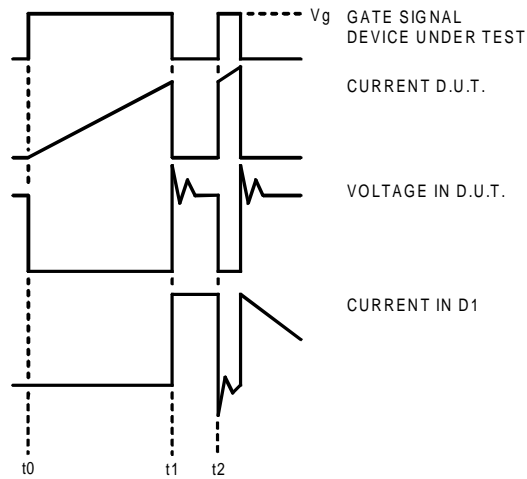

Figure 18e. Macro Waveforms for Figure 18a's Test Circuit

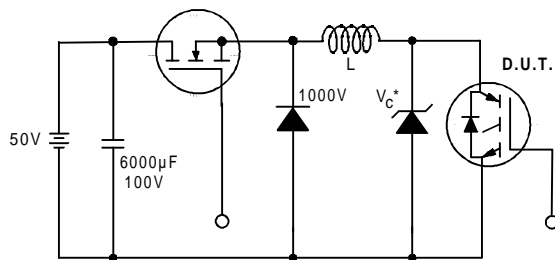

Figure 19. Clamped Inductive Load Test Circuit

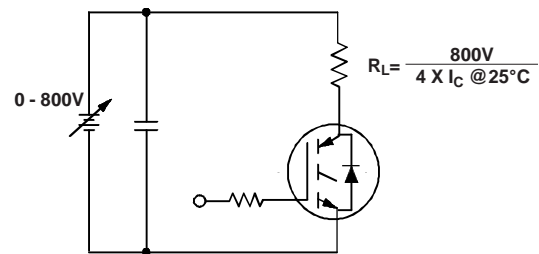

Figure 20. Pulsed Collector Current Test Circuit

# IRG4PSH71KD

International  
**IR** Rectifier

## Notes:

- ① Repetitive rating:  $V_{GE}=20V$ ; pulse width limited by maximum junction temperature (figure 20)
- ②  $V_{CC}=80\%(V_{CES})$ ,  $V_{GE}=20V$ ,  $L=10\mu H$ ,  $R_G=5.0\Omega$  (figure 19)
- ③ Pulse width  $\leq 80\mu s$ ; duty factor  $\leq 0.1\%$
- ④ Pulse width  $5.0\mu s$ , single shot

## Case Outline and Dimensions — Super-247

Dimensions are shown in millimeters

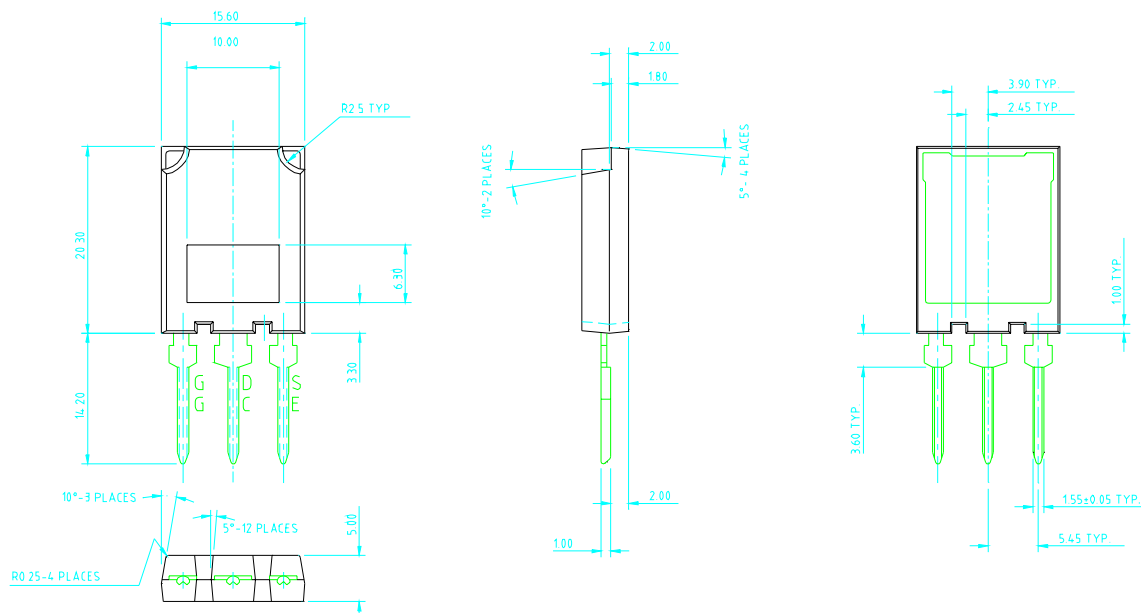

International  
**IR** Rectifier

**WORLD HEADQUARTERS:** 233 Kansas St., El Segundo, California 90245, Tel: (310) 322 3331

**IR GREAT BRITAIN:** Hurst Green, Oxted, Surrey RH8 9BB, UK Tel: ++ 44 1883 732020

**IR CANADA:** 15 Lincoln Court, Brampton, Ontario L6T3Z2, Tel: (905) 453 2200

**IR GERMANY:** Saalburgstrasse 157, 61350 Bad Homburg Tel: ++ 49 6172 96590

**IR ITALY:** Via Liguria 49, 10071 Borgaro, Torino Tel: ++ 39 11 451 0111

**IR FAR EAST:** K&H Bldg., 2F, 30-4 Nishi-Ikebukuro 3-Chome, Toshima-Ku, Tokyo Japan 171 Tel: 81 3 3983 0086

**IR SOUTHEAST ASIA:** 1 Kim Seng Promenade, Great World City West Tower, 13-11, Singapore 237994 Tel: ++ 65 838 4630

**IR TAIWAN:** 16 Fl. Suite D. 207, Sec. 2, Tun Haw South Road, Taipei, 10673, Taiwan Tel: 886-2-2377-9936

<http://www.irf.com/> Data and specifications subject to change without notice. 5/99