

**Thunderbolt IGBT®**

The Thunderbolt IGBT® is a new generation of high voltage power IGBTs. Using Non-Punch-Through Technology, the Thunderbolt IGBT® offers superior ruggedness and ultrafast switching speed.

**Features**

- Low Forward Voltage Drop
- Low Tail Current
- RoHS Compliant 
- RBSOA and SCSOA Rated
- High Frequency Switching to 50KHz
- Ultra Low Leakage Current

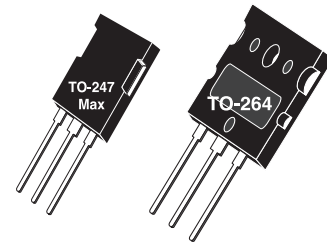

Unless stated otherwise, Microsemi discrete IGBTs contain a single IGBT die. This device is made with two parallel IGBT die. It is intended for switch-mode operation. It is not suitable for linear mode operation.

**Maximum Ratings**

 All Ratings:  $T_C = 25^\circ C$  unless otherwise specified.

Symbol	Parameter	Ratings	Unit
$V_{CES}$	Collector-Emitter Voltage	1200	Volts
$V_{GE}$	Gate-Emitter Voltage	$\pm 30$	
$I_{C1}$	Continuous Collector Current @ $T_C = 25^\circ C$	94	Amps
$I_{C2}$	Continuous Collector Current @ $T_C = 100^\circ C$	50	
$I_{CM}$	Pulsed Collector Current <sup>①</sup>	150	
SSOA	Switching Safe Operating Area @ $T_J = 150^\circ C$	150A @ 1200V	
$P_D$	Total Power Dissipation	625	Watts
$T_J, T_{STG}$	Operating and Storage Junction Temperature Range	-55 to 150	$^\circ C$
$T_L$	Max. Lead Temp. for Soldering: 0.063" from Case for 10 Sec.	300	

**Static Electrical Characteristics**

Symbol	Characteristic / Test Conditions	Min	Typ	Max	Unit
$V_{(BR)CES}$	Collector-Emitter Breakdown Voltage ( $V_{GE} = 0V, I_C = 3mA$ )	1200	-	-	Volts
$V_{GE(TH)}$	Gate Threshold Voltage ( $V_{CE} = V_{GE}, I_C = 2mA, T_J = 25^\circ C$ )	4.5	5.5	6.5	
$V_{CE(ON)}$	Collector Emitter On Voltage ( $V_{GE} = 15V, I_C = 50A, T_J = 25^\circ C$ )	2.7	3.2	3.7	
	Collector Emitter On Voltage ( $V_{GE} = 15V, I_C = 50A, T_J = 125^\circ C$ )	-	4.0	-	
$I_{CES}$	Collector Cut-off Current ( $V_{CE} = 1200V, V_{GE} = 0V, T_J = 25^\circ C$ ) <sup>②</sup>	-	-	200	$\mu A$
	Collector Cut-off Current ( $V_{CE} = 1200V, V_{GE} = 0V, T_J = 125^\circ C$ ) <sup>②</sup>	-	-	2.0	mA
$I_{GES}$	Gate-Emitter Leakage Current ( $V_{GE} = \pm 20V$ )	-	-	300	nA

 CAUTION: These Devices are Sensitive to Electrostatic Discharge. Proper Handling Procedures Should Be Followed.

## Dynamic Characteristics

APT50GT120B2R\_LR(G)

Symbol	Characteristic	Test Conditions	Min	Typ	Max	Unit
$C_{ies}$	Input Capacitance	$V_{GE} = 0V, V_{CE} = 25V$ $f = 1MHz$	-	3300	-	pF
$C_{oes}$	Output Capacitance		-	500	-	
$C_{res}$	Reverse Transfer Capacitance		-	220	-	
$V_{GEP}$	Gate-to-Emitter Plateau Voltage	Gate Charge $V_{GE} = 15V$ $V_{CE} = 600V$ $I_C = 50A$	-	10.5	-	V
$Q_g$	Total Gate Charge		-	340	-	nC
$Q_{ge}$	Gate-Emitter Charge		-	40	-	
$Q_{gc}$	Gate-Collector Charge		-	210	-	
SSOA	Switching Safe Operating Area	$T_J = 150^\circ C, R_G = 1.0\Omega^{(2)}, V_{GE} = 15V,$ $L = 100\mu H, V_{CE} = 1200V$	150			A
$t_{d(on)}$	Turn-On Delay Time	Inductive Switching ( $25^\circ C$ ) $V_{CC} = 800V$ $V_{GE} = 15V$ $I_C = 50A$ $R_G = 4.7\Omega$ $T_J = +25^\circ C$	-	24	-	ns
$t_r$	Current Rise Time		-	53	-	
$t_{d(off)}$	Turn-Off Delay Time		-	230	-	
$t_f$	Current Fall Time		-	26	-	$\mu J$
$E_{on1}$	Turn-On Switching Energy <sup>(4)</sup>		-	TBD	-	
$E_{on2}$	Turn-On Switching Energy <sup>(5)</sup>		-	5330	-	
$E_{off}$	Turn-Off Switching Energy <sup>(6)</sup>	-	2330	-		
$t_{d(on)}$	Turn-On Delay Time	Inductive Switching ( $125^\circ C$ ) $V_{CC} = 800V$ $V_{GE} = 15V$ $I_C = 50A$ $R_G = 4.7\Omega$ $T_J = 125^\circ C$	-	24	-	ns
$t_r$	Current Rise Time		-	53	-	
$t_{d(off)}$	Turn-Off Delay Time		-	255	-	
$t_f$	Current Fall Time		-	48	-	$\mu J$
$E_{on1}$	Turn-On Switching Energy <sup>(4)</sup>		-	TBD	-	
$E_{on2}$	Turn-On Switching Energy <sup>(5)</sup>		-	5670	-	
$E_{off}$	Turn-Off Switching Energy <sup>(6)</sup>	-	2850	-		

## Thermal and Mechanical Characteristics

Symbol	Characteristic / Test Conditions	Min	Typ	Max	Unit
$R_{\theta JC}$	Junction to Case	-	-	0.20	$^\circ C/W$
$W_T$	Package Weight	-	-	5.9	gm

① Repetitive Rating: Pulse width limited by maximum junction temperature.

② For Combi devices,  $I_{ces}$  includes both IGBT and FRED leakages

③ See MIL-STD-750 Method 3471.

④  $E_{on1}$  is the clamped inductive turn-on energy of the IGBT only, without the effect of a commutating diode reverse recovery current adding to the IGBT turn-on loss. Tested in inductive switching test circuit shown in figure 21, but with a Silicon Carbide diode.

⑤  $E_{on2}$  is the clamped inductive turn-on energy that includes a commutating diode reverse recovery current in the IGBT turn-on switching loss. (See Figures 21, 22.)

⑥  $E_{off}$  is the clamped inductive turn-off energy measured in accordance with JEDEC standard JESD24-1. (See Figures 21, 23.)

⑦  $R_G$  is external gate resistance not including gate driver impedance.

Microsemi reserves the right to change, without notice, the specifications and information contained herein.

Typical Performance Curves

APT50GT120B2R\_LR(G)

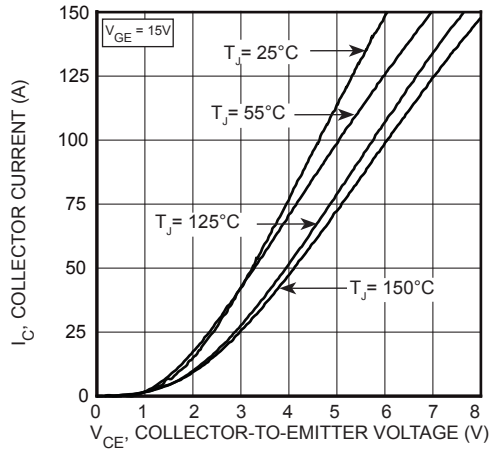

FIGURE 1, Output Characteristics ( $T_J = 25^\circ\text{C}$ )

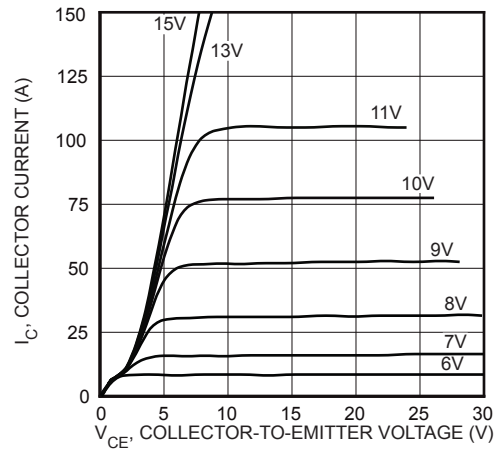

FIGURE 2, Output Characteristics ( $T_J = 25^\circ\text{C}$ )

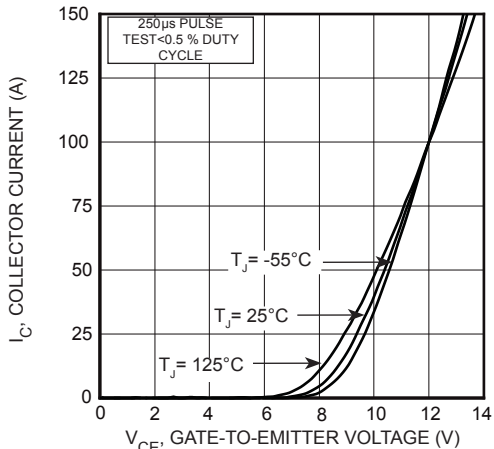

FIGURE 3, Transfer Characteristics

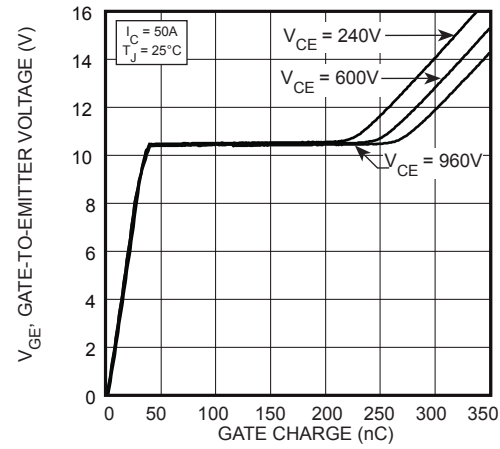

FIGURE 4, Gate charge

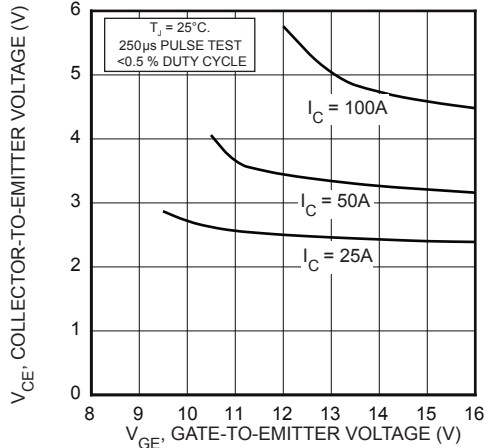

FIGURE 5, On State Voltage vs Gate-to-Emitter Voltage

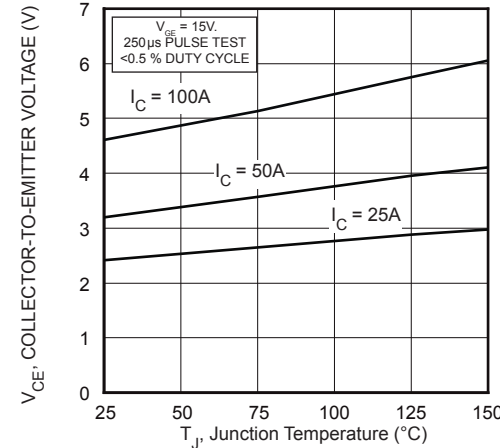

FIGURE 6, On State Voltage vs Junction Temperature

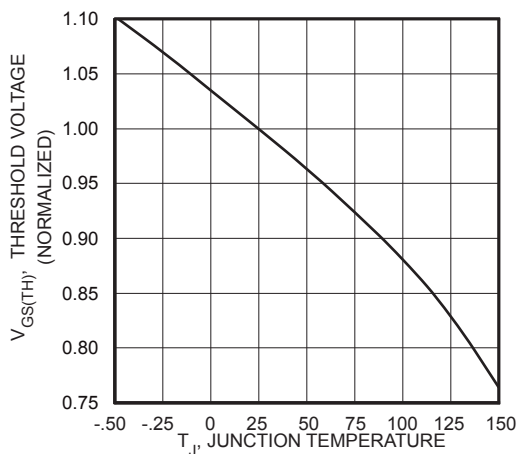

FIGURE 7, Threshold Voltage vs Junction Temperature

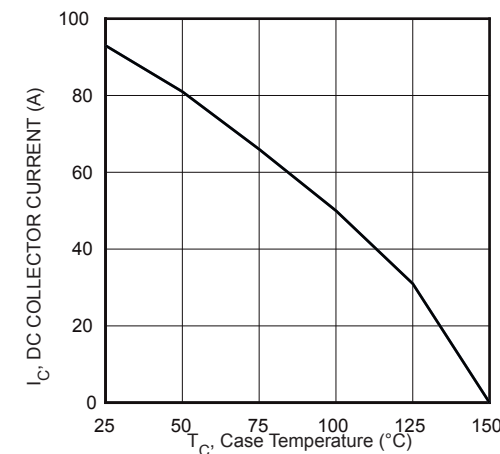

FIGURE 8, DC Collector Current vs Case Temperature

# Typical Performance Curves

APT50GT120B2R\_LR(G)

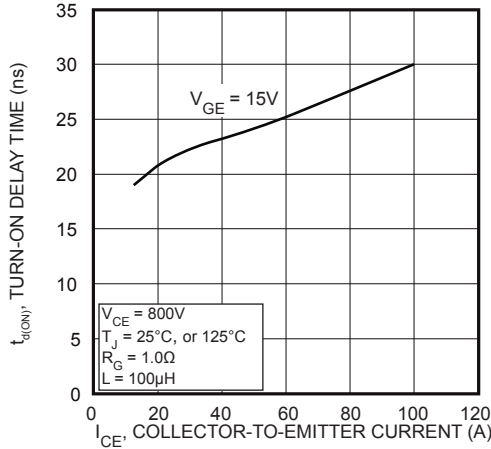

FIGURE 9, Turn-On Delay Time vs Collector Current

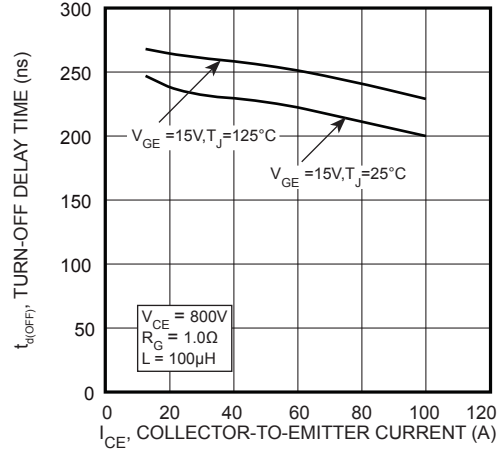

FIGURE 10, Turn-Off Delay Time vs Collector Current

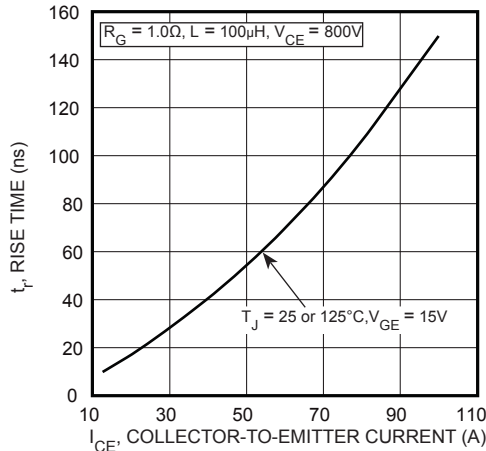

FIGURE 11, Current Rise Time vs Collector Current

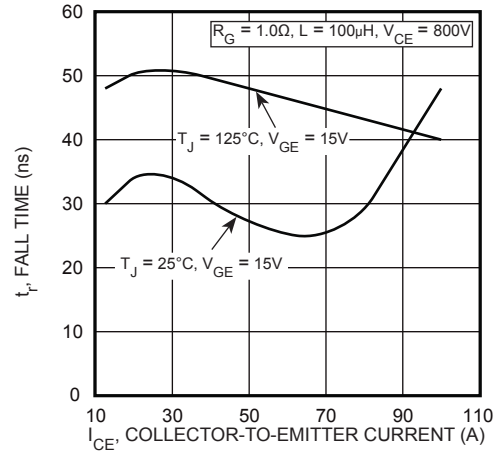

FIGURE 12, Current Fall Time vs Collector Current

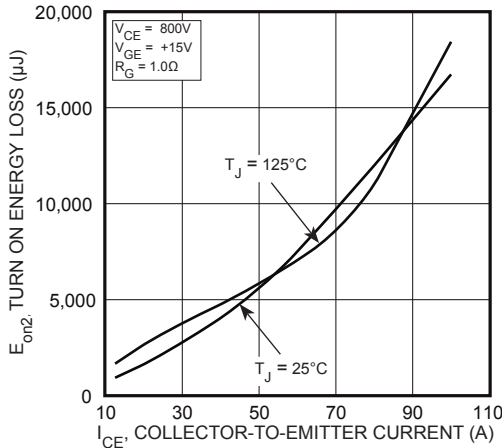

FIGURE 13, Turn-On Energy Loss vs Collector Current

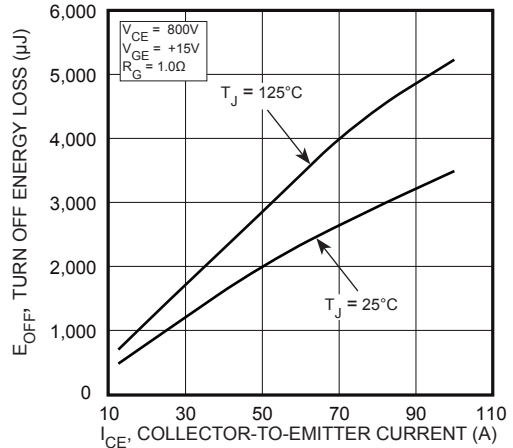

FIGURE 14, Turn-Off Energy Loss vs Collector Current

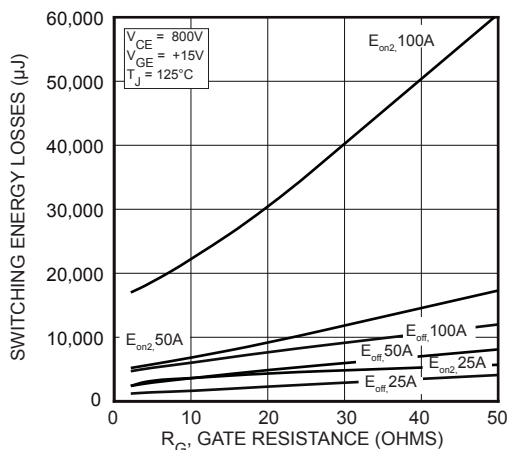

FIGURE 15, Switching Energy Losses vs Gate Resistance

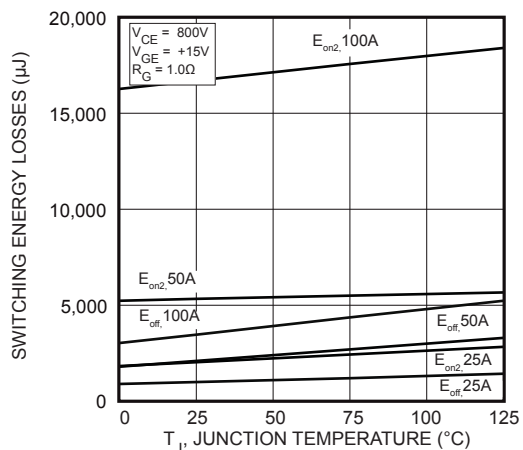

FIGURE 16, Switching Energy Losses vs Junction Temperature

Typical Performance Curves

APT50GT120B2R\_LR(G)

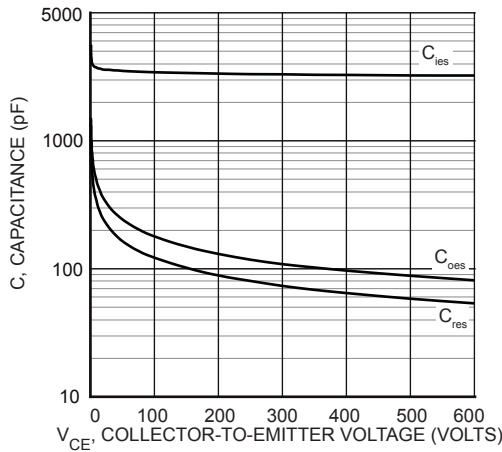

FIGURE 17, Capacitance vs Collector-To-Emitter Voltage

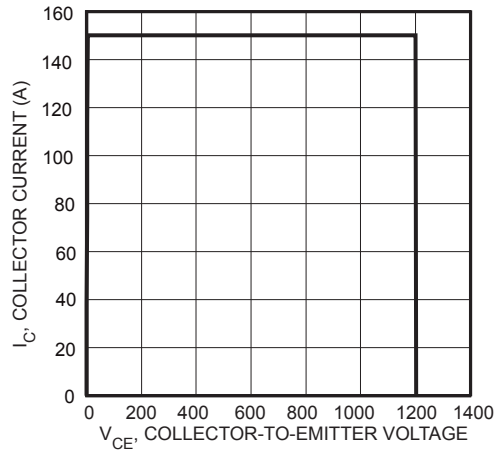

FIGURE 18, Minimum Switching Safe Operating Area

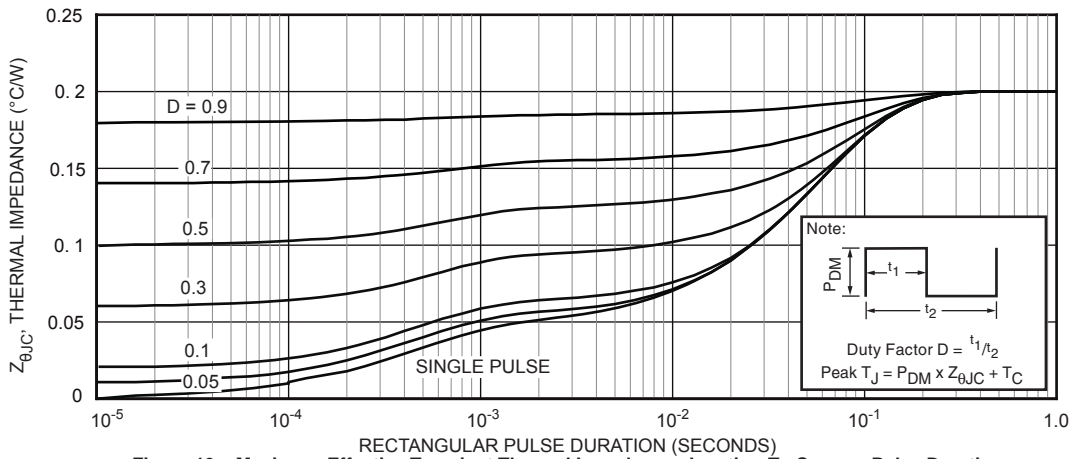

Figure 19a, Maximum Effective Transient Thermal Impedance, Junction-To-Case vs Pulse Duration

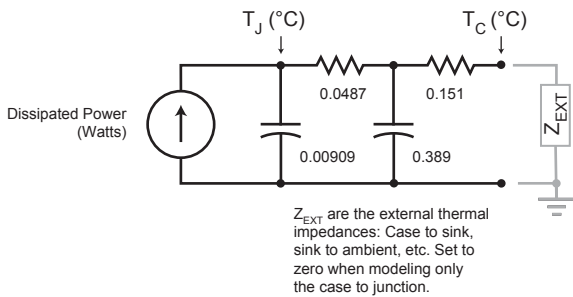

FIGURE 19b, TRANSIENT THERMAL IMPEDANCE MODEL

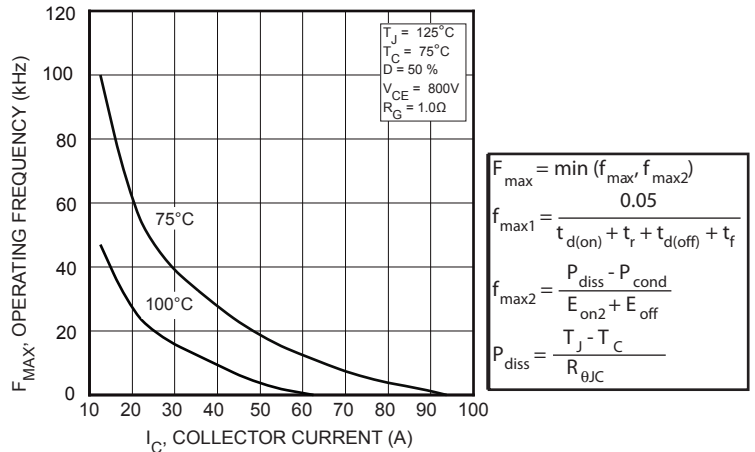

Figure 20, Operating Frequency vs Collector Current

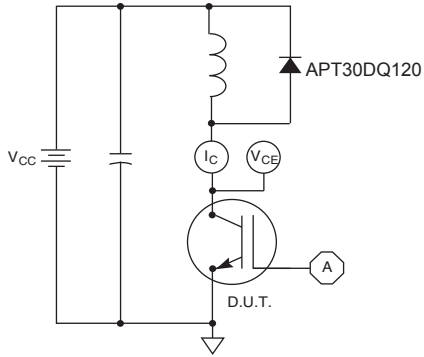

Figure 21, Inductive Switching Test Circuit

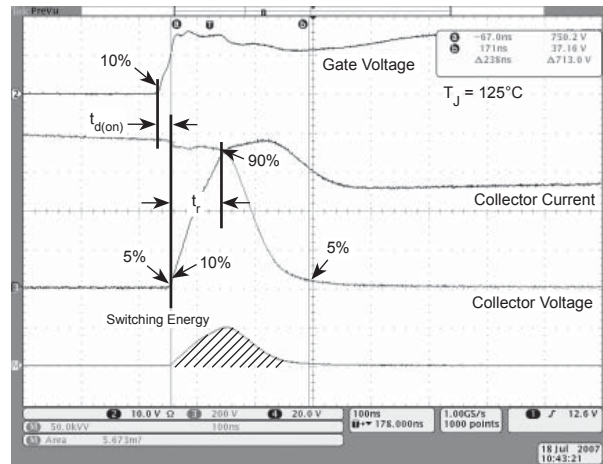

Figure 22, Turn-on Switching Waveforms and Definitions

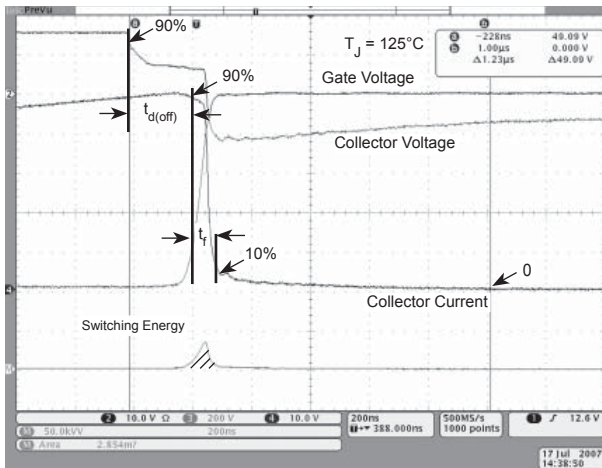
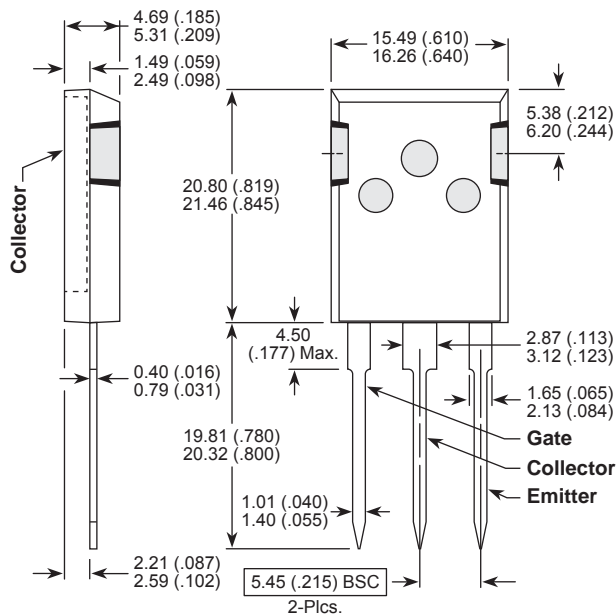

Figure 23, Turn-off Switching Waveforms and Definitions

T-MAX® Package Outline



Dimensions in Millimeters and (Inches)

TO-264 Package Outline

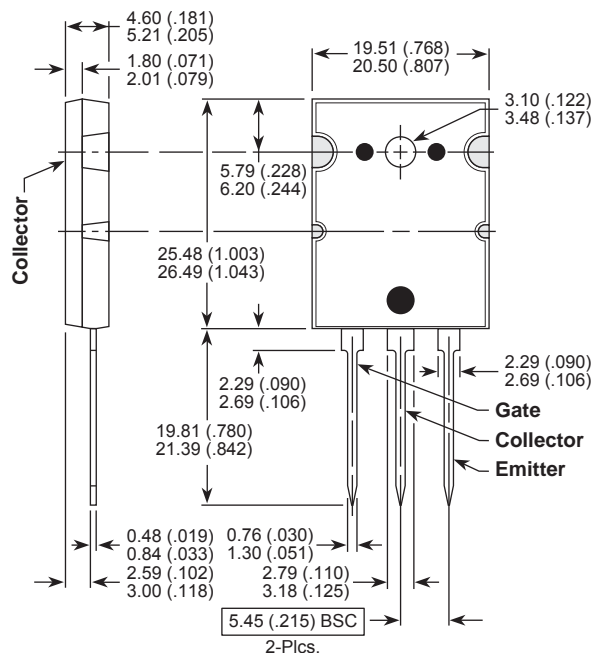

Dimensions in Millimeters and (Inches)