

Resonant Mode Combi IGBT®

The Thunderbolt IGBT® used in this Resonant Mode Combi is a new generation of high voltage power IGBTs. Using Non-Punch Through Technology, the Thunderbolt IGBT® offers superior ruggedness and ultrafast switching speed.

Features

- Low Conduction Loss
- Low Gate Charge
- Ultrafast Tail Current shutoff
- Low forward Diode Voltage (V_F)
- Ultrasoft Recovery Diode

- SSOA Rated
- RoHS Compliant 

Typical Applications

- Induction Heating
- Welding
- Medical
- High Power Telecom
- Resonant Mode Phase Shifted Bridge

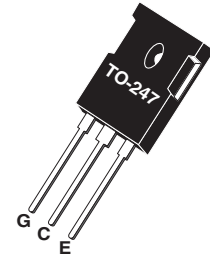

MAXIMUM RATINGS

All Ratings: $T_C = 25^\circ\text{C}$ unless otherwise specified.

Symbol	Parameter	APT50GT60BRDL(G)	UNIT
V_{CES}	Collector-Emitter Voltage	600	Volts
V_{GE}	Gate-Emitter Voltage	± 30	
I_{C1}	Continuous Collector Current ⁽⁷⁾ @ $T_C = 25^\circ\text{C}$	110	Amps
I_{C2}	Continuous Collector Current @ $T_C = 110^\circ\text{C}$	52	
I_{CM}	Pulsed Collector Current ⁽¹⁾ @ $T_C = 150^\circ\text{C}$	150	
SSOA	Switching Safe Operating Area @ $T_J = 150^\circ\text{C}$	150A @ 600V	
P_D	Total Power Dissipation	446	Watts
T_J, T_{STG}	Operating and Storage Junction Temperature Range	-55 to 150	$^\circ\text{C}$
T_L	Max. Lead Temp. for Soldering: 0.063" from Case for 10 Sec.	300	

STATIC ELECTRICAL CHARACTERISTICS

Symbol	Characteristic / Test Conditions	MIN	TYP	MAX	Units
$V_{(BR)CES}$	Collector-Emitter Breakdown Voltage ($V_{GE} = 0V, I_C = 2mA$)	600			Volts
$V_{GE(TH)}$	Gate Threshold Voltage ($V_{CE} = V_{GE}, I_C = 1mA, T_J = 25^\circ\text{C}$)	3	4	5	
$V_{CE(ON)}$	Collector-Emitter On Voltage ($V_{GE} = 15V, I_C = 50A, T_J = 25^\circ\text{C}$)	1.7	2.0	2.5	
	Collector-Emitter On Voltage ($V_{GE} = 15V, I_C = 50A, T_J = 125^\circ\text{C}$)		2.2		
I_{CES}	Collector Cut-off Current ($V_{CE} = 600V, V_{GE} = 0V, T_J = 25^\circ\text{C}$) ⁽²⁾			50	μA
	Collector Cut-off Current ($V_{CE} = 600V, V_{GE} = 0V, T_J = 125^\circ\text{C}$) ⁽²⁾			1250	
I_{GES}	Gate-Emitter Leakage Current ($V_{GE} = \pm 20V$)			120	nA

 **CAUTION:** These Devices are Sensitive to Electrostatic Discharge. Proper Handling Procedures Should Be Followed.

DYNAMIC CHARACTERISTICS

APT50GT60BRDL(G)

Symbol	Characteristic	Test Conditions	MIN	TYP	MAX	UNIT	
C_{ies}	Input Capacitance	Capacitance $V_{GE} = 0V, V_{CE} = 25V$ $f = 1 \text{ MHz}$		2500		pF	
C_{oes}	Output Capacitance			250			
C_{res}	Reverse Transfer Capacitance			155			
V_{GEP}	Gate-to-Emitter Plateau Voltage	Gate Charge		7.5		V	
Q_g	Total Gate Charge ^③	$V_{GE} = 15V$ $V_{CE} = 300V$ $I_C = 50A$		240		nC	
Q_{ge}	Gate-Emitter Charge			20			
Q_{gc}	Gate-Collector ("Miller") Charge			110			
SSOA	Switching Safe Operating Area	$T_J = 150^\circ C, R_G = 5\Omega, V_{GE} = 15V, L = 100\mu H, V_{CE} = 600V$	150			A	
$t_{d(on)}$	Turn-on Delay Time	Inductive Switching (25°C) $V_{CC} = 400V$ $V_{GE} = 15V$ $I_C = 50A$ $R_G = 5\Omega$ $T_J = +25^\circ C$		14		ns	
t_r	Current Rise Time			32			
$t_{d(off)}$	Turn-off Delay Time			240			
t_f	Current Fall Time			36			
E_{on1}	Turn-on Switching Energy ^④			995			μJ
E_{on2}	Turn-on Switching Energy (Diode) ^⑤		1110				
E_{off}	Turn-off Switching Energy ^⑥		1070				
$t_{d(on)}$	Turn-on Delay Time	Inductive Switching (125°C) $V_{CC} = 400V$ $V_{GE} = 15V$ $I_C = 50A$ $R_G = 5\Omega$ $T_J = +125^\circ C$		14		ns	
t_r	Current Rise Time			32			
$t_{d(off)}$	Turn-off Delay Time			270			
t_f	Current Fall Time			95			
E_{on1}	Turn-on Switching Energy ^④			1035			μJ
E_{on2}	Turn-on Switching Energy (Diode) ^⑤			1655			
E_{off}	Turn-off Switching Energy ^⑥			1505			

THERMAL AND MECHANICAL CHARACTERISTICS

Symbol	Characteristic	MIN	TYP	MAX	UNIT
$R_{\theta JC}$	Junction to Case (IGBT)			.28	°C/W
$R_{\theta JC}$	Junction to Case (DIODE)			.61	
W_T	Package Weight		5.9		gm

- ① Repetitive Rating: Pulse width limited by maximum junction temperature.
- ② For Combi devices, I_{ces} includes both IGBT and FRED leakages
- ③ See MIL-STD-750 Method 3471.
- ④ E_{on1} is the clamped inductive turn-on energy of the IGBT only, without the effect of a commutating diode reverse recovery current adding to the IGBT turn-on loss. Tested in inductive switching test circuit shown in figure 21, but with a Silicon Carbide diode.
- ⑤ E_{on2} is the clamped inductive turn-on energy that includes a commutating diode reverse recovery current in the IGBT turn-on switching loss. (See Figures 21, 22.)
- ⑥ E_{off} is the clamped inductive turn-off energy measured in accordance with JEDEC standard JESD24-1. (See Figures 21, 23.)
- ⑦ Continuous current limited by package lead temperature.

Microsemi Reserves the right to change, without notice, the specifications and information contained herein.

TYPICAL PERFORMANCE CURVES

APT50GT60BRDL(G)

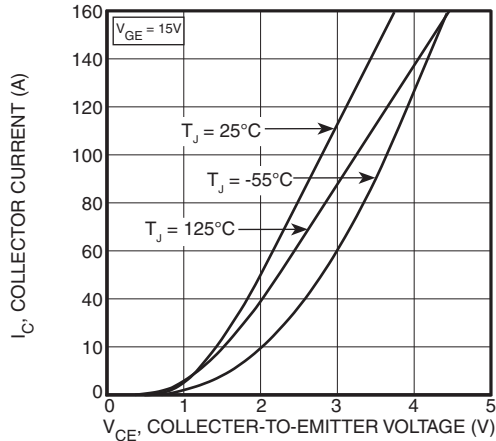

FIGURE 1, Output Characteristics ($T_J = 25^\circ\text{C}$)

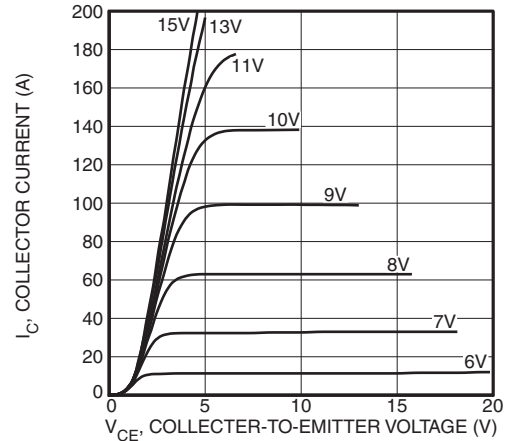

FIGURE 2, Output Characteristics ($T_J = 125^\circ\text{C}$)

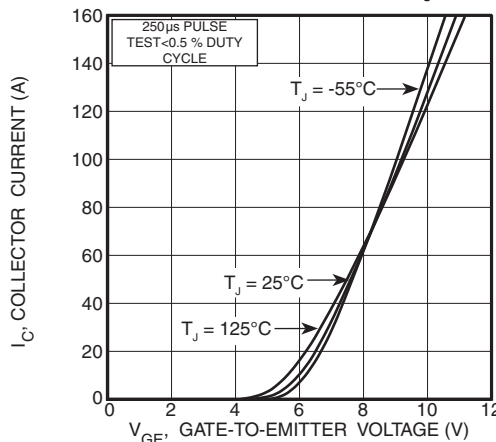

FIGURE 3, Transfer Characteristics

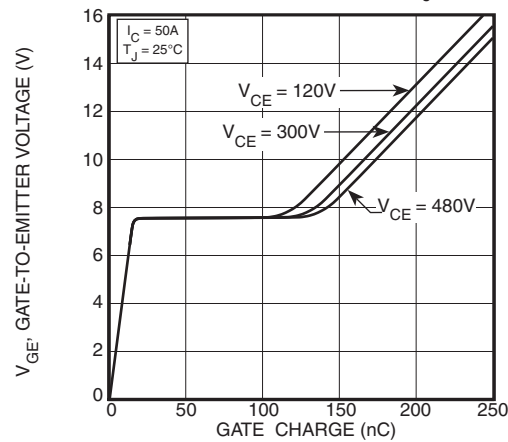

FIGURE 4, Gate Charge

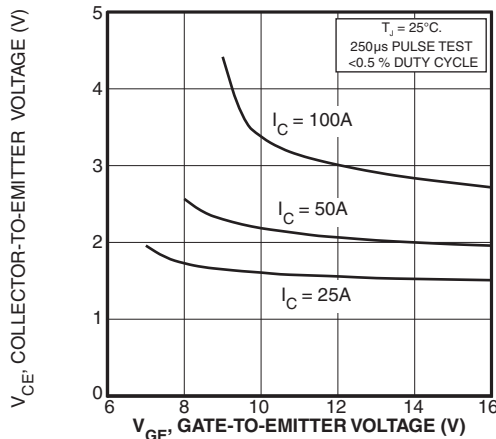

FIGURE 5, On State Voltage vs Gate-to-Emitter Voltage

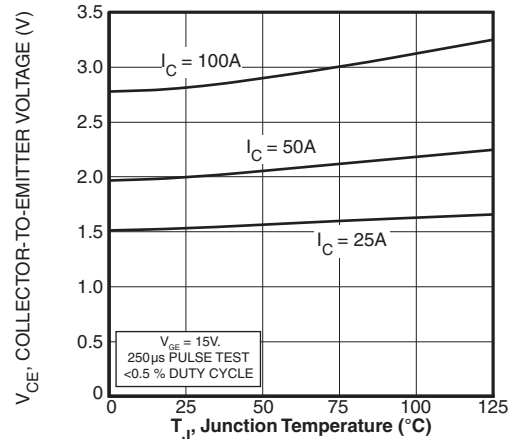

FIGURE 6, On State Voltage vs Junction Temperature

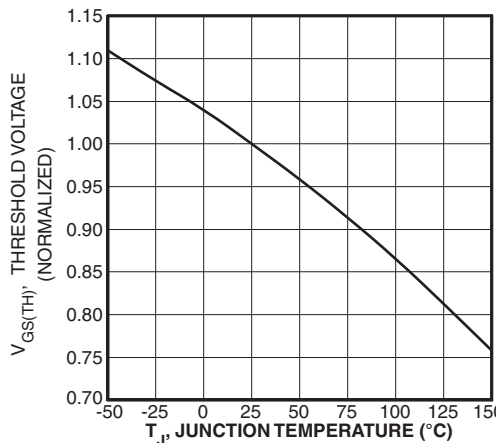

FIGURE 7, Threshold Voltage vs. Junction Temperature

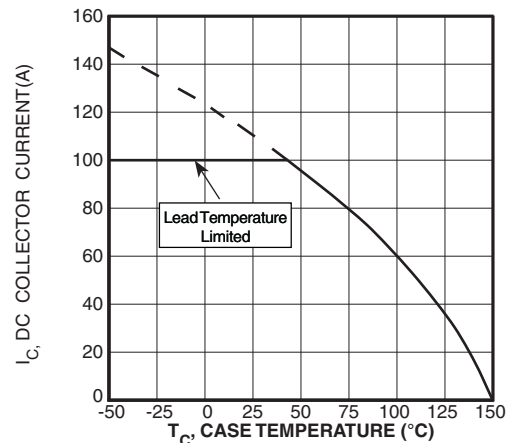

FIGURE 8, DC Collector Current vs Case Temperature

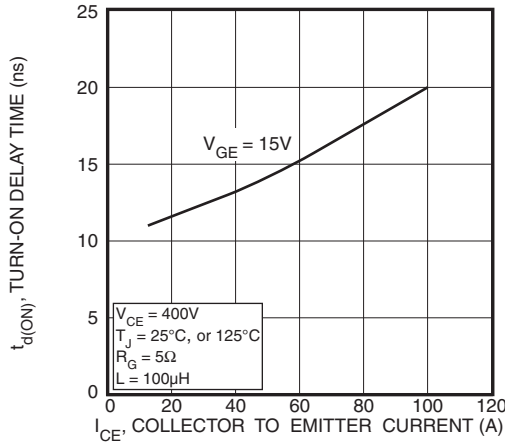

FIGURE 9, Turn-On Delay Time vs Collector Current

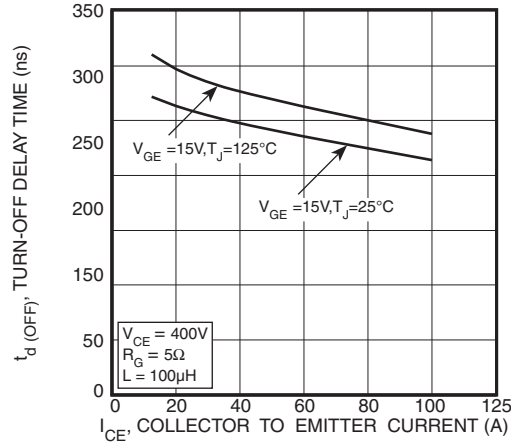

FIGURE 10, Turn-Off Delay Time vs Collector Current

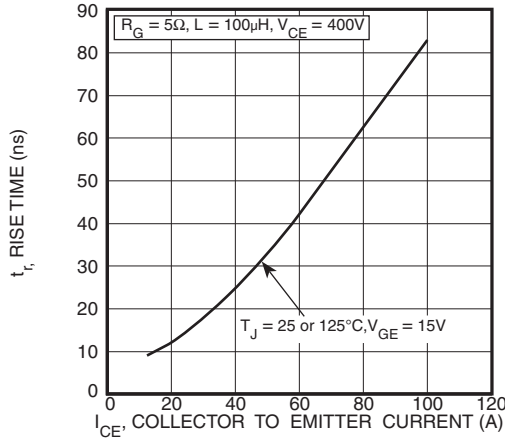

FIGURE 11, Current Rise Time vs Collector Current

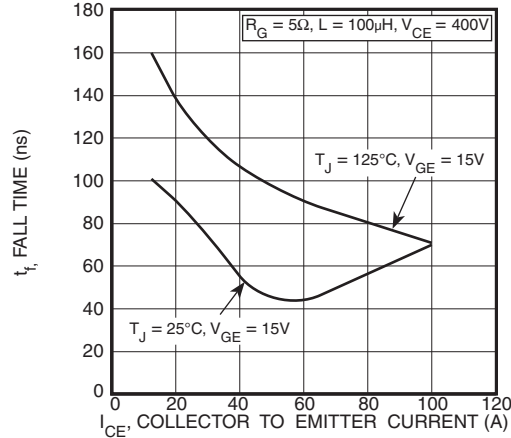

FIGURE 12, Current Fall Time vs Collector Current

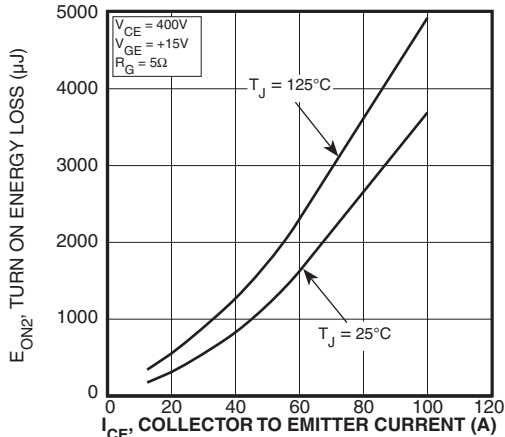

FIGURE 13, Turn-On Energy Loss vs Collector Current

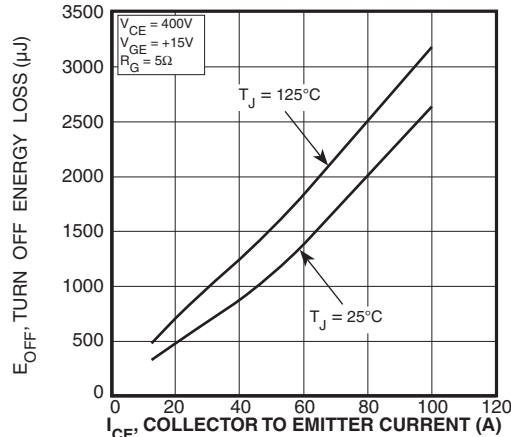

FIGURE 14, Turn Off Energy Loss vs Collector Current

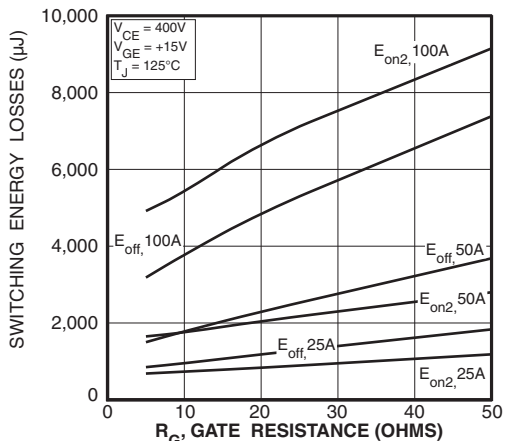

FIGURE 15, Switching Energy Losses vs. Gate Resistance

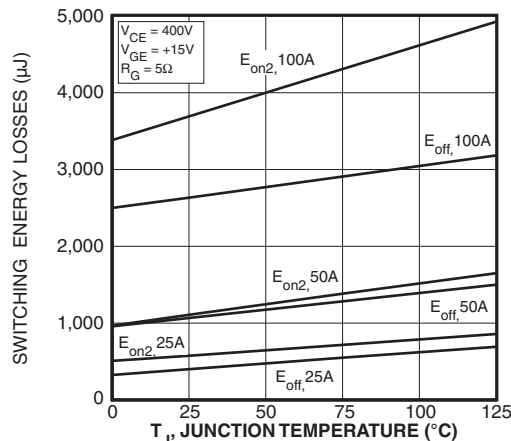

FIGURE 16, Switching Energy Losses vs Junction Temperature

TYPICAL PERFORMANCE CURVES

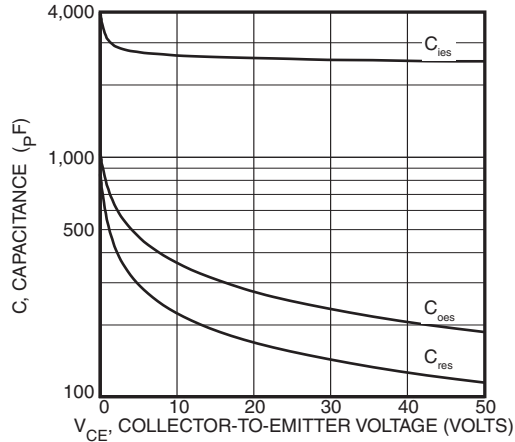

Figure 17, Capacitance vs Collector-To-Emitter Voltage

APT50GT60BRDL(G)

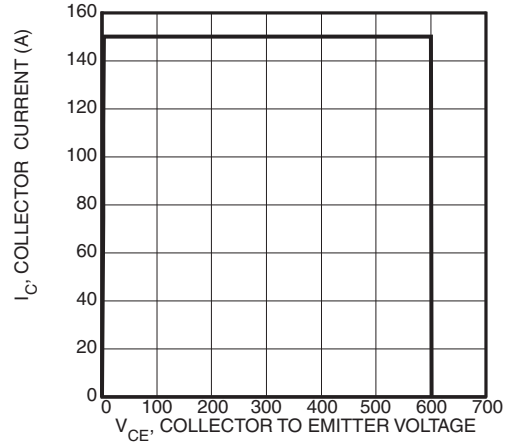

Figure 18, Minimum Switching Safe Operating Area

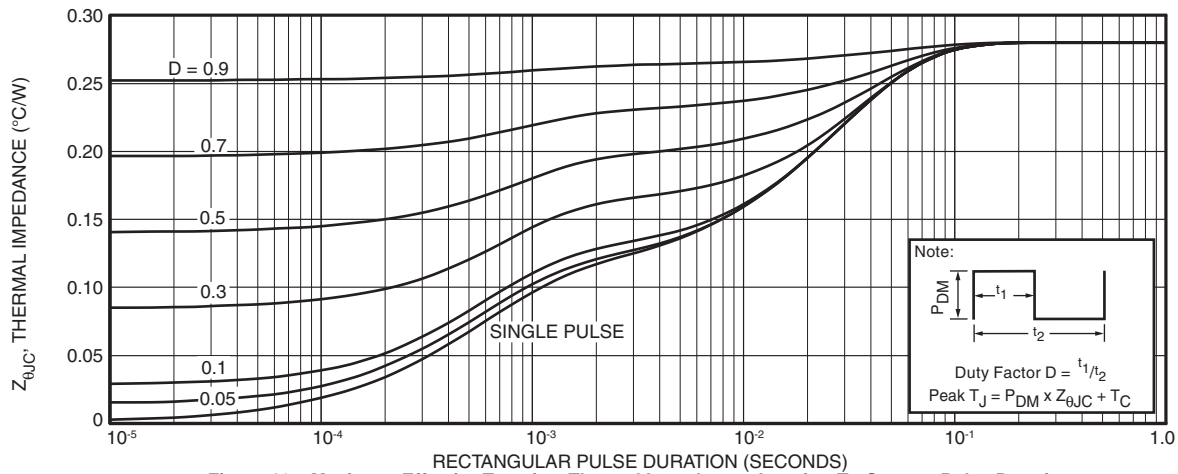

Figure 19a, Maximum Effective Transient Thermal Impedance, Junction-To-Case vs Pulse Duration

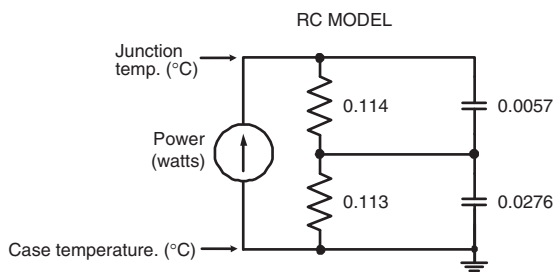

FIGURE 19b, TRANSIENT THERMAL IMPEDANCE MODEL

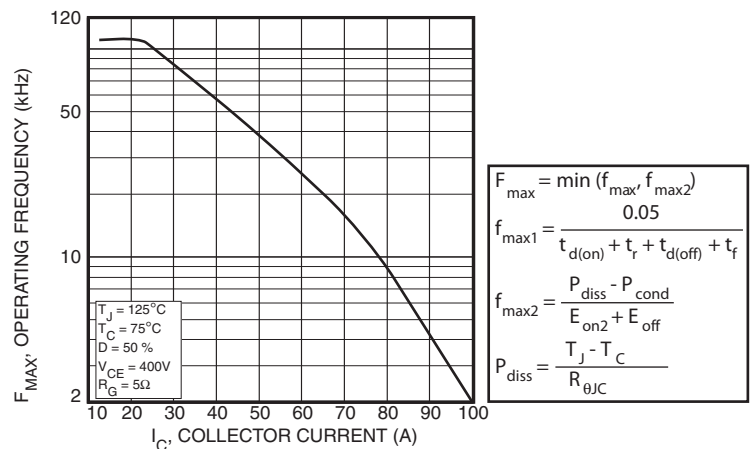

Figure 20, Operating Frequency vs Collector Current

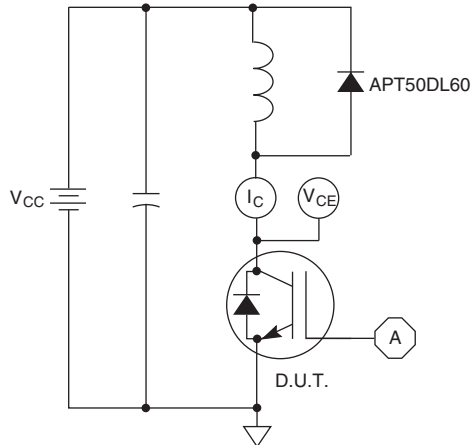

Figure 21, Inductive Switching Test Circuit

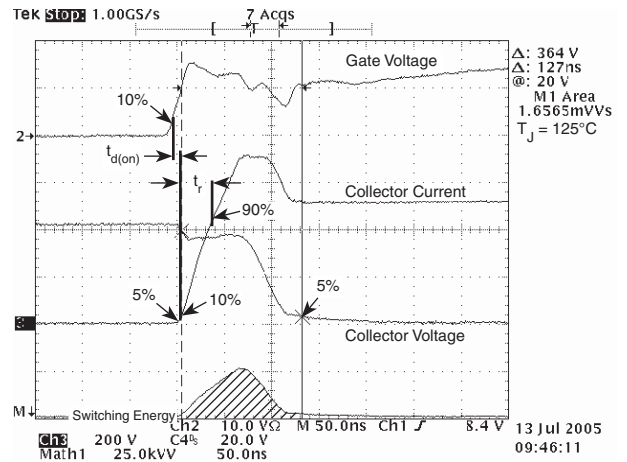

Figure 22, Turn-on Switching Waveforms and Definitions

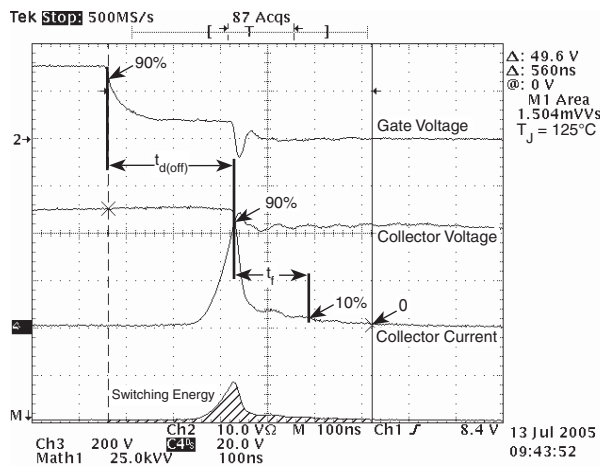

Figure 23, Turn-off Switching Waveforms and Definitions

ULTRAFAST SOFT RECOVERY ANTI-PARALLEL DIODE

MAXIMUM RATINGS

All Ratings: $T_C = 25^\circ\text{C}$ unless otherwise specified.

Symbol	Characteristic / Test Conditions	APT50GT60BRDL(G)		UNIT
$I_{F(AV)}$	Maximum Average Forward Current ($T_C = 100^\circ\text{C}$, Duty Cycle = 0.5)		50	Amps
$I_{F(RMS)}$	RMS Forward Current (Square wave, 50% duty)		150	
I_{FSM}	Non-Repetitive Forward Surge Current ($T_J = 45^\circ\text{C}$, 8.3ms)		320	

STATIC ELECTRICAL CHARACTERISTICS

Symbol	Characteristic / Test Conditions	MIN	TYP	MAX	UNIT	
V_F	Forward Voltage		$I_F = 50\text{A}$	1.25	1.6	Volts
			$I_F = 100\text{A}$	2.0		
			$I_F = 50\text{A}, T_J = 125^\circ\text{C}$	1.25		

DYNAMIC CHARACTERISTICS

Symbol	Characteristic	Test Conditions	MIN	TYP	MAX	UNIT
t_{rr}	Reverse Recovery Time	$I_F = 1\text{A}, di_F/dt = -100\text{A}/\mu\text{s}, V_R = 30\text{V}, T_J = 25^\circ\text{C}$	-	52		ns
t_{rr}	Reverse Recovery Time	$I_F = 50\text{A}, di_F/dt = -200\text{A}/\mu\text{s}, V_R = 400\text{V}, T_C = 25^\circ\text{C}$	-	399		
Q_{rr}	Reverse Recovery Charge		-	1498		nC
I_{RRM}	Maximum Reverse Recovery Current		-	9	-	Amps
t_{rr}	Reverse Recovery Time	$I_F = 50\text{A}, di_F/dt = -200\text{A}/\mu\text{s}, V_R = 400\text{V}, T_C = 125^\circ\text{C}$	-	649		ns
Q_{rr}	Reverse Recovery Charge		-	3734		nC
I_{RRM}	Maximum Reverse Recovery Current		-	13	-	Amps
t_{rr}	Reverse Recovery Time	$I_F = 50\text{A}, di_F/dt = -1000\text{A}/\mu\text{s}, V_R = 400\text{V}, T_C = 125^\circ\text{C}$	-	284		ns
Q_{rr}	Reverse Recovery Charge		-	5134		nC
I_{RRM}	Maximum Reverse Recovery Current		-	34		Amps

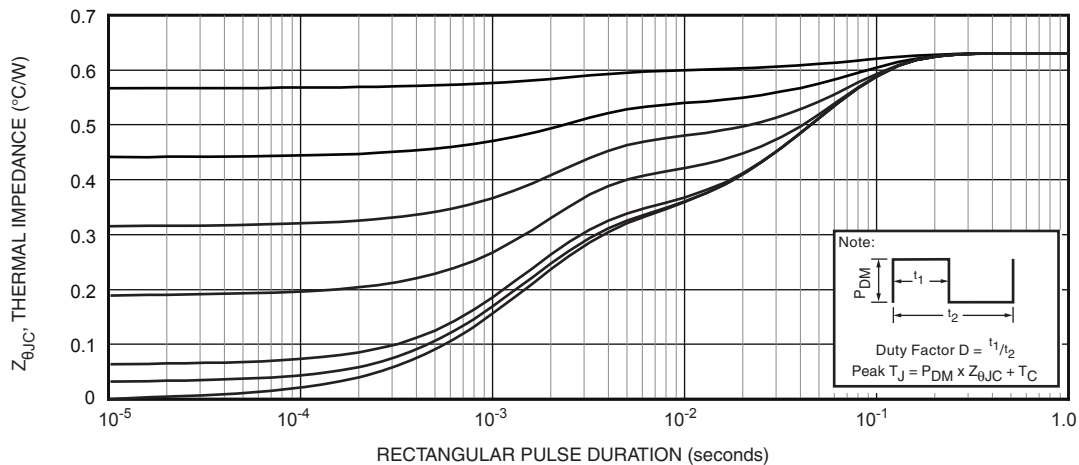

FIGURE 1a. MAXIMUM EFFECTIVE TRANSIENT THERMAL IMPEDANCE, JUNCTION-TO-CASE vs. PULSE DURATION

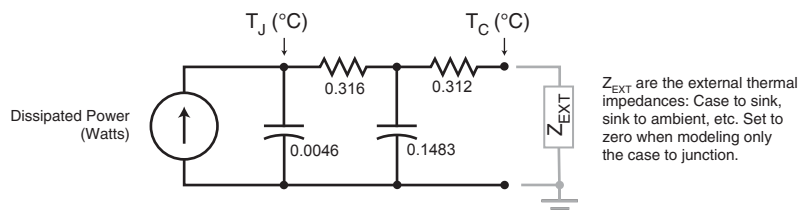

FIGURE 1b, TRANSIENT THERMAL IMPEDANCE MODEL

TYPICAL PERFORMANCE CURVES

APT50GT60BRDL(G)

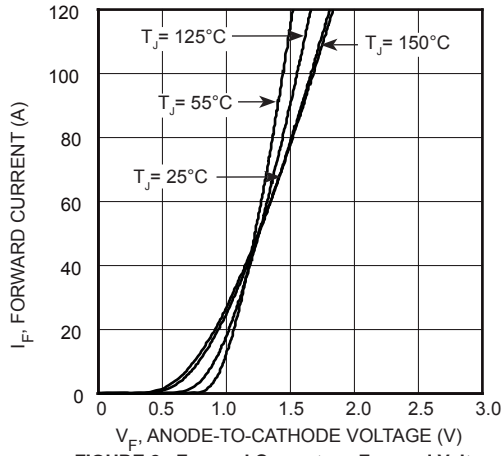

FIGURE 2, Forward Current vs. Forward Voltage

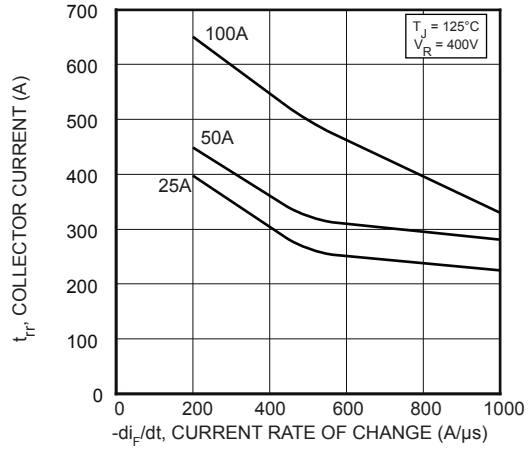

FIGURE 3, Reverse Recovery Time vs. Current Rate of Change

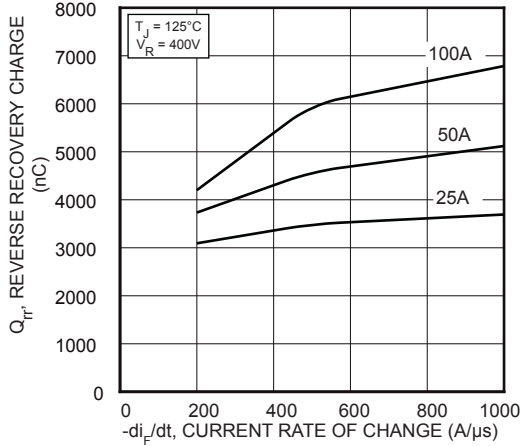

FIGURE 4, Reverse Recovery Charge vs. Current Rate of Change

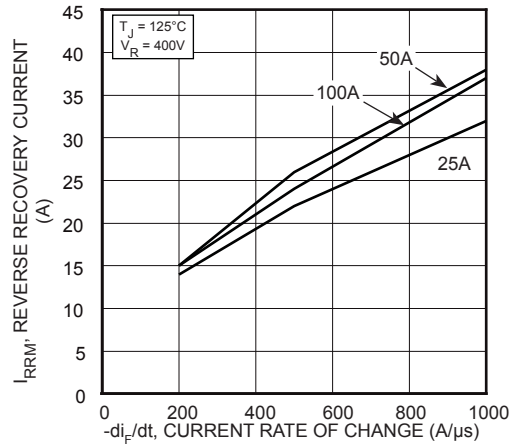

FIGURE 5, Reverse Recovery Current vs. Current Rate of Change

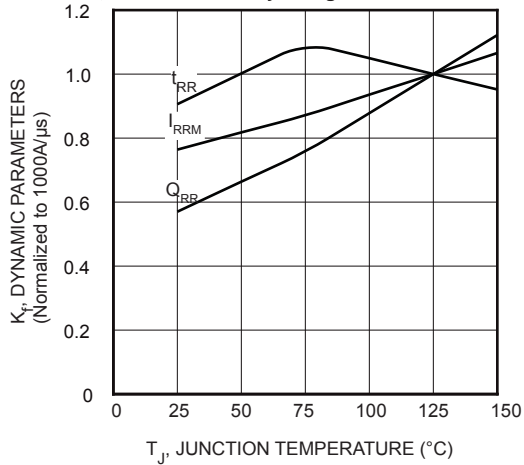

FIGURE 6, Dynamic Parameters vs. Junction Temperature

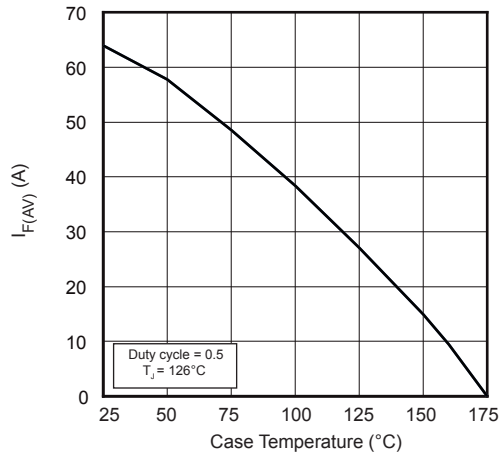

FIGURE 7, Maximum Average Forward Current vs. Case Temperature

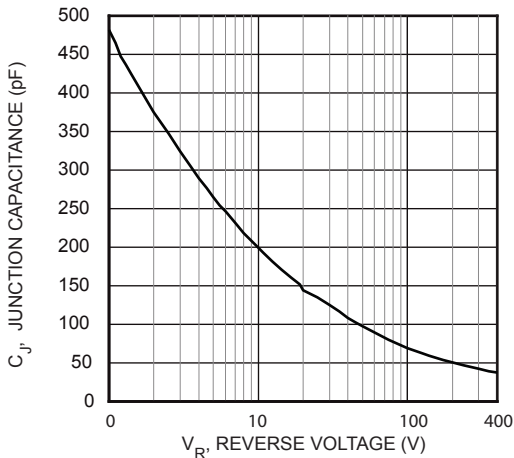

FIGURE 8, Junction Capacitance vs. Reverse Voltage

TYPICAL PERFORMANCE CURVES

APT50GT60BRDL(G)

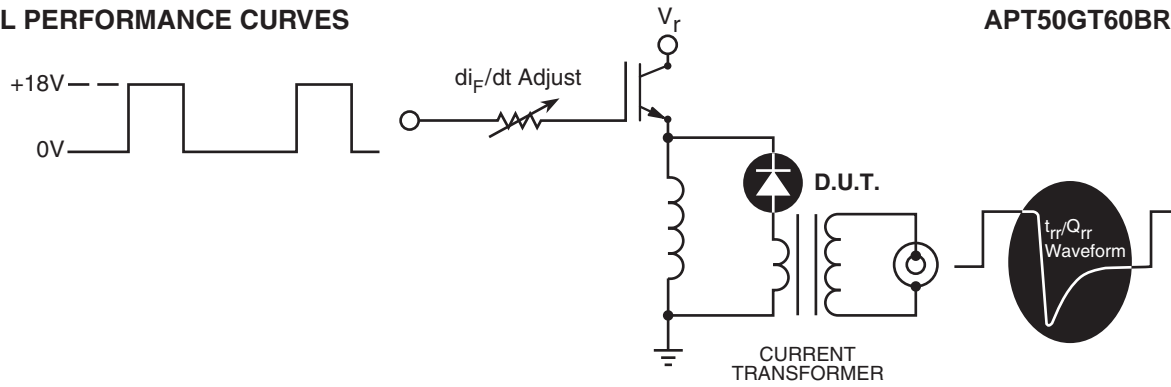

Figure 9. Diode Test Circuit

- 1 I_F - Forward Conduction Current
- 2 di_F/dt - Rate of Diode Current Change Through Zero Crossing.
- 3 I_{RRM} - Maximum Reverse Recovery Current.
- 4 t_{rr} - Reverse Recovery Time, measured from zero crossing where diode current goes from positive to negative, to the point at which the straight line through I_{RRM} and $0.25 \cdot I_{RRM}$ passes through zero.
- 5 Q_{rr} - Area Under the Curve Defined by I_{RRM} and t_{rr} .
- 6 di_M/dt - Maximum Rate of Current Increase During the Trailing Portion of t_{rr} .

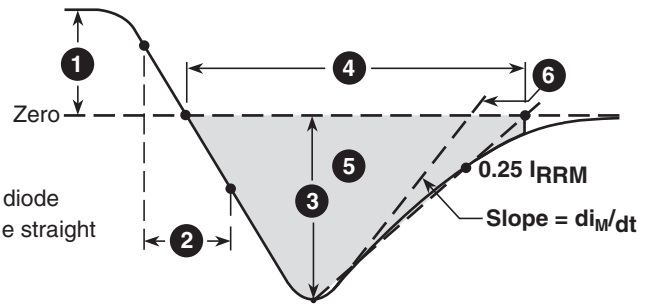
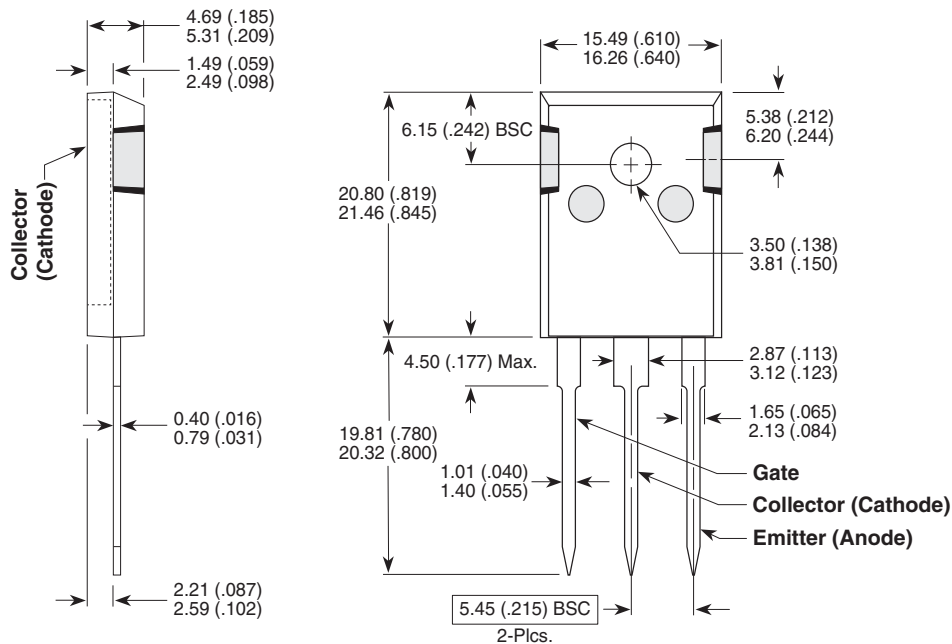

Figure 10, Diode Reverse Recovery Waveform and Definitions

TO-247 (B) Package Outline



Dimensions in Millimeters and (Inches)

Microsemi's products are covered by one or more of U.S. patents 4,895,810 5,045,903 5,089,434 5,182,234 5,019,522 5,262,336 6,503,786 5,256,583 4,748,103 5,283,202 5,231,474 5,434,095 5,528,058 6,939,743, 7,352,045 5,283,201 5,801,417 5,648,283 7,196,634 6,664,594 7,157,886 6,939,743 7,342,262 and foreign patents. US and Foreign patents pending. All Rights Reserved.