

## Thunderbolt IGBT®

The Thunderbolt IGBT® is a new generation of high voltage power IGBTs. Using Non-Punch Through Technology, the Thunderbolt IGBT® offers superior ruggedness and ultrafast switching speed.

- Low Forward Voltage Drop
- High Freq. Switching to 150KHz
- Low Tail Current
- Ultra Low Leakage Current
- RBSOA and SCSOA Rated

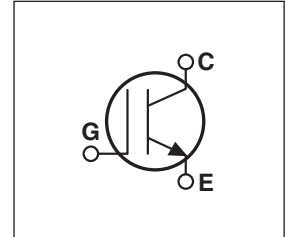
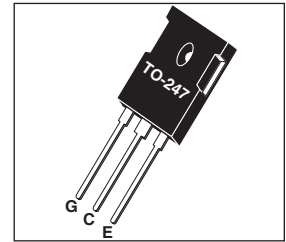

### MAXIMUM RATINGS

All Ratings:  $T_C = 25^\circ\text{C}$  unless otherwise specified.

Symbol	Parameter	APT15GT60BR(G)	UNIT
$V_{CES}$	Collector-Emitter Voltage	600	Volts
$V_{GE}$	Gate-Emitter Voltage	$\pm 30$	
$I_{C1}$	Continuous Collector Current @ $T_C = 25^\circ\text{C}$	42	Amps
$I_{C2}$	Continuous Collector Current @ $T_C = 110^\circ\text{C}$	20	
$I_{CM}$	Pulsed Collector Current <sup>①</sup>	45	
SSOA	Switching Safe Operating Area @ $T_J = 150^\circ\text{C}$	45A @ 600V	
$P_D$	Total Power Dissipation	184	Watts
$T_J, T_{STG}$	Operating and Storage Junction Temperature Range	-55 to 150	$^\circ\text{C}$
$T_L$	Max. Lead Temp. for Soldering: 0.063" from Case for 10 Sec.	300	

### STATIC ELECTRICAL CHARACTERISTICS

Symbol	Characteristic / Test Conditions	MIN	TYP	MAX	Units
$V_{(BR)CES}$	Collector-Emitter Breakdown Voltage ( $V_{GE} = 0\text{V}$ , $I_C = 250\mu\text{A}$ )	600			Volts
$V_{GE(TH)}$	Gate Threshold Voltage ( $V_{CE} = V_{GE}$ , $I_C = 700\mu\text{A}$ , $T_J = 25^\circ\text{C}$ )	3	4	5	
$V_{CE(ON)}$	Collector-Emitter On Voltage ( $V_{GE} = 15\text{V}$ , $I_C = 15\text{A}$ , $T_J = 25^\circ\text{C}$ )	1.6	2.0	2.5	
	Collector-Emitter On Voltage ( $V_{GE} = 15\text{V}$ , $I_C = 15\text{A}$ , $T_J = 125^\circ\text{C}$ )		2.8		
$I_{CES}$	Collector Cut-off Current ( $V_{CE} = 600\text{V}$ , $V_{GE} = 0\text{V}$ , $T_J = 25^\circ\text{C}$ ) <sup>②</sup>			25	$\mu\text{A}$
	Collector Cut-off Current ( $V_{CE} = 600\text{V}$ , $V_{GE} = 0\text{V}$ , $T_J = 125^\circ\text{C}$ ) <sup>②</sup>			1500	
$I_{GES}$	Gate-Emitter Leakage Current ( $V_{GE} = \pm 20\text{V}$ )			$\pm 100$	nA



**CAUTION:** These Devices are Sensitive to Electrostatic Discharge. Proper Handling Procedures Should Be Followed.

## DYNAMIC CHARACTERISTICS

APT15GT60BR(G)

Symbol	Characteristic	Test Conditions	MIN	TYP	MAX	UNIT
$C_{ies}$	Input Capacitance	<b>Capacitance</b> $V_{GE} = 0V, V_{CE} = 25V$ $f = 1 \text{ MHz}$		830		pF
$C_{oes}$	Output Capacitance			120		
$C_{res}$	Reverse Transfer Capacitance			50		
$V_{GEP}$	Gate-to-Emitter Plateau Voltage	Gate Charge		7.5		V
$Q_g$	Total Gate Charge <sup>③</sup>	$V_{GE} = 15V$		75		nC
$Q_{ge}$	Gate-Emitter Charge	$V_{CE} = 300V$		6		
$Q_{gc}$	Gate-Collector ("Miller") Charge	$I_C = 15A$		34		
SSOA	Switching Safe Operating Area	$T_J = 150^\circ\text{C}, R_G = 10\Omega, V_{GE} = 15V, L = 100\mu\text{H}, V_{CE} = 600V$	45			A
$t_{d(on)}$	Turn-on Delay Time	<b>Inductive Switching (25°C)</b> $V_{CC} = 400V$ $V_{GE} = 15V$ $I_C = 15A$ $R_G = 10\Omega$ $T_J = +25^\circ\text{C}$		6		ns
$t_r$	Current Rise Time			8		
$t_{d(off)}$	Turn-off Delay Time			105		
$t_f$	Current Fall Time			55		μJ
$E_{on1}$	Turn-on Switching Energy <sup>④</sup>			150		
$E_{on2}$	Turn-on Switching Energy (Diode) <sup>⑤</sup>		195			
$E_{off}$	Turn-off Switching Energy <sup>⑥</sup>			215		
$t_{d(on)}$	Turn-on Delay Time	<b>Inductive Switching (125°C)</b> $V_{CC} = 400V$ $V_{GE} = 15V$ $I_C = 15A$ $R_G = 10\Omega$ $T_J = +125^\circ\text{C}$		6		ns
$t_r$	Current Rise Time			8		
$t_{d(off)}$	Turn-off Delay Time			125		
$t_f$	Current Fall Time			100		μJ
$E_{on1}$	Turn-on Switching Energy <sup>④</sup>			150		
$E_{on2}$	Turn-on Switching Energy (Diode) <sup>⑤</sup>			325		
$E_{off}$	Turn-off Switching Energy <sup>⑥</sup>			325		

## THERMAL AND MECHANICAL CHARACTERISTICS

Symbol	Characteristic	MIN	TYP	MAX	UNIT
$R_{\theta JC}$	Junction to Case ( <b>IGBT</b> )			.68	°C/W
$R_{\theta JC}$	Junction to Case ( <b>DIODE</b> )			N/A	
$W_T$	Package Weight		5.9		gm

① Repetitive Rating: Pulse width limited by maximum junction temperature.

② For Combi devices,  $I_{ces}$  includes both IGBT and FRED leakages

③ See MIL-STD-750 Method 3471.

④  $E_{on1}$  is the clamped inductive turn-on energy of the IGBT only, without the effect of a commutating diode reverse recovery current adding to the IGBT turn-on loss. Tested in inductive switching test circuit shown in figure 21, but with a Silicon Carbide diode.

⑤  $E_{on2}$  is the clamped inductive turn-on energy that includes a commutating diode reverse recovery current in the IGBT turn-on switching loss. (See Figures 21, 22.)

⑥  $E_{off}$  is the clamped inductive turn-off energy measured in accordance with JEDEC standard JESD24-1. (See Figures 21, 23.)

APT Reserves the right to change, without notice, the specifications and information contained herein.

# TYPICAL PERFORMANCE CURVES

APT15GT60BR(G)

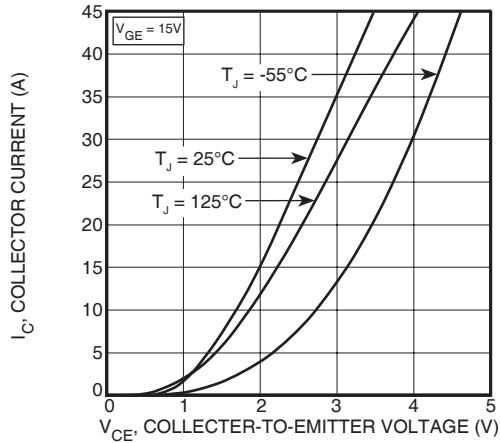

FIGURE 1, Output Characteristics( $T_J = 25^\circ\text{C}$ )

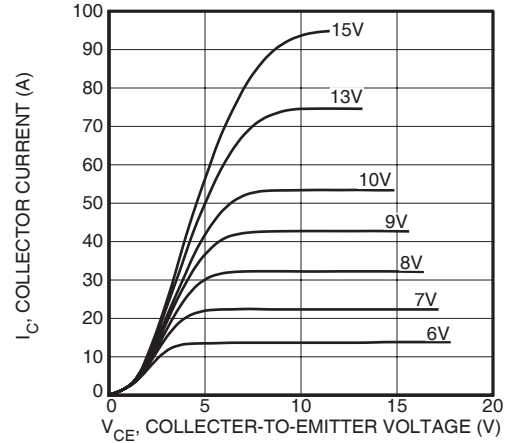

FIGURE 2, Output Characteristics ( $T_J = 125^\circ\text{C}$ )

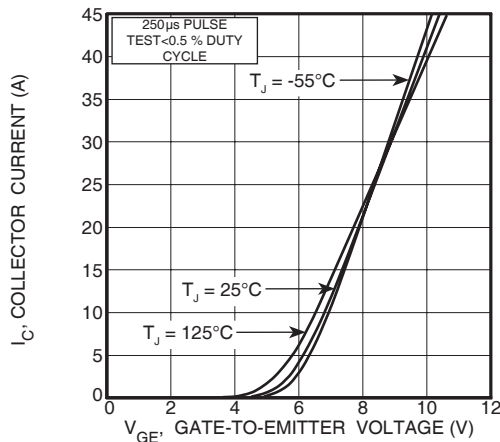

FIGURE 3, Transfer Characteristics

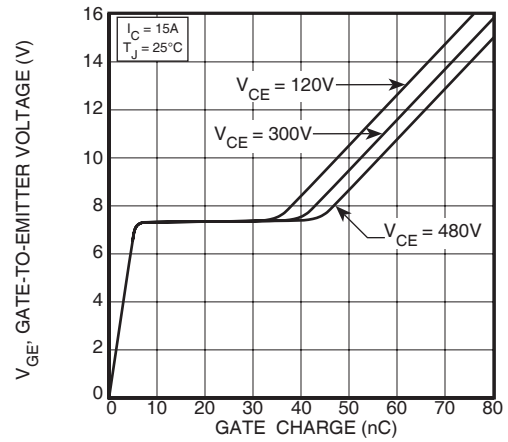

FIGURE 4, Gate Charge

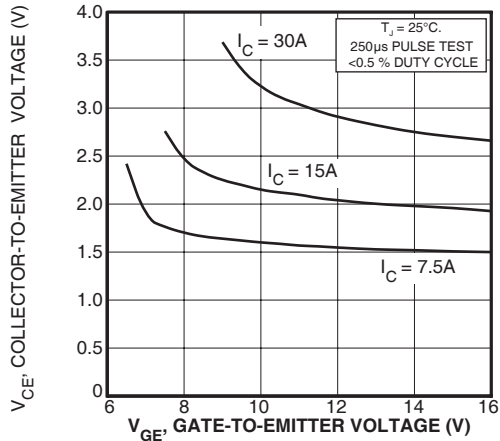

FIGURE 5, On State Voltage vs Gate-to-Emitter Voltage

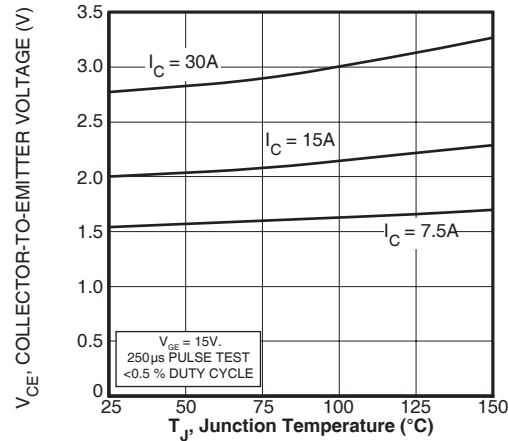

FIGURE 6, On State Voltage vs Junction Temperature

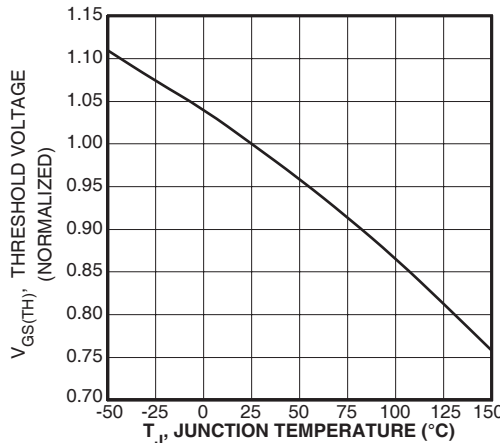

FIGURE 7, Threshold Voltage vs. Junction Temperature

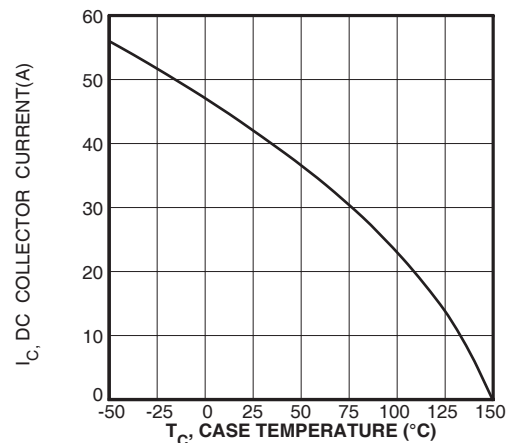

FIGURE 8, DC Collector Current vs Case Temperature

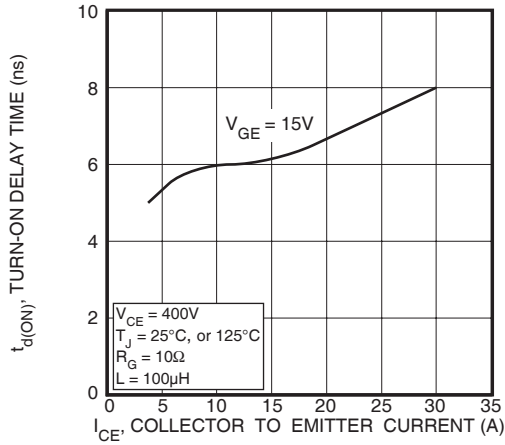

FIGURE 9, Turn-On Delay Time vs Collector Current

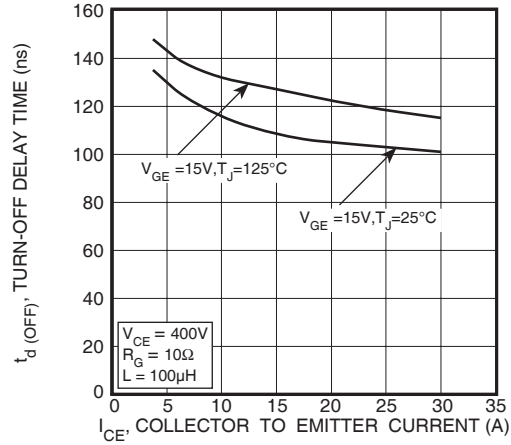

FIGURE 10, Turn-Off Delay Time vs Collector Current

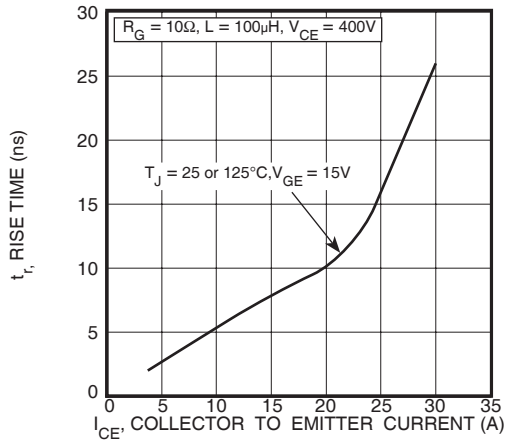

FIGURE 11, Current Rise Time vs Collector Current

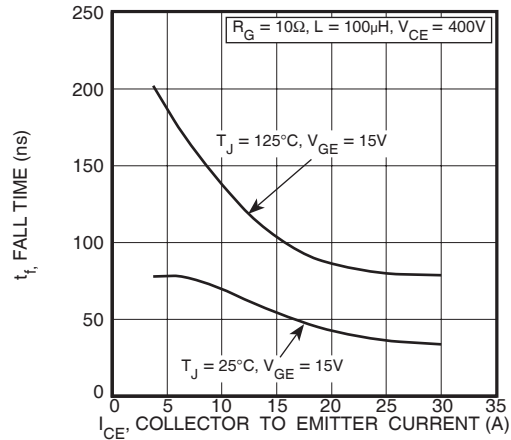

FIGURE 12, Current Fall Time vs Collector Current

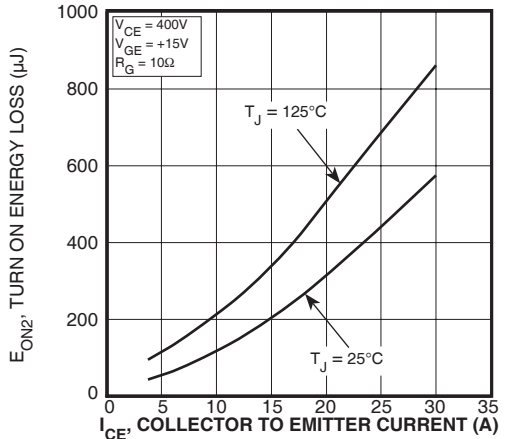

FIGURE 13, Turn-On Energy Loss vs Collector Current

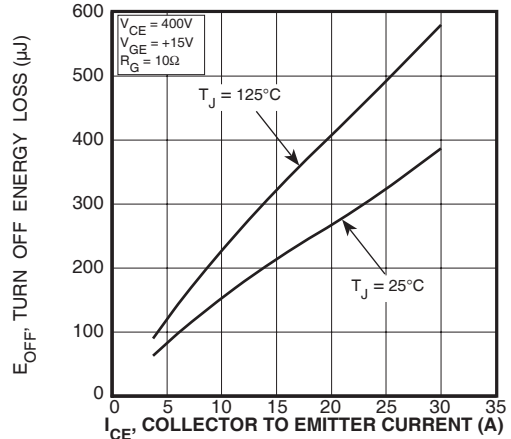

FIGURE 14, Turn Off Energy Loss vs Collector Current

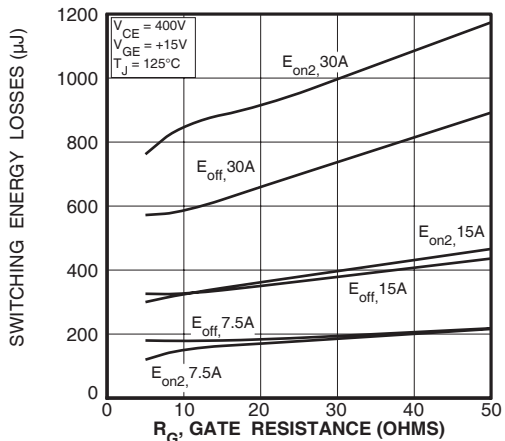

FIGURE 15, Switching Energy Losses vs. Gate Resistance

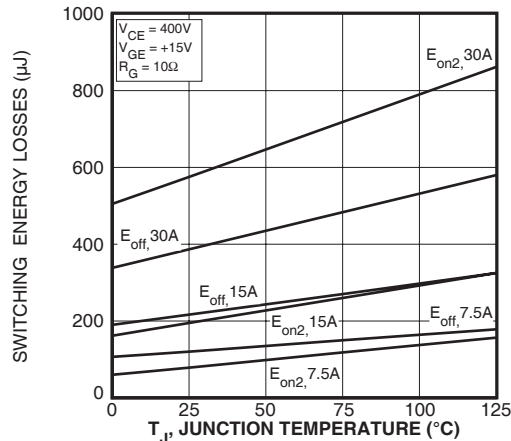

FIGURE 16, Switching Energy Losses vs Junction Temperature

# TYPICAL PERFORMANCE CURVES

APT15GT60BR(G)

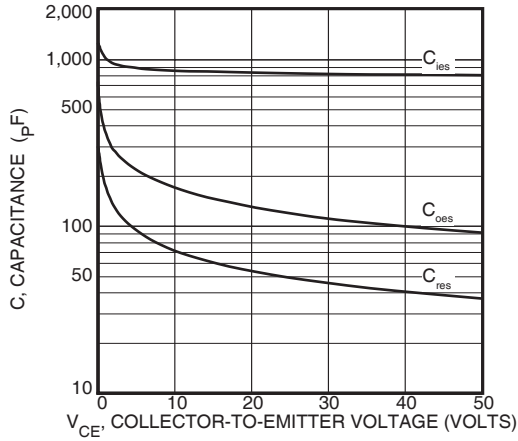

Figure 17, Capacitance vs Collector-To-Emitter Voltage

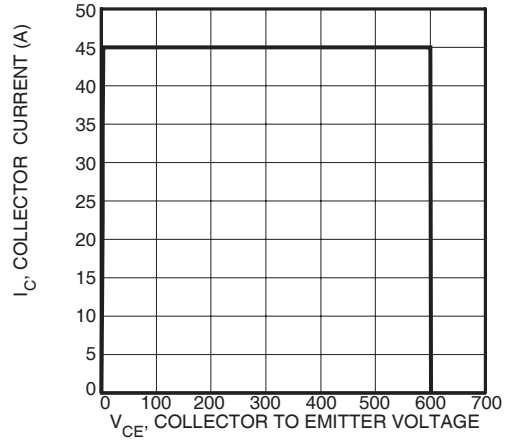

Figure 18, Minimum Switching Safe Operating Area

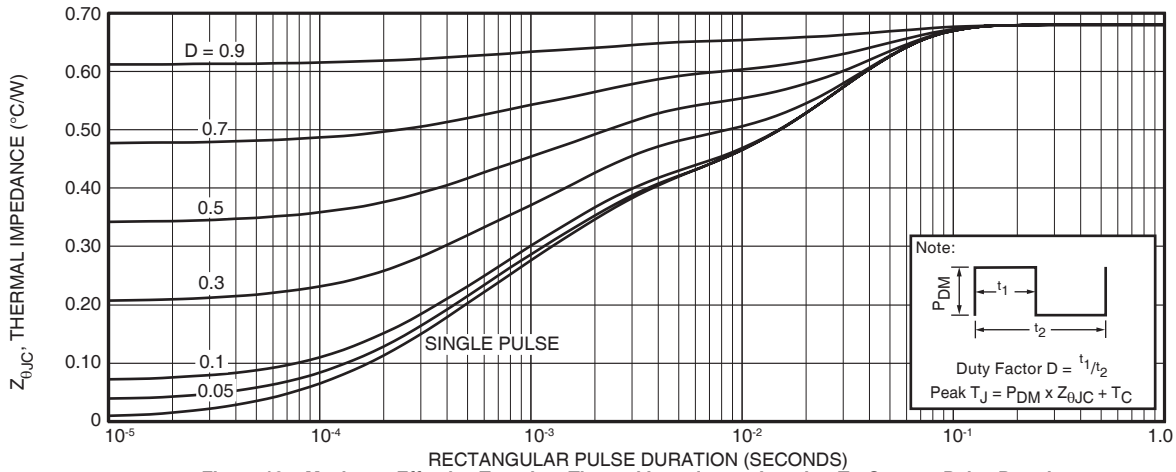

Figure 19a, Maximum Effective Transient Thermal Impedance, Junction-To-Case vs Pulse Duration

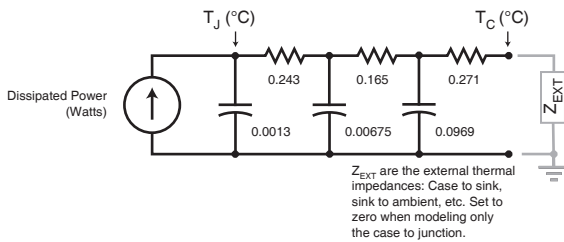

FIGURE 19b, TRANSIENT THERMAL IMPEDANCE MODEL

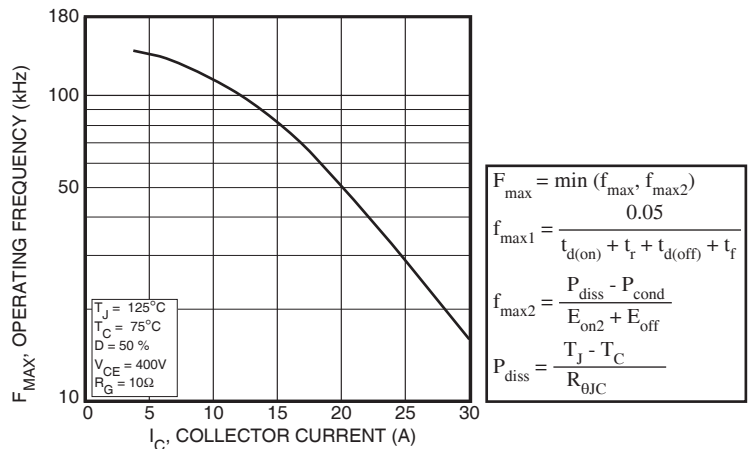

Figure 20, Operating Frequency vs Collector Current

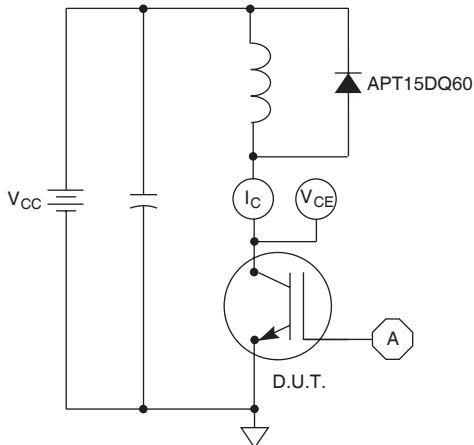

Figure 21, Inductive Switching Test Circuit

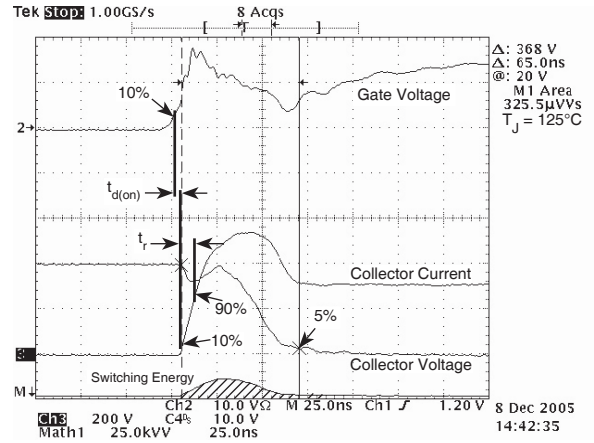

Figure 22, Turn-on Switching Waveforms and Definitions

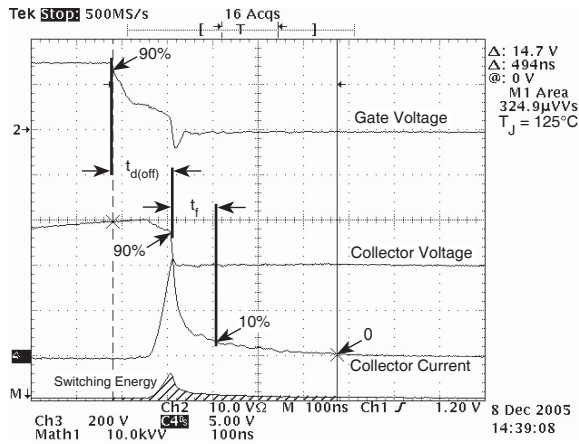
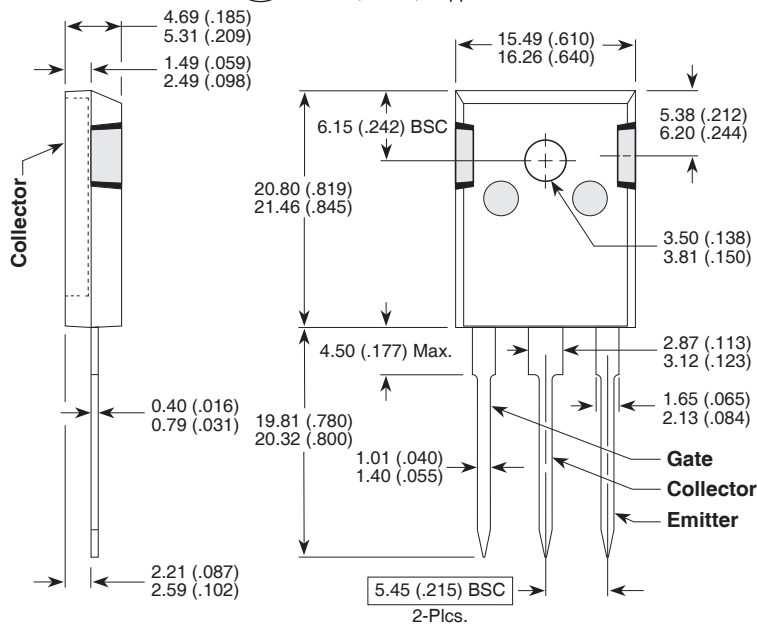

Figure 23, Turn-off Switching Waveforms and Definitions

TO-247 Package Outline

(e1) SAC: Tin, Silver, Copper



Dimensions in Millimeters and (Inches)

APT's products are covered by one or more of U.S. patents 4,895,810 5,045,903 5,089,434 5,182,234 5,019,522 5,262,336 6,503,786 5,256,583 4,748,103 5,283,202 5,231,474 5,434,095 5,528,058 and foreign patents. US and Foreign patents pending. All Rights Reserved.