

J-39-13

MOTOROLA SEMICONDUCTOR TECHNICAL DATA

2N6826

Designer's Data Sheet
Power Field Effect Transistor
N-Channel Enhancement-Mode
Silicon Gate TMOS



TMOS POWER FETs
6 AMPERES
 $r_{DS(on)} = 1.6 \text{ OHM}$
600 VOLTS

These TMOS Power FETs are designed for high voltage, high speed power switching applications such as switching regulators, converters, solenoid and relay drivers.

- Silicon Gate for Fast Switching Speeds — Switching Times Specified at 100°C
- Designer's Data — I_{DSS} , $V_{DS(on)}$, $V_{GS(th)}$ and SOA Specified at Elevated Temperature
- Rugged — SOA is Power Dissipation Limited
- Source-to-Drain Diode Characterized for Use With Inductive Loads

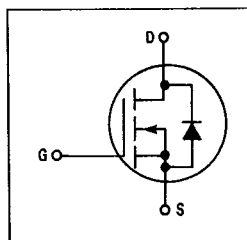

MAXIMUM RATINGS

Rating	Symbol	2N6826	Unit
Drain-Source Voltage	V_{DSS}	600	Vdc
Drain-Gate Voltage ($R_{GS} = 1 \text{ M}\Omega$)	V_{DGR}	600	Vdc
Gate-Source Voltage	V_{GS}	± 20	Vdc
Drain Current			Adc
Continuous @ $T_C = 25^\circ\text{C}$	I_D	6	
Pulsed @ $T_C = 100^\circ\text{C}$	I_{DM}	30	
Total Power Dissipation @ $T_C = 25^\circ\text{C}$ Derate above 25°C	P_D	150	Watts W/°C
Operating Junction Temperature Range	T_J	-65 to 150	°C
Storage Temperature Range	T_{stg}	-65 to 175	°C

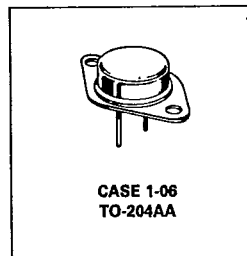

THERMAL CHARACTERISTICS

Thermal Resistance			°C/W
Junction to Case	$R_{\theta JC}$	0.83	
Junction to Ambient	$R_{\theta JA}$	30	
Maximum Lead Temperature for Soldering Purposes, 1/8" from case for 5 seconds	T_L	275	°C

Designer's Data for "Worst Case" Conditions — The Designer's Data Sheet permits the design of most circuits entirely from the information presented. SOA Limit curves — representing boundaries on device characteristics — are given to facilitate "worst case" design.

ELECTRICAL CHARACTERISTICS ($T_C = 25^\circ\text{C}$ unless otherwise noted)

Characteristic	Symbol	Min	Max	Unit
OFF CHARACTERISTICS				
Drain-Source Breakdown Voltage ($V_{GS} = 0, I_D = 0.25 \text{ mA}$)	$V_{(BR)DSS}$	600	—	Vdc
Zero Gate Voltage Drain Current ($V_{DS} = \text{Rated } V_{DSS}, V_{GS} = 0$) ($V_{DS} = 0.8 \text{ Rated } V_{DSS}, V_{GS} = 0, T_J = 125^\circ\text{C}$)	I_{DSS}	—	0.25 2.5	mAdc
Gate-Body Leakage Current, Forward ($V_{GSF} = 20 \text{ Vdc}, V_{DS} = 0$)	I_{GSSF}	—	500	nAdc
Gate-Body Leakage Current, Reverse ($V_{GSR} = 20 \text{ Vdc}, V_{DS} = 0$)	I_{GSSR}	—	500	nAdc

ON CHARACTERISTICS*

Gate Threshold Voltage ($V_{DS} = V_{GS}, I_D = 1 \text{ mA}$) $T_J = 100^\circ\text{C}$	$V_{GS(th)}$	2 1.5	4.5 4	Vdc
Static Drain-Source On-Resistance ($V_{GS} = 10 \text{ Vdc}, I_D = 6 \text{ Adc}$)	$r_{DS(on)}$	—	1.6	Ohm
Drain-Source On-Voltage ($V_{GS} = 10 \text{ V}$) ($I_D = 6 \text{ Adc}$) ($I_D = 4 \text{ Adc}, T_J = 100^\circ\text{C}$)	$V_{DS(on)}$	—	9.6 13.6	Vdc
Forward Transconductance ($V_{DS} = 15 \text{ V}, I_D = 4 \text{ A}$)	g_{FS}	2	10	mhos

DYNAMIC CHARACTERISTICS

Input Capacitance	($V_{DS} = 25 \text{ V}, V_{GS} = 0,$ $f = 1 \text{ MHz}$) See Figure 11	C_{iss}	750	1500	pF
Output Capacitance		C_{oss}	75	400	
Reverse Transfer Capacitance		C_{rss}	25	150	

SWITCHING CHARACTERISTICS* ($T_J = 100^\circ\text{C}$)

Turn-On Delay Time	($V_{DD} = 125 \text{ V}, I_D = 3 \text{ A}$ $R_{gen} = 50 \text{ ohms}$) See Figures 9, 13 and 14	$t_{d(on)}$	—	80	ns
Rise Time		t_r	—	150	
Turn-Off Delay Time		$t_{d(off)}$	—	200	
Fall Time		t_f	—	100	
Total Gate Charge	($V_{DS} = 0.8 \text{ Rated } V_{DSS},$ $I_D = \text{Rated } I_D, V_{GS} = 10 \text{ V}$) See Figure 12	Q_g	55 (Typ)	65	nC
Gate-Source Charge		Q_{gs}	25 (Typ)	—	
Gate-Drain Charge		Q_{gd}	30 (Typ)	—	

SOURCE DRAIN DIODE CHARACTERISTICS*

Forward On-Voltage	($I_S = 6 \text{ A},$ $V_{GS} = 0$)	V_{SD}	0.7	1.4	Vdc
Forward Turn-On Time		t_{on}	Limited by stray inductance		
Reverse Recovery Time		t_{rr}	—	1000	ns

INTERNAL PACKAGE INDUCTANCE

Internal Drain Inductance (Measured from the contact screw on the header closer to the source pin and the center of the die)	L_d	5 (Typ)	—	nH
Internal Source Inductance (Measured from the source pin, 0.25" from the package to the source bond pad)	L_s	12.5 (Typ)	—	

*Pulse Test: Pulse Width $\leq 300 \mu\text{s}$, Duty Cycle $\leq 2\%$.

TYPICAL ELECTRICAL CHARACTERISTICS

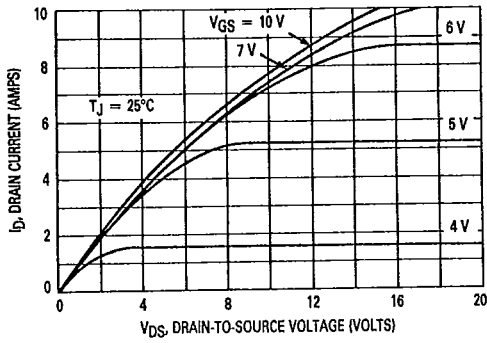

Figure 1. On-Region Characteristics

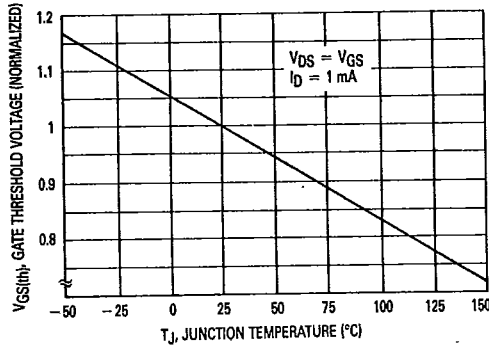

Figure 2. Gate-Threshold Voltage Variation With Temperature

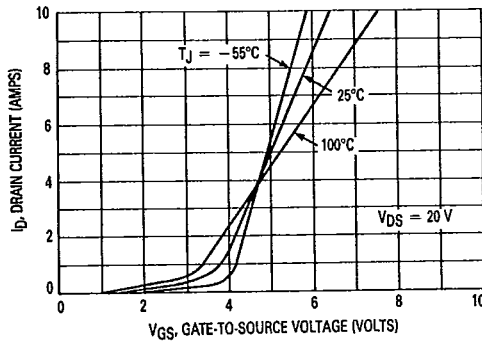

Figure 3. Transfer Characteristics

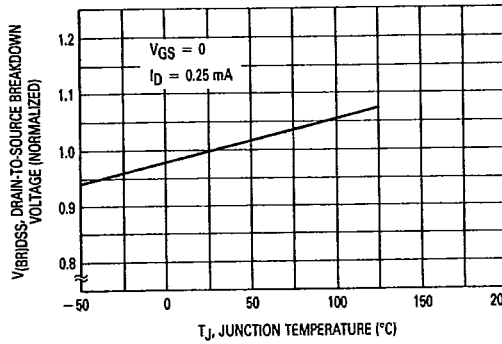

Figure 4. Breakdown Voltage Variation With Temperature

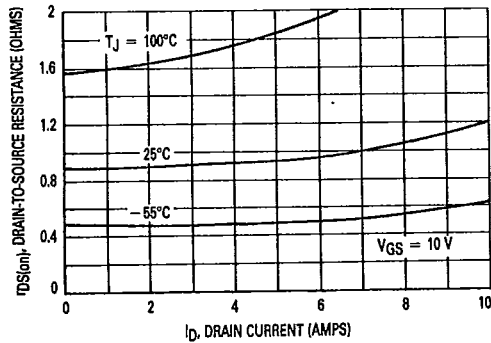

Figure 5. On-Resistance versus Drain Current

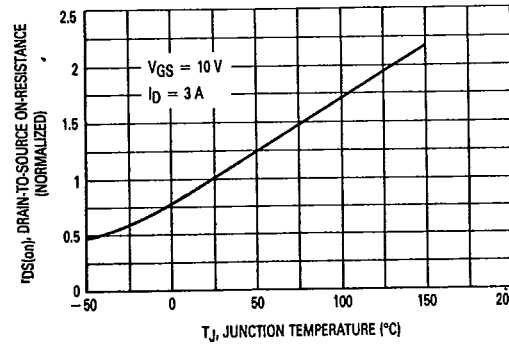

Figure 6. On-Resistance Variation With Temperature

SAFE OPERATING AREA INFORMATION

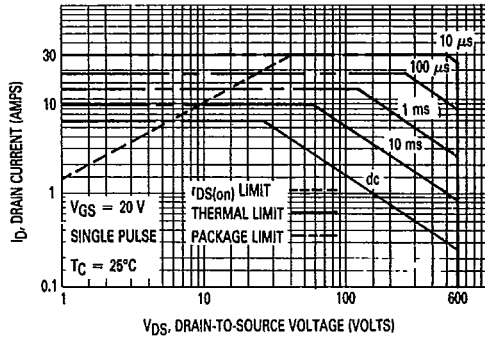

Figure 7. Maximum Rated Forward Biased Safe Operating Area

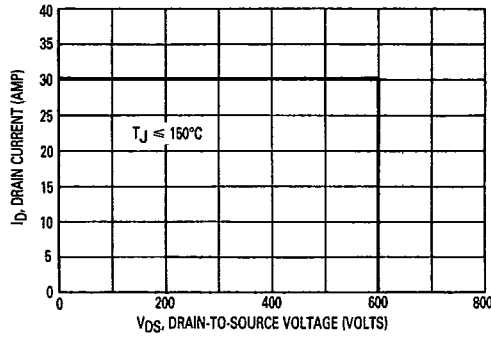

Figure 8. Maximum Rated Switching Safe Operating Area

FORWARD BIASED SAFE OPERATING AREA

The FBSOA curves define the maximum drain-to-source voltage and drain current that a device can safely handle when it is forward biased, or when it is on, or being turned on. Because these curves include the limitations of simultaneous high voltage and high current, up to the rating of the device, they are especially useful to designers of linear systems. The curves are based on a case temperature of 25°C and a maximum junction temperature of 150°C. Limitations for repetitive pulses at various case temperatures can be determined by using the thermal response curves. Motorola Application Note, AN569, "Transient Thermal Resistance-General Data and Its Use" provides detailed instructions.

SWITCHING SAFE OPERATING AREA

The switching safe operating area (SOA) of Figure 8 is the boundary that the load line may traverse without incurring damage to the MOSFET. The fundamental limits are the peak current, I_{DM} and the breakdown voltage, $V(BR)_{DSS}$. The switching SOA shown in Figure 8 is applicable for both turn-on and turn-off of the devices for switching times less than one microsecond.

The power averaged over a complete switching cycle must be less than:

$$\frac{T_J(\max) - T_C}{R_{\theta JC}}$$

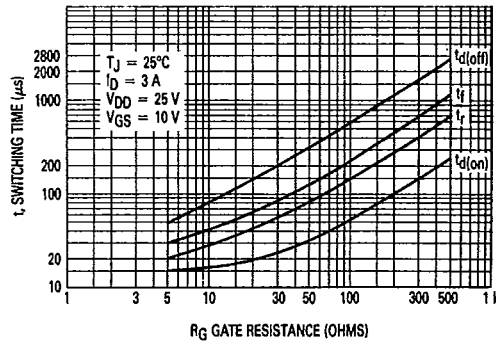

Figure 9. Resistive Switching Time Variation versus Gate Resistance

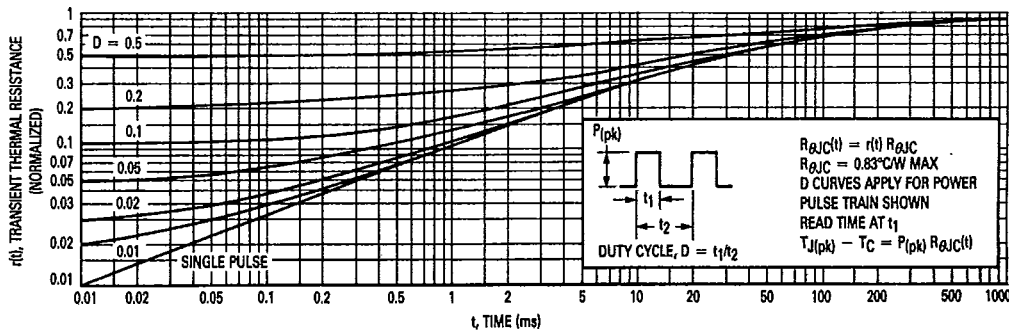

Figure 10. Thermal Response

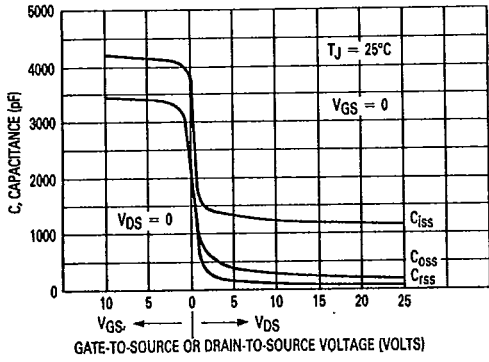

Figure 11. Capacitance Variation

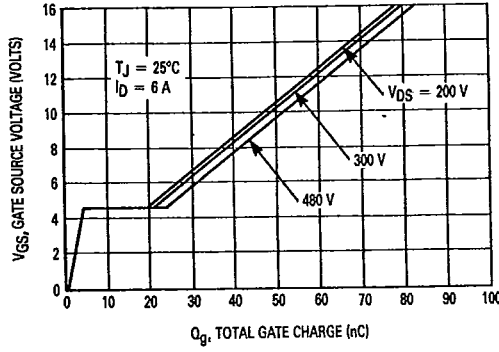

Figure 12. Gate Charge versus Gate-to-Source Voltage

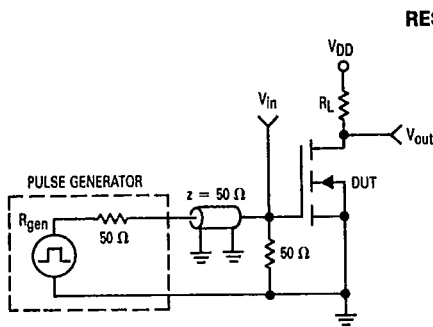

Figure 13. Switching Test Circuit

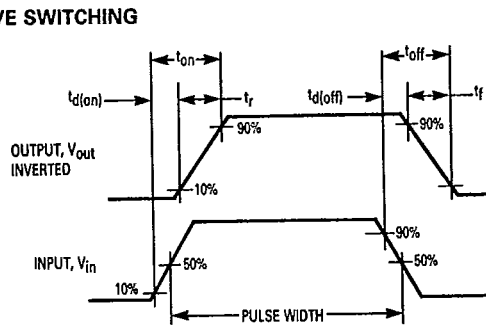

Figure 14. Switching Waveforms

OUTLINE DIMENSIONS

