

**FAIRCHILD**

A Schlumberger Company

**2N6761/2N6762  
N-Channel Power MOSFETs,  
4.5 A, 450 V/500 V**

T-39-11

Power And Discrete Division

**Description**

These devices are n-channel, enhancement mode, power MOSFETs designed especially for high voltage, high speed applications, such as off-line switching power supplies, UPS, AC and DC motor controls, relay and solenoid drivers.

- $V_{GS}$  Rated at  $\pm 20$  V
- Silicon Gate for Fast Switching Speeds
- $I_{DSS}$ ,  $R_{DS(on)}$ , SOA and  $V_{GS(th)}$  Specified at Elevated Temperature
- Rugged

TO-204AA

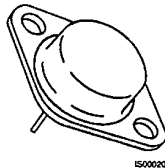

1500020F

2N6761  
2N6762**Maximum Ratings**

Symbol	Characteristic	Rating 2N6762	Rating 2N6761	Unit
$V_{DSS}$	Drain to Source Voltage	500	450	V
$V_{DGR}$	Drain to Gate Voltage $R_{GS} = 1.0 \text{ M}\Omega$	500	450	V
$V_{GS}$	Gate to Source Voltage	$\pm 20$	$\pm 20$	V
$T_J, T_{stg}$	Operating Junction and Storage Temperatures	-55 to +150	-55 to +150	$^{\circ}\text{C}$
$T_L$	Maximum Lead Temperature for Soldering Purposes, 1/16" From Case for 10 s	300	300	$^{\circ}\text{C}$

**Maximum On-State Characteristics**

$R_{DS(on)}$	Static Drain-to-Source On Resistance	1.5	2.0	$\Omega$
$I_D$	Drain Current Continuous at $T_C = 25^{\circ}\text{C}$ Continuous at $T_C = 100^{\circ}\text{C}$	4.5 3.0	4.0 2.5	A
$I_{DM}$	Pulsed	$7.0^2$	$6.0^2$	

**Maximum Thermal Characteristics**

$R_{\theta JC}$	Thermal Resistance, Junction to Case	1.67	1.67	$^{\circ}\text{C}/\text{W}$
$P_D$	Total Power Dissipation at $T_C = 25^{\circ}\text{C}$ at $T_C = 100^{\circ}\text{C}$	75 30	75 30	W
	Linear Derating Factor	0.6	0.6	$\text{W}/^{\circ}\text{C}$

**Notes**

All values are JEDEC registered except as noted. For information concerning connection diagram and package outline, refer to Section 7.

**Electrical Characteristics** ( $T_C = 25^\circ\text{C}$  unless otherwise noted)

Symbol	Characteristic	Min	Max	Unit	Test Conditions
<b>Off Characteristics</b>					
$V_{(BR)DSS}$	Drain Source Breakdown Voltage <sup>1</sup> 2N6762 2N6761			V	$V_{GS} = 0\text{ V}, I_D = 4\text{ mA}$
		500 <sup>2</sup>			
		450 <sup>2</sup>			
$I_{DSS}$	Zero Gate Voltage Drain Current		1	mA	$V_{DS} = \text{Rated } V_{DSS}, V_{GS} = 0\text{ V}$ $V_{DS} = 0.8 \times \text{Rated } V_{DSS}, V_{GS} = 0\text{ V}, T_C = 125^\circ\text{C}$
			4		
$I_{GSS}$	Gate-Body Leakage Current		$\pm 100$	nA	$V_{GS} = \pm 20\text{ V}, V_{DS} = 0\text{ V}$
<b>On Characteristics</b>					
$V_{GS(th)}$	Gate Threshold Voltage	2.0	4.0	V	$I_D = 1.0\text{ mA}, V_{DS} = V_{GS}$
$R_{DS(on)}$	Static Drain-Source On-Resistance <sup>1</sup> 2N6762 2N6761 2N6762 2N6761			$\Omega$	$V_{GS} = 10\text{ V}$ $I_D = 3.0\text{ A}$ $I_D = 2.5\text{ A}$ $I_D = 3.0\text{ A}, T_C = 125^\circ\text{C}$ $I_D = 2.5\text{ A}, T_C = 125^\circ\text{C}$
			1.5		
			2.0		
			3.3		
			4.4		
$V_{DS(on)}$	Drain-Source On-Voltage <sup>1</sup> 2N6762 2N6761		7.7	V	$V_{GS} = 10\text{ V}$ $I_D = 4.5\text{ A}$ $I_D = 4.0\text{ A}$
			8.0		
$g_{fs}$	Forward Transconductance <sup>1</sup>	2.5	7.5	S ( $\Omega$ )	$V_{DS} = 15\text{ V}, I_D = 3.0\text{ A}$
<b>Dynamic Characteristics</b>					
$C_{iss}$	Input Capacitance	350	800	pF	$V_{DS} = 25\text{ V}, V_{GS} = 0\text{ V}$ $f = 1.0\text{ MHz}$
$C_{dss}$	Output Capacitance	25	200	pF	
$C_{res}$	Reverse Transfer Capacitance	15	60	pF	
<b>Switching Characteristics</b> ( $T_C = 25^\circ\text{C}$ , Figures 9, 10)					
$t_{d(on)}$	Turn-On Delay Time		30	ns	$V_{DD} = 225\text{ V}, I_D = 3.0\text{ A}$ $V_{GS} = 10\text{ V}, R_{GEN} = \Omega$ $R_{GS} = 15\ \Omega$
$t_r$	Rise Time		30	ns	
$t_{d(off)}$	Turn-Off Delay Time		55	ns	
$t_f$	Fall Time		30	ns	
$Q_g$	Total Gate Charge		30 <sup>2</sup>	nC	$V_{GS} = 10\text{ V}, I_D = 7.0\text{ A}$ $V_{DD} = 180\text{ V}$

Electrical Characteristics (Cont.) ( $T_C = 25^\circ\text{C}$  unless otherwise noted)

Symbol	Characteristic	Min	Typ	Max	Unit	Test Conditions
<b>Source-Drain Diode Characteristics</b>						
$I_S$	Continuous Source Current 2N6762 2N6761			4.5 4.0	A	
$I_{SM}$	Pulsed Source Current 2N6762 2N6761			7.0 6.0	A	
$V_{SD}$	Diode Forward Voltage 2N6762 2N6761	0.7 0.65		1.4 1.3	V	$V_{GS} = 0\text{ V}$ $I_S = 4.5\text{ A}$ $I_S = 4.0\text{ A}$
$t_{rr}$	Reverse Recovery Time		$520^2$		ns	$V_{GS} = 0\text{ V}$ , $T_J = 150^\circ\text{C}$ $I_F = I_{SM}$ , $dI_F/dt = 100\text{ A}/\mu\text{S}$
$Q_{RR}$	Reverse Recovery Charge		$7.0^2$		$\mu\text{C}$	$V_{GS} = 0\text{ V}$ , $T_J = 150^\circ\text{C}$ $I_F = I_{SM}$ , $dI_F/dt = 100\text{ A}/\mu\text{S}$

Notes

1. Pulse test: Pulse width  $\leq 300\ \mu\text{s}$ , Duty cycle  $\leq 1\%$
2. Non-JEDEC registered value.

Typical Performance Curves

Figure 1 Output Characteristics

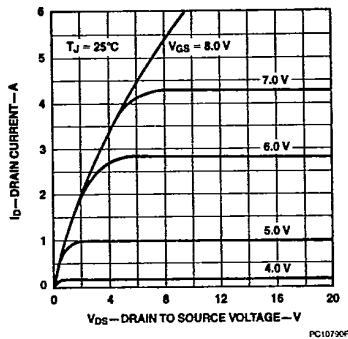
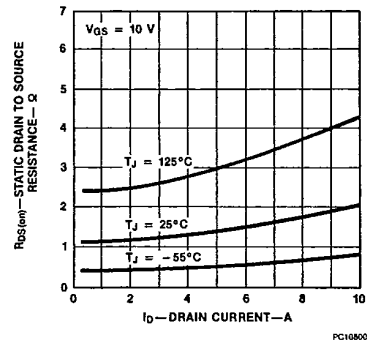

Figure 2 Static Drain to Source Resistance vs Drain Current



2N6761/2N6762

T-39-11

Typical Performance Curves (Cont.)

Figure 3 Transfer Characteristics

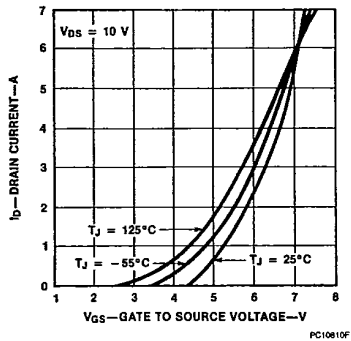

Figure 4 Temperature Variation of Gate to Source Threshold Voltage

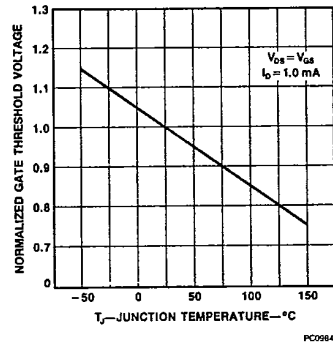

Figure 5 Capacitance vs Drain to Source Voltage

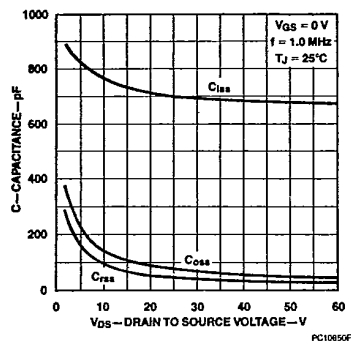

Figure 6 Gate to Source Voltage vs Total Gate Charge

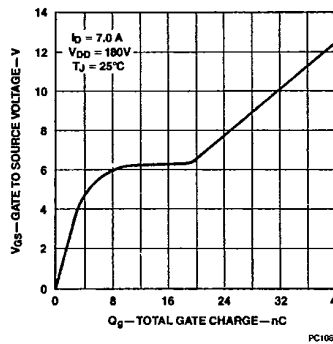

Figure 7 Forward Biased Safe Operating Area

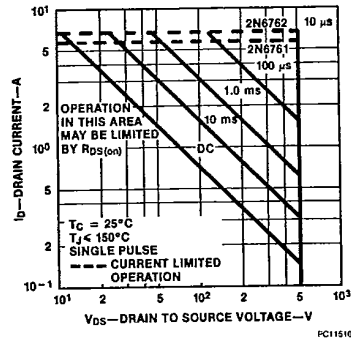
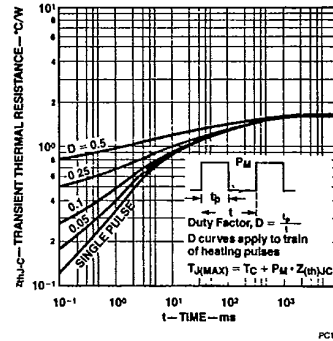
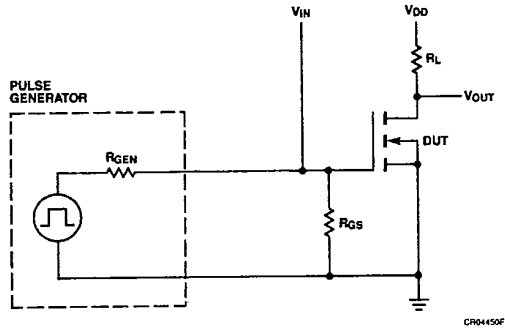

Figure 8 Transient Thermal Resistance vs Time



Typical Electrical Characteristics

Figure 9 Switching Test Circuit



CR04450F

Figure 10 Switching Waveforms

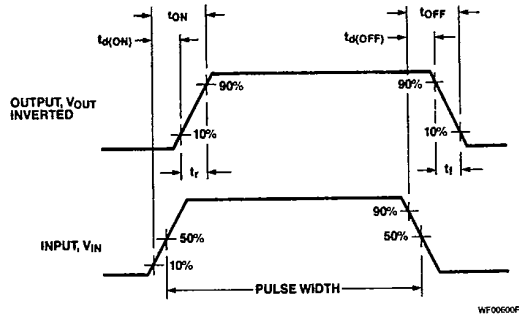

WF00000F