

Notice: You cannot copy or search for text in this PDF file, because this PDF file is converted from the scanned image of printed materials.

P1 98.2

MOS FIELD EFFECT POWER TRANSISTOR 2SK1988, 1989

SWITCHING N-CHANNEL POWER MOS FET INDUSTRIAL USE

DESCRIPTION

The 2SK1988, 1989 is N-channel MOS Field Effect Transistor designed for high voltage switching applications.

FEATURES

- Low On-state Resistance
 2SK1988 $R_{DS(on)} = 2.8 \Omega \text{ MAX. (} V_{GS} = 10 \text{ V, } I_D = 1.5 \text{ A)}$
 2SK1989 $R_{DS(on)} = 3.0 \Omega \text{ MAX. (} V_{GS} = 10 \text{ V, } I_D = 1.5 \text{ A)}$
- Low C_{iss} $C_{iss} = 350 \text{ pF TYP.}$
- Built-in G-S Gate Protection Diode
- High Avalanche Capability Ratings

QUALITY GRADE

Standard

Please refer to "Quality grade on NEC Semiconductor Devices" (Document number IEI-1209) published by NEC Corporation to know the specification of quality grade on the devices and its recommended applications.

ABSOLUTE MAXIMUM RATINGS ($T_a = 25^\circ\text{C}$)

Drain to Source Voltage	V_{DSS}	450/500	V
Gate to Source Voltage	V_{GSS}	± 30	V
Drain Current (DC)	$I_{D(DC)}$	± 2.5	A
Drain Current (pulse)	$I_{D(pulse)^*}$	± 10	A
Single Avalanche Current	I_{AS}	3.75	A
Single Avalanche Energy	E_{AS}	73.8	mJ
Total Power Dissipation ($T_c = 25^\circ\text{C}$)	P_{T1}	30	W
Total Power Dissipation ($T_a = 25^\circ\text{C}$)	P_{T2}	2.0	W
Channel Temperature	T_{ch}	150	$^\circ\text{C}$
Storage Temperature	T_{stg}	-55 to +150	$^\circ\text{C}$

* $PW \leq 10 \mu\text{s}$, Duty Cycle $\leq 1\%$

** Starting $T_{ch} = 25^\circ\text{C}$, $R_G = 25 \Omega$, $V_{GS} = 20 \text{ V} \rightarrow 0$

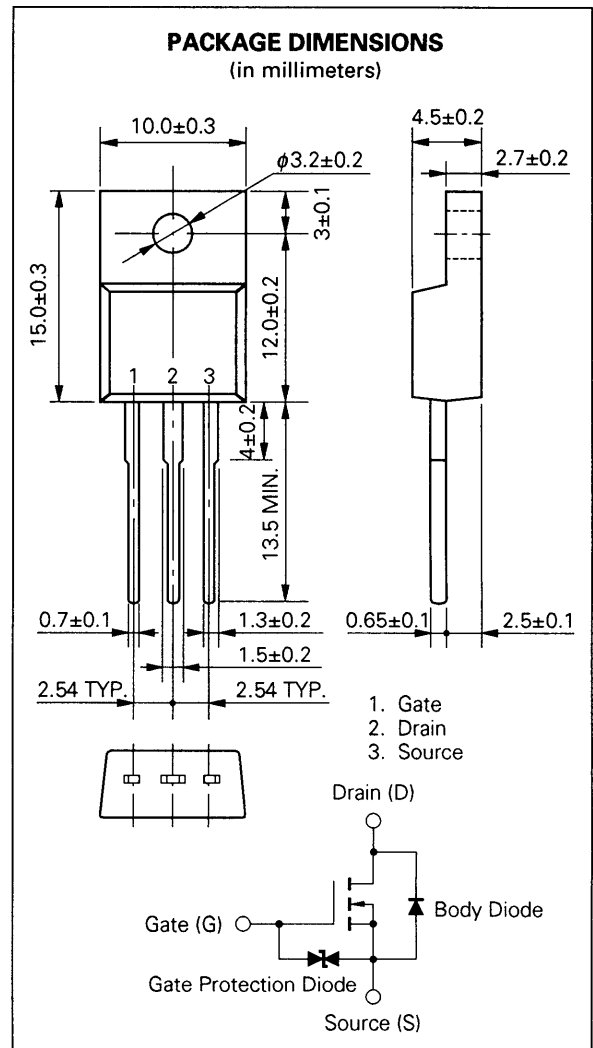

ELECTRICAL CHARACTERISTICS (T_a = 25 °C)

CHARACTERISTIC	SYMBOL	MIN.	TYP.	MAX.	UNIT	TEST CONDITIONS
Drain to Source On-state Resistance (2SK1988)	R _{DS(on)}		2.2	2.8	Ω	V _{GS} = 10 V, I _D = 1.5 A
Drain to Source On-state Resistance (2SK1989)	R _{DS(on)}		2.4	3.0	Ω	V _{GS} = 10 V, I _D = 1.5 A
Gate to Source Cutoff Voltage	V _{GS(off)}	2.5		3.5	V	V _{DS} = 10 V, I _D = 1 mA
Forward Transfer Admittance	y _{fs}	0.9			S	V _{DS} = 10 V, I _D = 1.5 A
Drain Leakage Current	I _{DSS}			100	μA	V _{DS} = 450/500 V, V _{GS} = 0
Gate to Source Leakage Current	I _{GSS}			±10	μA	V _{GS} = ±30 V, V _{DS} = 0
Input Capacitance	C _{iss}		350		pF	V _{DS} = 10 V V _{GS} = 0 f = 1 MHz
Output Capacitance	C _{oss}		120		pF	
Reverse Transfer Capacitance	C _{rss}		45		pF	
Turn-On Delay Time	t _{d(on)}		10		ns	V _{GS} = 10 V V _{DD} = 150 V I _D = 1.5 A, R _G = 10 Ω R _L = 100 Ω
Rise Time	t _r		10		ns	
Turn-Off Delay Time	t _{d(off)}		30		ns	
Fall Time	t _f		10		ns	
Total Gate Charge	Q _G		12		nC	V _{GS} = 10 V I _D = 2.5 A V _{DD} = 400 V
Gate to Source Charge	Q _{GS}		3.0		nC	
Gate to Drain Charge	Q _{GD}		7.0		nC	
Diode Forward Voltage	V _{F(S-D)}		0.9		V	I _F = 2.5 A, V _{GS} = 0
Reverse Recovery Time	t _{rr}		310		ns	I _F = 2.5 A
Reverse Recovery Charge	Q _{rr}		1.2		μC	di/dt = 50 A/μs

Test Circuit 1: Avalanche Capability

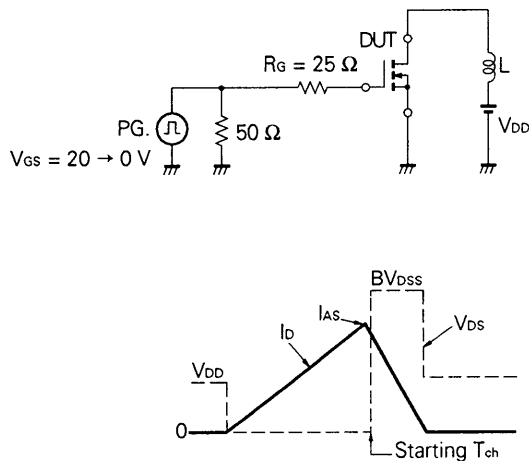

Test Circuit 2: Switching Time

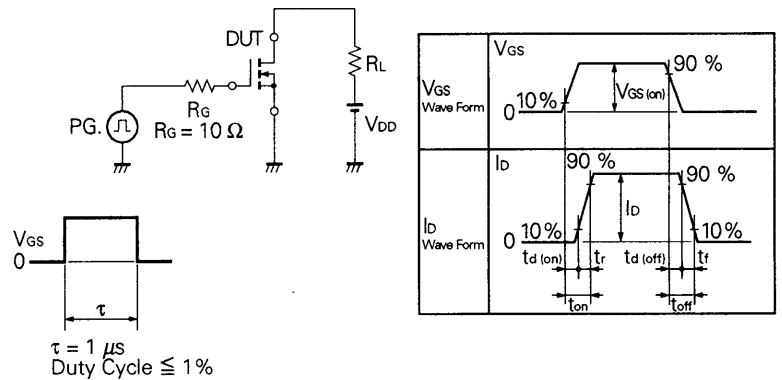

Test Circuit 3: Gate Charge

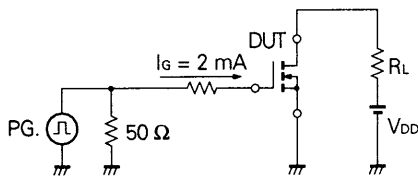

TYPICAL CHARACTERISTICS ($T_a = 25^\circ\text{C}$)

DERATING FACTOR OF FORWARD BIAS SAFE OPERATING AREA

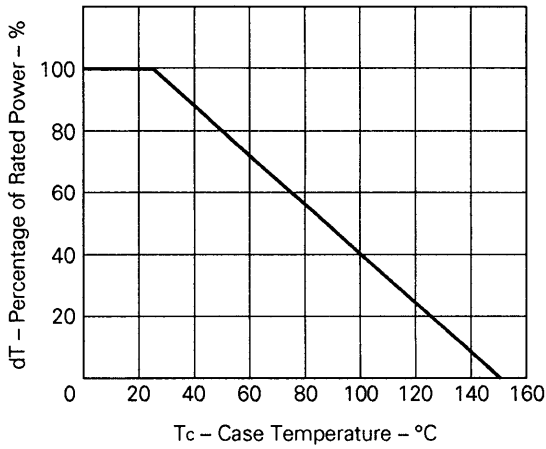

TOTAL POWER DISSIPATION vs. CASE TEMPERATURE

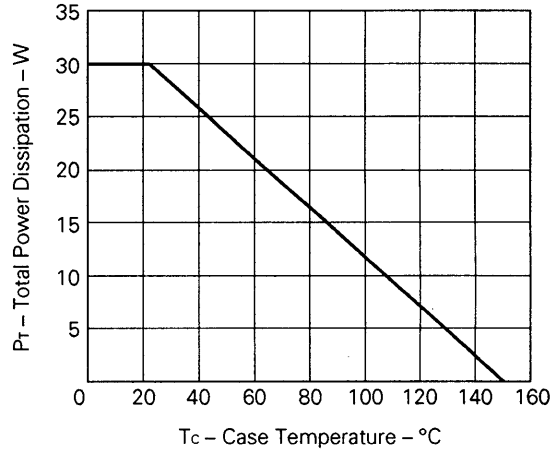

FORWARD BIAS SAFE OPERATING AREA

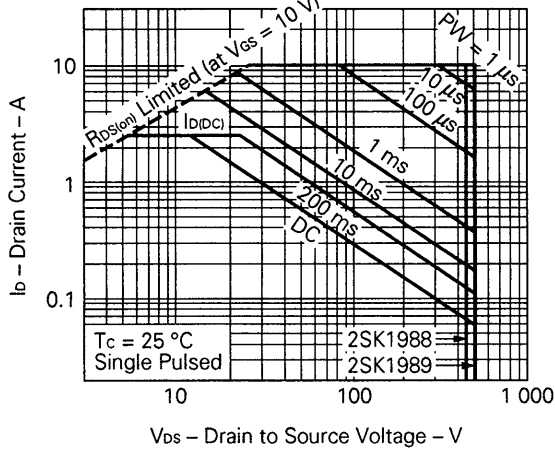

DRAIN CURRENT vs. DRAIN TO SOURCE VOLTAGE

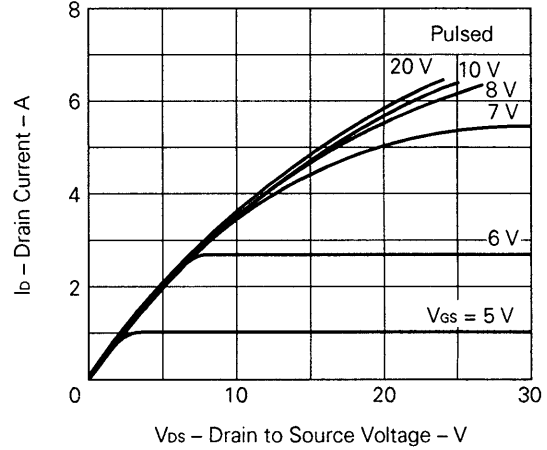

TRANSFER CHARACTERISTICS

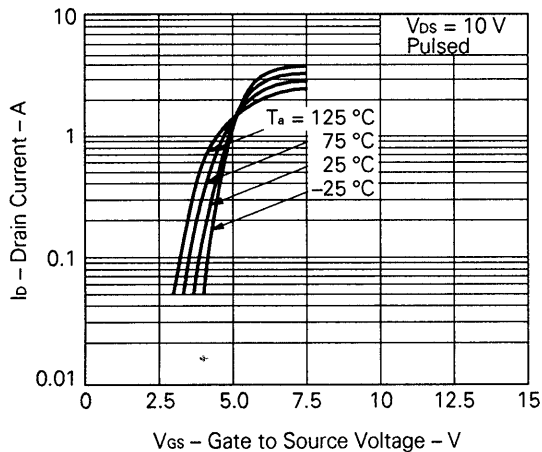

TRANSIENT THERMAL RESISTANCE vs. PULSE WIDTH

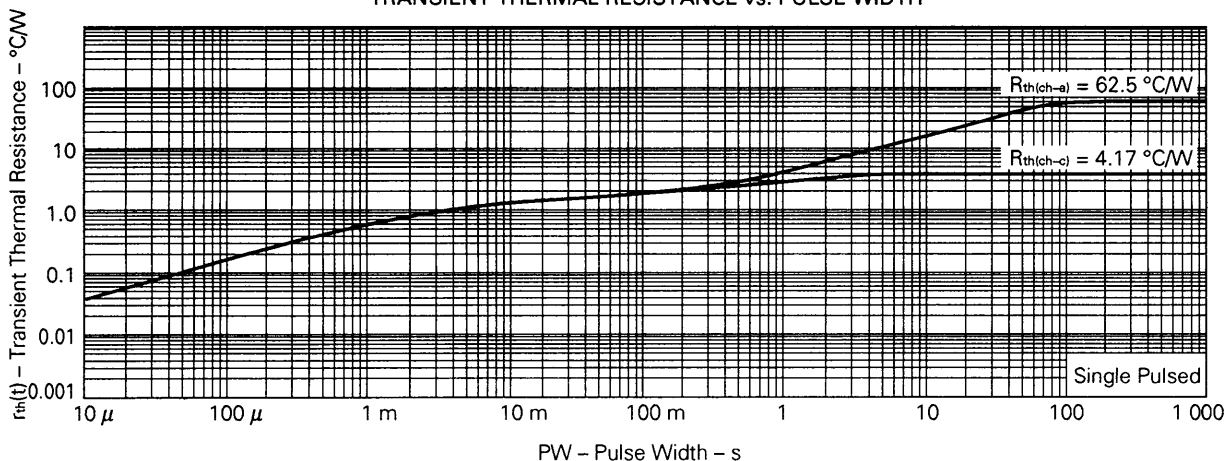

FORWARD TRANSFER ADMITTANCE vs. DRAIN CURRENT

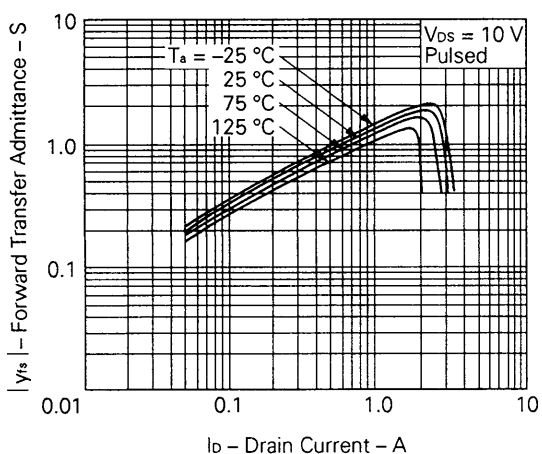

DRAIN TO SOURCE ON-STATE RESISTANCE vs. GATE TO SOURCE VOLTAGE

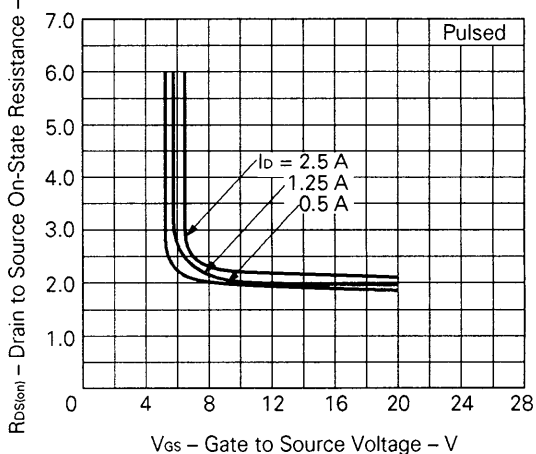

DRAIN TO SOURCE ON-STATE RESISTANCE vs. DRAIN CURRENT

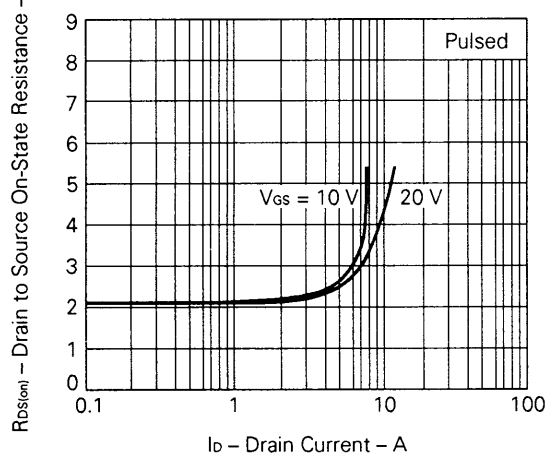

GATE TO SOURCE CUTOFF VOLTAGE vs. CHANNEL TEMPERATURE

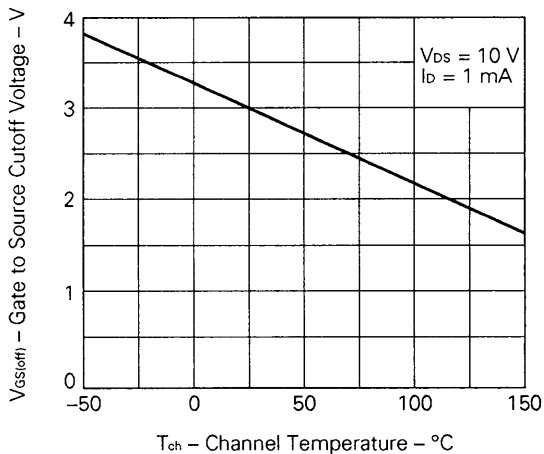

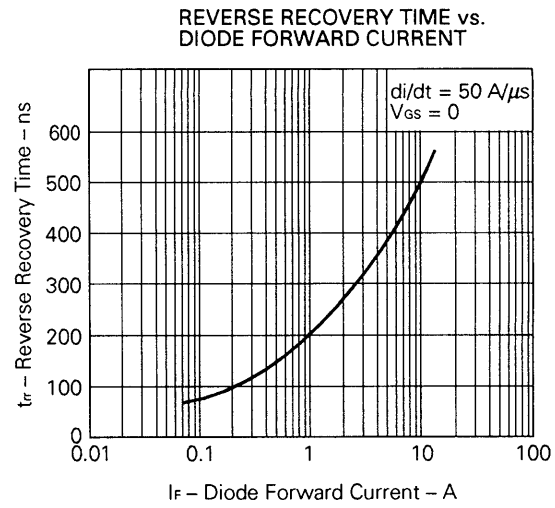
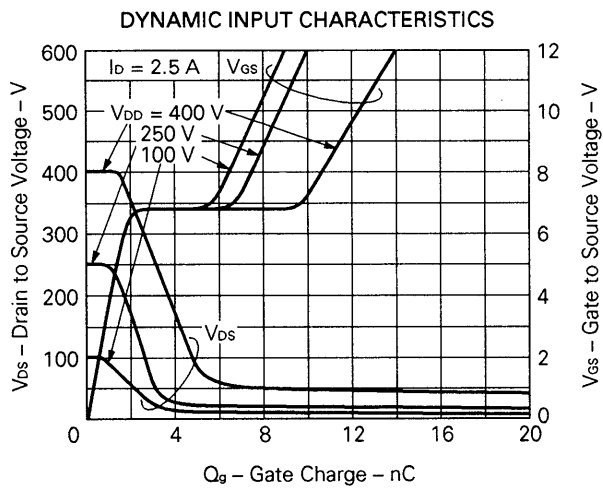
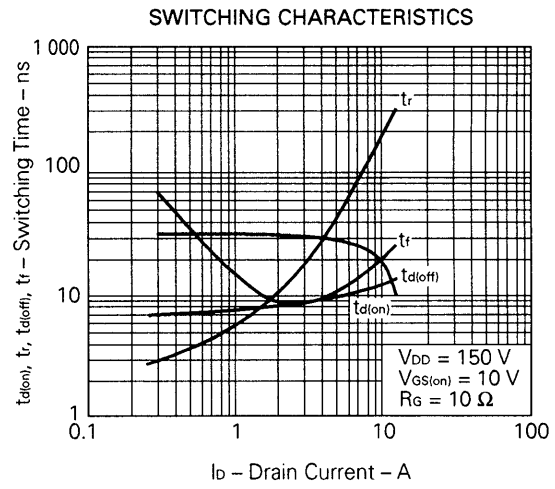
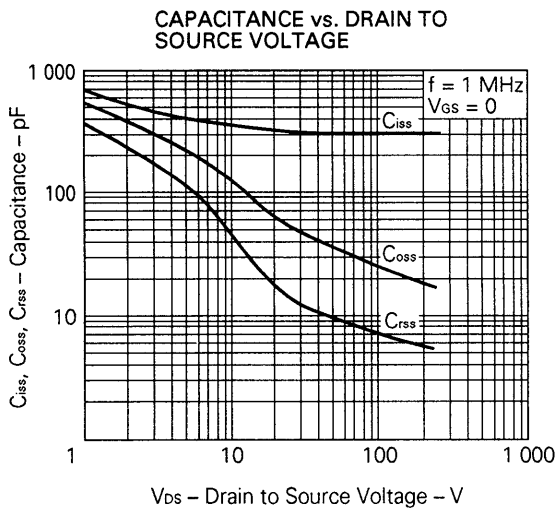
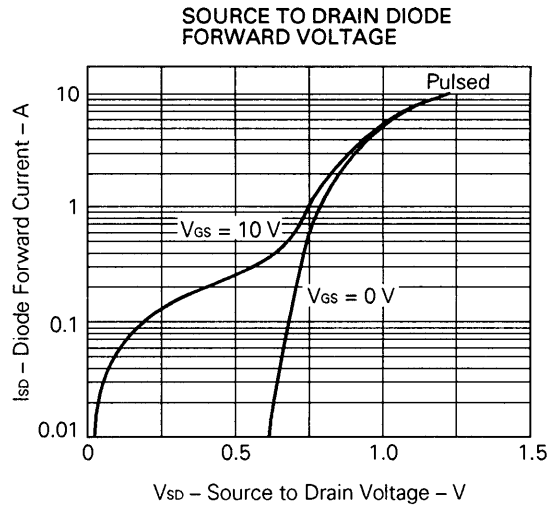
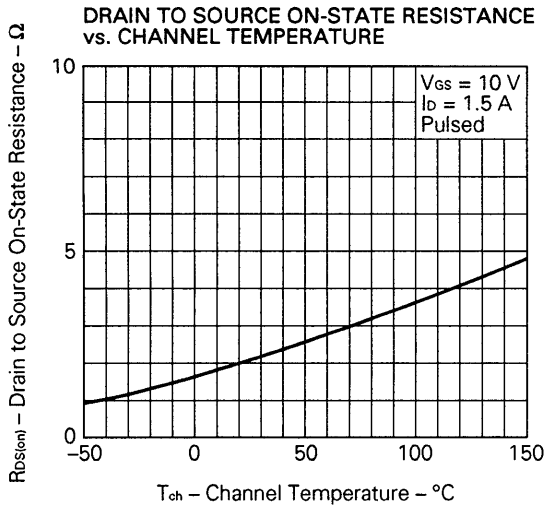

SINGLE AVALANCHE CURRENT vs. INDUCTIVE LOAD

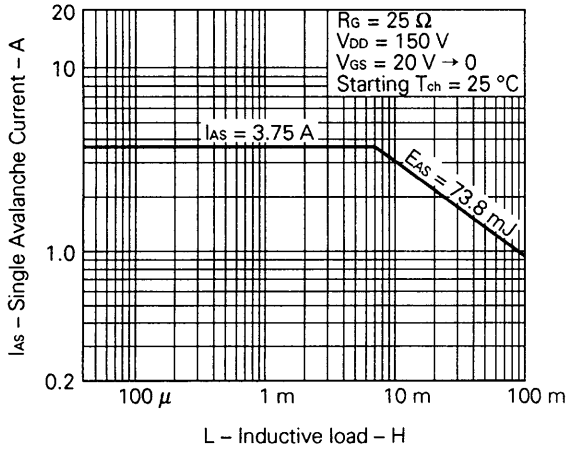

SINGLE AVALANCHE ENERGY vs. STARTING CHANNEL TEMPERATURE

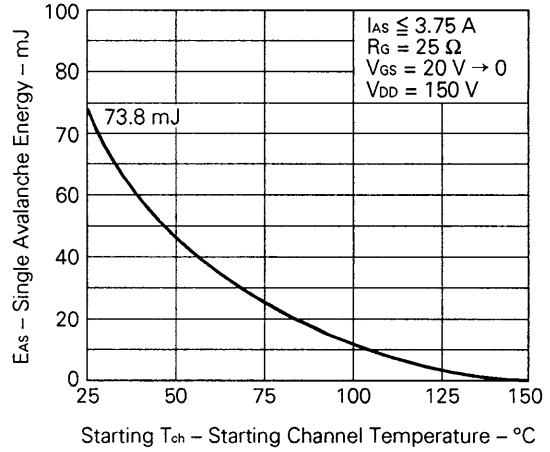

Reference

Application note name	No.
Safe operating area of Power MOS FET.	TEA-1034
Application circuit using Power MOS FET.	TEA-1035
Quality control of NEC semiconductors devices.	TEI-1202
Quality control guide of semiconductors devices.	MEI-1202
Assembly manual of semiconductors devices.	IEI-1207

[MEMO]

No part of this document may be copied or reproduced in any form or by any means without the prior written consent of NEC Corporation. NEC Corporation assumes no responsibility for any errors which may appear in this document.

NEC Corporation does not assume any liability for infringement of patents, copyrights or other intellectual property rights of third parties by or arising from use of a device described herein or any other liability arising from use of such device. No license, either express, implied or otherwise, is granted under any patents, copyrights or other intellectual property rights of NEC Corporation or others.

The devices listed in this document are not suitable for use in aerospace equipment, submarine cables, nuclear reactor control systems and life support systems. If customers intend to use NEC devices for above applications or they intend to use "Standard" quality grade NEC devices for applications not intended by NEC, please contact our sales people in advance.

Application examples recommended by NEC Corporation.

Standard: Computer, Office equipment, Communication equipment, Test and Measurement equipment, Machine tools, Industrial robots, Audio and Visual equipment, Other consumer products, etc.

Special: Automotive and Transportation equipment, Traffic control systems, Antidisaster systems, Anticrime systems, etc.