

Power MOSFET

PRODUCT SUMMARY		
V_{DS} (V)	- 50	
$R_{DS(on)}$ (Ω)	$V_{GS} = - 10$ V	0.50
Q_g (Max.) (nC)	11	
Q_{gs} (nC)	3.8	
Q_{gd} (nC)	4.1	
Configuration	Single	

FEATURES

- For Automatic Insertion
- Compact, End Stackable
- Fast Switching
- Low Drive Current
- Easy Paralleled
- Excellent Temperature Stability
- P-Channel Versatility
- Compliant to RoHS Directive 2002/95/EC



 Available
RoHS*
 COMPLIANT

DESCRIPTION

The HVMDIP technology is the key to Vishay's advanced line of power MOSFET transistors. The efficient geometry and unique processing of the HVMDIP design achieves very low on-state resistance combined with high transconductance and extreme device ruggedness.

The p-channel HVMDIPs are designed for application which require the convenience of reverse polarity operation. They retain all of the features of the more common n-channel HVMDIPs such as voltage control, very fast switching, ease of paralleling, and excellent temperature stability.

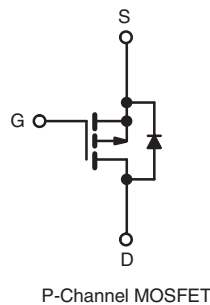
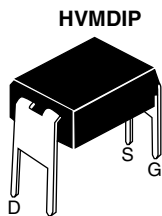
P-channels HVMDIPs are intended for use in power stages where complementary symmetry with n-channel devices offers circuit simplification. They are also very useful in drive stages because of the circuit versatility offered by the reverse polarity connection. Applications include motor control, audio amplifiers, switched mode converters, control circuits and pulse amplifiers.



ORDERING INFORMATION	
Package	HVMDIP
Lead (Pb)-free	IRFD9010PbF
	SiHFD9010-E3
SnPb	IRFD9010
	SiHFD9010



ABSOLUTE MAXIMUM RATINGS ($T_C = 25$ °C, unless otherwise noted)					
PARAMETER		SYMBOL	LIMIT	UNIT	
Drain-Source Voltage		V_{DS}	- 50	V	
Gate-Source Voltage		V_{GS}	± 20		
Continuous Drain Current	V_{GS} at - 10 V	I_D	$T_C = 25$ °C	- 1.1	A
			$T_C = 100$ °C	- 0.68	
Pulsed Drain Current ^a		I_{DM}	- 8.8		
Linear Derating Factor			0.01	W/°C	
Inductive Current, Clamped	L = 100 μ H see fig. 14	I_{LM}	- 8.8	A	
Inductive Current, Unclamped (Avalanche Current)	see fig. 15	I_L	- 1.5		
Maximum Power Dissipation	$T_C = 25$ °C	P_D	1	W	
Operating Junction and Storage Temperature Range		T_J, T_{stg}	- 55 to + 150	°C	
Soldering Recommendations (Peak Temperature)	for 10 s		300 ^d		

Notes

- Repetitive rating; pulse width limited by maximum junction temperature (see fig. 11).
- $V_{DD} = - 25$ V, starting $T_J = 25$ °C, L = 52 mH, $R_g = 25$ Ω , $I_{AS} = - 2.0$ A (see fig. 12).
- $I_{SD} \leq - 4.0$ A, $dI/dt \leq 75$ A/ μ s, $V_{DD} \leq V_{DS}$, $T_J \leq 175$ °C.
- 1.6 mm from case.

* Pb containing terminations are not RoHS compliant, exemptions may apply

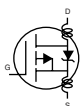
THERMAL RESISTANCE RATINGS				
PARAMETER	SYMBOL	TYP.	MAX.	UNIT
Maximum Junction-to-Ambient	R_{thJA}	-	120	$^{\circ}\text{C}/\text{W}$

SPECIFICATIONS ($T_J = 25^{\circ}\text{C}$, unless otherwise noted)						
PARAMETER	SYMBOL	TEST CONDITIONS	MIN.	TYP.	MAX.	UNIT
Static						
Drain-Source Breakdown Voltage	V_{DS}	$V_{GS} = 0\text{ V}, I_D = -250\ \mu\text{A}$	- 50	-	-	V
V_{DS} Temperature Coefficient	$\Delta V_{DS}/T_J$	Reference to 25°C , $I_D = -1\ \text{mA}$	-	- 0.091	-	$\text{V}/^{\circ}\text{C}$
Gate-Source Threshold Voltage	$V_{GS(th)}$	$V_{DS} = V_{GS}, I_D = -250\ \mu\text{A}$	- 2.0	-	- 4.0	V
Gate-Source Leakage	I_{GSS}	$V_{GS} = \pm 20\ \text{V}$	-	-	± 500	nA
Zero Gate Voltage Drain Current	I_{DSS}	$V_{DS} = -50\ \text{V}, V_{GS} = 0\ \text{V}$	-	-	- 250	μA
		$V_{DS} = -40\ \text{V}, V_{GS} = 0\ \text{V}, T_J = 125^{\circ}\text{C}$	-	-	- 1000	
On-State Drain Current	$I_{D(on)}$	$V_{GS} = 10\ \text{V}$ $V_{DS} > I_{D(on)} \times R_{DS(on)}$ max.	- 1.1	-	-	A
Drain-Source On-State Resistance	$R_{DS(on)}$	$V_{GS} = -10\ \text{V}$ $I_D = -0.58\ \text{A}^b$	-	0.35	0.50	Ω
Forward Transconductance	g_{fs}	$V_{DS} = -20\ \text{V}, I_D = -2.4\ \text{A}$	1.7	2.5	-	S
Dynamic						
Input Capacitance	C_{iss}	$V_{GS} = 0\ \text{V},$ $V_{DS} = -25\ \text{V},$ $f = 1.0\ \text{MHz}$, see fig. 5	-	240	-	pF
Output Capacitance	C_{oss}		-	160	-	
Reverse Transfer Capacitance	C_{rss}		-	30	-	
Total Gate Charge	Q_g	$V_{GS} = -10\ \text{V}$ $I_D = -4.7\ \text{A}, V_{DS} = 0.8\ \text{V}$ see fig. 6 and 13 ^b	-	7.2	11	nC
Gate-Source Charge	Q_{GS}		-	2.5	3.8	
Gate-Drain Charge	Q_{GD}		-	2.7	4.1	
Turn-On Delay Time	$t_{d(on)}$	$V_{DD} = -25\ \text{V}, I_D = -4.7\ \text{A}$ $R_g = 24\ \Omega, R_D = 5.6\ \Omega,$ see fig. 10 ^b	-	6.1	9.2	ns
Rise Time	t_r		-	47	71	
Turn-Off Delay Time	$t_{d(off)}$		-	13	20	
Fall Time	t_f		-	39	59	
Internal Drain Inductance	L_D	Between lead, 6 mm (0.25") from package and center of die contact 	-	4.0	-	nH
Internal Source Inductance	L_S		-	6.0	-	
Drain-Source Body Diode Characteristics						
Continuous Source-Drain Diode Current	I_S	MOSFET symbol showing the integral reverse p - n junction diode 	-	-	- 1.1	A
Pulsed Diode Forward Current ^a	I_{SM}		-	-	- 8.8	
Body Diode Voltage	V_{SD}	$T_J = 25^{\circ}\text{C}, I_S = -0.7\ \text{A}, V_{GS} = 0\ \text{V}^b$	-	-	- 5.5	V
Body Diode Reverse Recovery Time	t_{rr}	$T_J = 25^{\circ}\text{C}, I_F = -4.7\ \text{A}, dI/dt = 100\ \text{A}/\mu\text{s}^b$	33	75	160	ns
Body Diode Reverse Recovery Charge	Q_{rr}		0.090	0.22	0.52	μC
Forward Turn-On Time	t_{on}	Intrinsic turn-on time is negligible (turn-on is dominated by L_S and L_D)				

Notes

- a. Repetitive rating; pulse width limited by maximum junction temperature (see fig. 11).
- b. Pulse width $\leq 300\ \mu\text{s}$; duty cycle $\leq 2\ \%$.

TYPICAL CHARACTERISTICS (25 °C, unless otherwise noted)

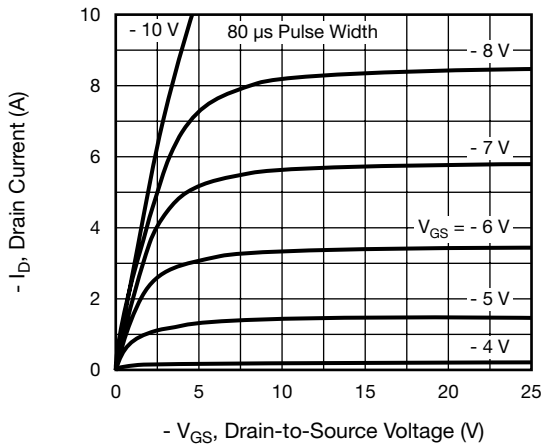

Fig. 1 - Typical Output Characteristics

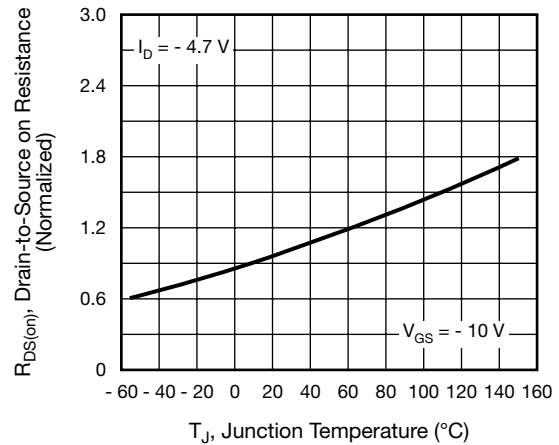

Fig. 4 - Normalized On-Resistance vs. Temperature

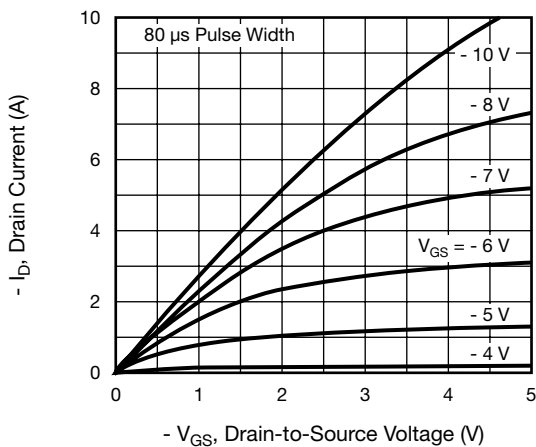

Fig. 2 - Typical Output Characteristics

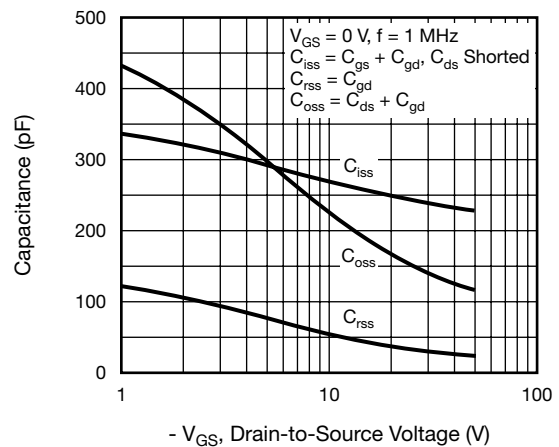

Fig. 5 - Typical Capacitance vs. Drain-to-Source Voltage

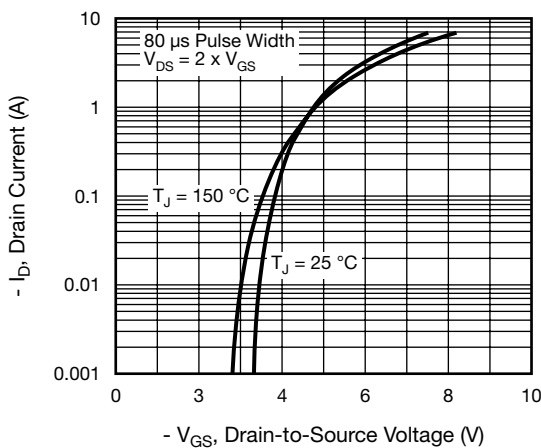

Fig. 3 - Typical Transfer Characteristics

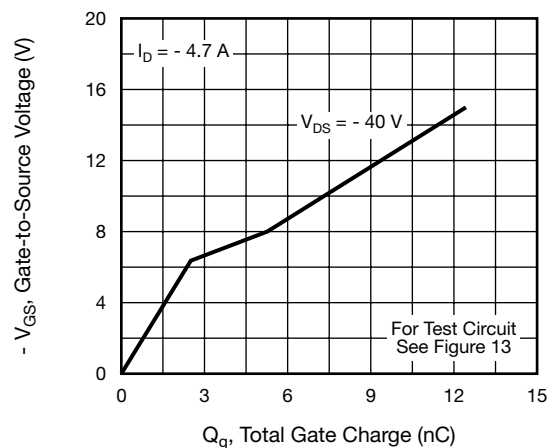

Fig. 6 - Typical Gate Charge vs. Gate-to-Source Voltage

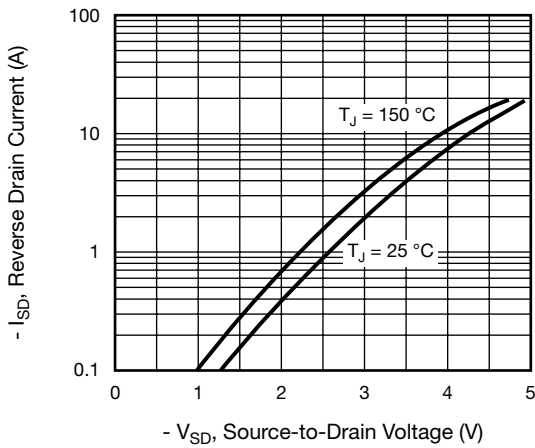

Fig. 7 - Typical Source-Drain Diode Forward Voltage

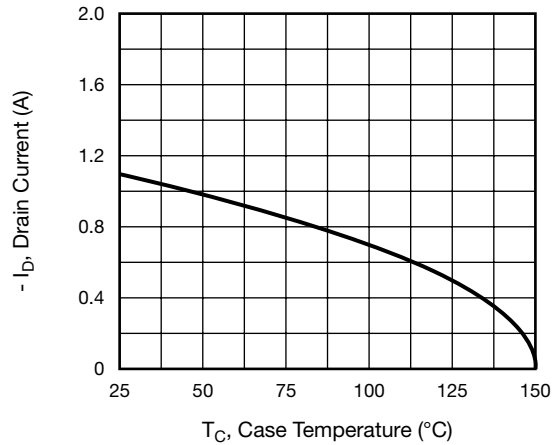

Fig. 9 - Maximum Drain Current vs. Case Temperature

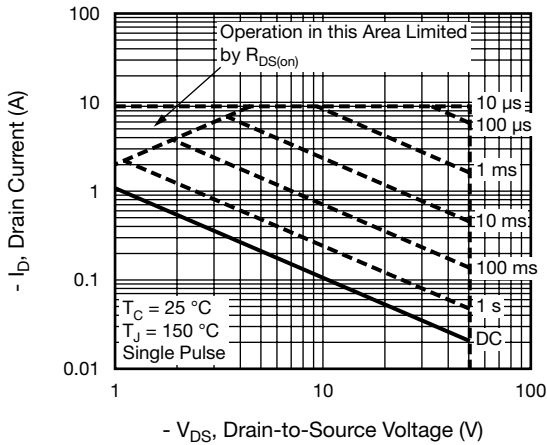

Fig. 8 - Maximum Safe Operating Area

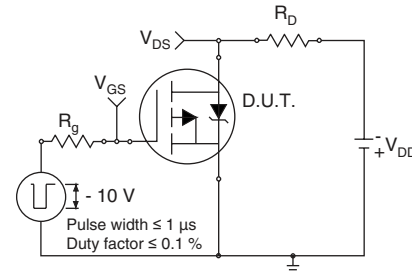

Fig. 10a - Switching Time Test Circuit

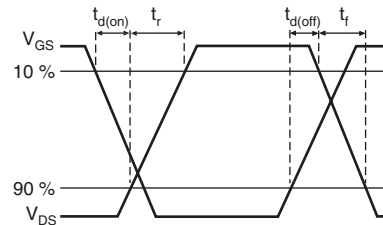

Fig. 10b - Switching Time Waveforms

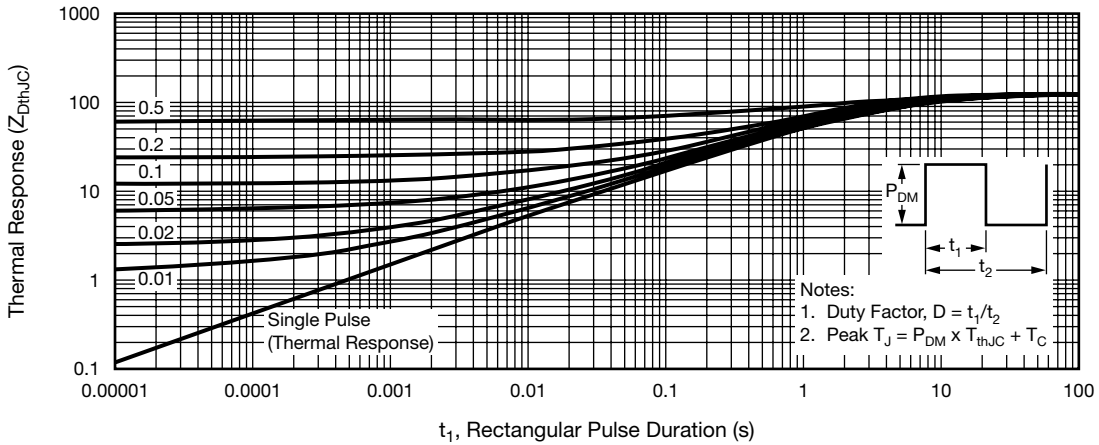

Fig. 11 - Maximum Effective Transient Thermal Impedance, Junction-to-Case

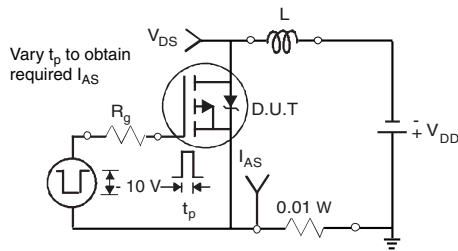

Fig. 12a - Unclamped Inductive Test Circuit

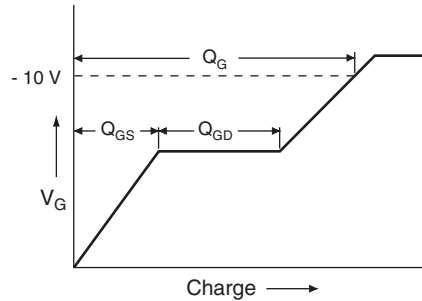

Fig. 13a - Basic Gate Charge Waveform

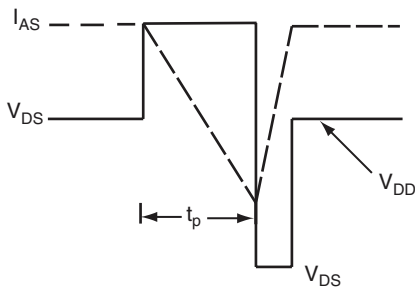

Fig. 12b - Unclamped Inductive Waveforms

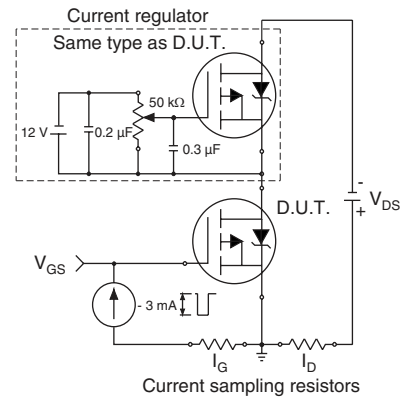
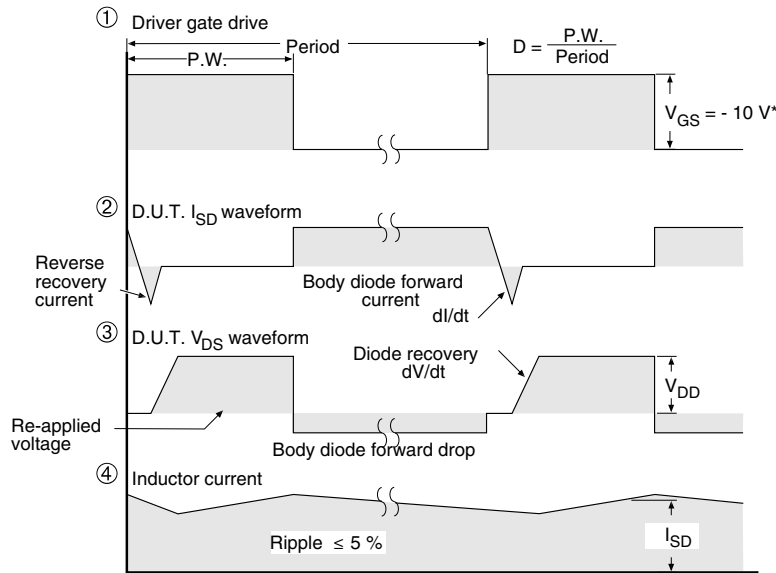
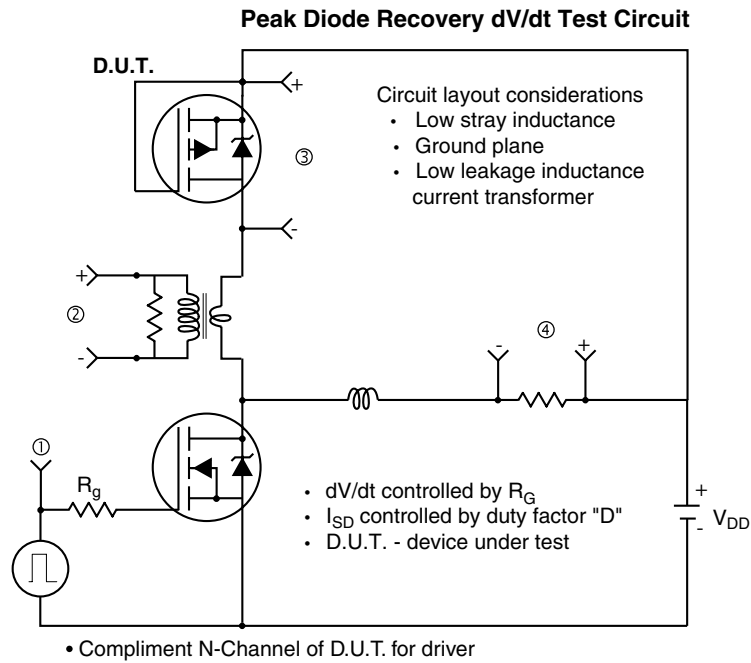

Fig. 13b - Gate Charge Test Circuit



* $V_{GS} = -5 V$ for logic level and $-3 V$ drive devices

Fig. 14 - For P-Channel

Vishay Siliconix maintains worldwide manufacturing capability. Products may be manufactured at one of several qualified locations. Reliability data for Silicon Technology and Package Reliability represent a composite of all qualified locations. For related documents such as package/tape drawings, part marking, and reliability data, see www.vishay.com/ppg?91405.



Disclaimer

ALL PRODUCT, PRODUCT SPECIFICATIONS AND DATA ARE SUBJECT TO CHANGE WITHOUT NOTICE TO IMPROVE RELIABILITY, FUNCTION OR DESIGN OR OTHERWISE.

Vishay Intertechnology, Inc., its affiliates, agents, and employees, and all persons acting on its or their behalf (collectively, "Vishay"), disclaim any and all liability for any errors, inaccuracies or incompleteness contained in any datasheet or in any other disclosure relating to any product.

Vishay makes no warranty, representation or guarantee regarding the suitability of the products for any particular purpose or the continuing production of any product. To the maximum extent permitted by applicable law, Vishay disclaims (i) any and all liability arising out of the application or use of any product, (ii) any and all liability, including without limitation special, consequential or incidental damages, and (iii) any and all implied warranties, including warranties of fitness for particular purpose, non-infringement and merchantability.

Statements regarding the suitability of products for certain types of applications are based on Vishay's knowledge of typical requirements that are often placed on Vishay products in generic applications. Such statements are not binding statements about the suitability of products for a particular application. It is the customer's responsibility to validate that a particular product with the properties described in the product specification is suitable for use in a particular application. Parameters provided in datasheets and/or specifications may vary in different applications and performance may vary over time. All operating parameters, including typical parameters, must be validated for each customer application by the customer's technical experts. Product specifications do not expand or otherwise modify Vishay's terms and conditions of purchase, including but not limited to the warranty expressed therein.

Except as expressly indicated in writing, Vishay products are not designed for use in medical, life-saving, or life-sustaining applications or for any other application in which the failure of the Vishay product could result in personal injury or death. Customers using or selling Vishay products not expressly indicated for use in such applications do so at their own risk and agree to fully indemnify and hold Vishay and its distributors harmless from and against any and all claims, liabilities, expenses and damages arising or resulting in connection with such use or sale, including attorneys fees, even if such claim alleges that Vishay or its distributor was negligent regarding the design or manufacture of the part. Please contact authorized Vishay personnel to obtain written terms and conditions regarding products designed for such applications.

No license, express or implied, by estoppel or otherwise, to any intellectual property rights is granted by this document or by any conduct of Vishay. Product names and markings noted herein may be trademarks of their respective owners.

Material Category Policy

Vishay Intertechnology, Inc. hereby certifies that all its products that are identified as RoHS-Compliant fulfill the definitions and restrictions defined under Directive 2011/65/EU of The European Parliament and of the Council of June 8, 2011 on the restriction of the use of certain hazardous substances in electrical and electronic equipment (EEE) - recast, unless otherwise specified as non-compliant.

Please note that some Vishay documentation may still make reference to RoHS Directive 2002/95/EC. We confirm that all the products identified as being compliant to Directive 2002/95/EC conform to Directive 2011/65/EU.