



N-Channel 20 V (D-S) MOSFET

PRODUCT SUMMARY			
V _{DS} (V)	R _{DS(on)} (Ω)	I _D (A) ^a	Q _g (Typ.)
20	0.033 at V _{GS} = 4.5 V	4	6 nC
	0.038 at V _{GS} = 2.5 V	4	
	0.045 at V _{GS} = 1.8 V	4	
	0.070 at V _{GS} = 1.5 V	3	

FEATURES

- Halogen-free According to IEC 61249-2-21 Definition
- TrenchFET[®] Power MOSFET
- Typical ESD Protection 4000 V
- 100 % R_g Tested
- Compliant to RoHS Directive 2002/95/EC



RoHS
COMPLIANT
HALOGEN
FREE

APPLICATIONS

- Portable Devices
 - Load Switch
 - Battery Switch

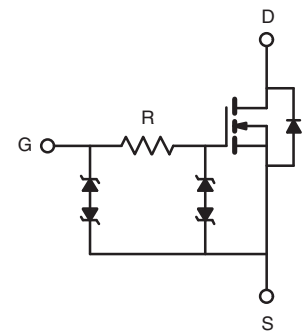
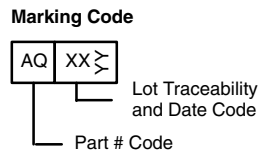
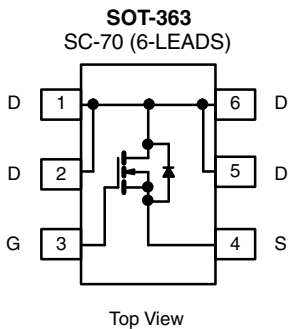

Ordering Information: Si1424EDH-T1-GE3 (Lead (Pb)-free and Halogen-free)

ABSOLUTE MAXIMUM RATINGS (T _A = 25 °C, unless otherwise noted)				
Parameter	Symbol	Limit	Unit	
Drain-Source Voltage	V _{DS}	20	V	
Gate-Source Voltage	V _{GS}	± 8		
Continuous Drain Current (T _J = 150 °C)	I _D	T _C = 25 °C	A	
		T _C = 70 °C		
		T _A = 25 °C		
		T _A = 70 °C		
Pulsed Drain Current	I _{DM}	16		
Continuous Source-Drain Diode Current	I _S	T _C = 25 °C	W	
		T _A = 25 °C		
Maximum Power Dissipation	P _D	T _C = 25 °C		
		T _C = 70 °C		
		T _A = 25 °C		
		T _A = 70 °C		
Operating Junction and Storage Temperature Range	T _J , T _{stg}	- 55 to 150	°C	

THERMAL RESISTANCE RATINGS					
Parameter	Symbol	Typical	Maximum	Unit	
Maximum Junction-to-Ambient ^{b, d}	R _{thJA}	60	80	°C/W	
Maximum Junction-to-Foot (Drain)	R _{thJF}	34	45		

Notes:

- Package limited, T_C = 25 °C.
- Surface mounted on 1" x 1" FR4 board.
- t = 5 s.
- Maximum under steady state conditions is 125 °C/W.

SPECIFICATIONS ($T_J = 25\text{ }^\circ\text{C}$, unless otherwise noted)						
Parameter	Symbol	Test Conditions	Min.	Typ.	Max.	Unit
Static						
Drain-Source Breakdown Voltage	V_{DS}	$V_{GS} = 0\text{ V}$, $I_D = 250\text{ }\mu\text{A}$	20			V
V_{DS} Temperature Coefficient	$\Delta V_{DS}/T_J$	$I_D = 250\text{ }\mu\text{A}$		18		mV/ $^\circ\text{C}$
$V_{GS(th)}$ Temperature Coefficient	$\Delta V_{GS(th)}/T_J$			-2.5		
Gate-Source Threshold Voltage	$V_{GS(th)}$	$V_{DS} = V_{GS}$, $I_D = 250\text{ }\mu\text{A}$	0.4		1.0	V
Gate-Source Leakage	I_{GSS}	$V_{DS} = 0\text{ V}$, $V_{GS} = \pm 4.5\text{ V}$			± 1.5	μA
		$V_{DS} = 0\text{ V}$, $V_{GS} = \pm 8\text{ V}$			± 25	
Zero Gate Voltage Drain Current	I_{DSS}	$V_{DS} = 20\text{ V}$, $V_{GS} = 0\text{ V}$			1	
		$V_{DS} = 20\text{ V}$, $V_{GS} = 0\text{ V}$, $T_J = 55\text{ }^\circ\text{C}$			10	
On-State Drain Current ^a	$I_{D(on)}$	$V_{DS} \geq 5\text{ V}$, $V_{GS} = 4.5\text{ V}$	15			A
Drain-Source On-State Resistance ^a	$R_{DS(on)}$	$V_{GS} = 4.5\text{ V}$, $I_D = 5\text{ A}$		0.027	0.033	Ω
		$V_{GS} = 2.5\text{ V}$, $I_D = 1\text{ A}$		0.031	0.038	
		$V_{GS} = 1.8\text{ V}$, $I_D = 1\text{ A}$		0.035	0.045	
		$V_{GS} = 1.5\text{ V}$, $I_D = 0.5\text{ A}$		0.040	0.070	
Forward Transconductance ^a	g_{fs}	$V_{DS} = 10\text{ V}$, $I_D = 3\text{ A}$		25		S
Dynamic^b						
Total Gate Charge	Q_g	$V_{DS} = 10\text{ V}$, $V_{GS} = 8\text{ V}$, $I_D = 7.1\text{ A}$		11.5	18	nC
				6	9	
				0.8		
Gate-Source Charge	Q_{gs}	$V_{DS} = 10\text{ V}$, $V_{GS} = 4.5\text{ V}$, $I_D = 7.1\text{ A}$		1.6		
Gate-Drain Charge	Q_{gd}					
Gate Resistance	R_g	$f = 1\text{ MHz}$	0.46	2.3	4.6	k Ω
Turn-On Delay Time	$t_{d(on)}$	$V_{DD} = 10\text{ V}$, $R_L = 1.8\text{ }\Omega$ $I_D = 5.7\text{ A}$, $V_{GEN} = 4.5\text{ V}$, $R_g = 1\text{ }\Omega$		0.3	0.45	μs
Rise Time	t_r			0.6	0.9	
Turn-Off Delay Time	$t_{d(off)}$			3.8	6	
Fall Time	t_f			1.7	2.6	
Turn-On Delay Time	$t_{d(on)}$	$V_{DD} = 10\text{ V}$, $R_L = 1.8\text{ }\Omega$ $I_D = 5.7\text{ A}$, $V_{GEN} = 10\text{ V}$, $R_g = 1\text{ }\Omega$		0.15	0.25	
Rise Time	t_r			0.3	0.45	
Turn-Off Delay Time	$t_{d(off)}$			5.6	9	
Fall Time	t_f			1.6	2.5	
Drain-Source Body Diode Characteristics						
Continuous Source-Drain Diode Current	I_S	$T_C = 25\text{ }^\circ\text{C}$			2.3	A
Pulse Diode Forward Current	I_{SM}				16	
Body Diode Voltage	V_{SD}	$I_S = 5.7\text{ A}$, $V_{GS} = 0\text{ V}$		0.85	1.2	V
Body Diode Reverse Recovery Time	t_{rr}	$I_F = 5.7\text{ A}$, $di/dt = 100\text{ A}/\mu\text{s}$, $T_J = 25\text{ }^\circ\text{C}$		15	30	ns
Body Diode Reverse Recovery Charge	Q_{rr}			7.5	15	nC
Reverse Recovery Fall Time	t_a			8		ns
Reverse Recovery Rise Time	t_b			15		

Notes:

- a. Pulse test; pulse width $\leq 300\text{ }\mu\text{s}$, duty cycle $\leq 2\%$.
b. Guaranteed by design, not subject to production testing.

Stresses beyond those listed under "Absolute Maximum Ratings" may cause permanent damage to the device. These are stress ratings only, and functional operation of the device at these or any other conditions beyond those indicated in the operational sections of the specifications is not implied. Exposure to absolute maximum rating conditions for extended periods may affect device reliability.



TYPICAL CHARACTERISTICS ($T_A = 25\text{ }^\circ\text{C}$, unless otherwise noted)

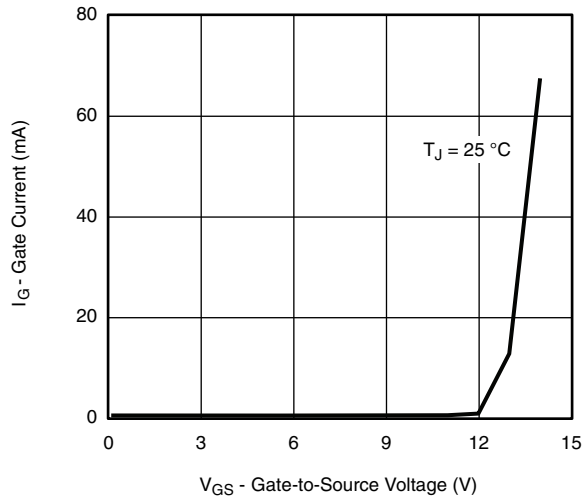

Gate Current vs. Gate-to-Source Voltage

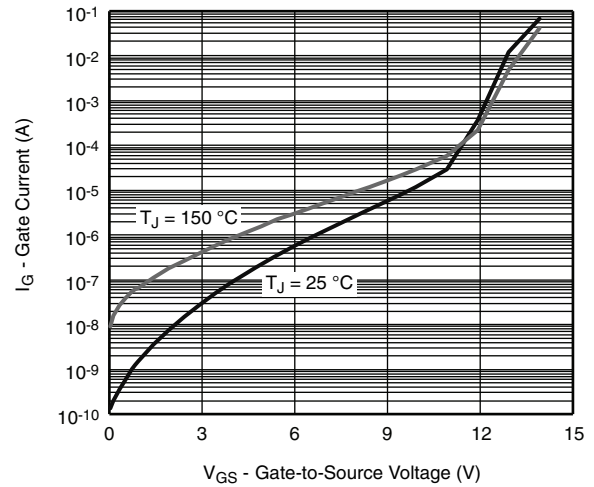

Gate Current vs. Gate-to-Source Voltage

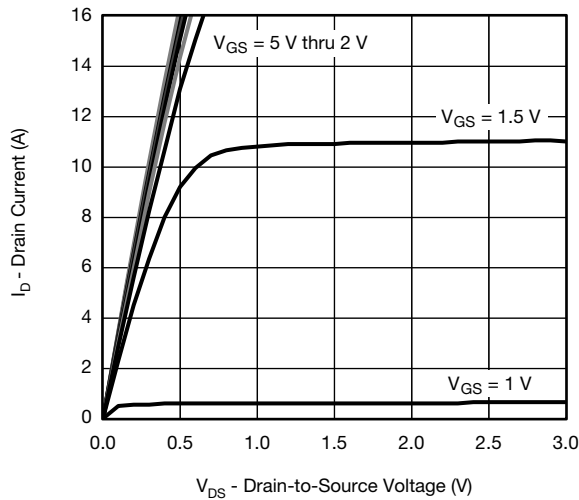

Output Characteristics

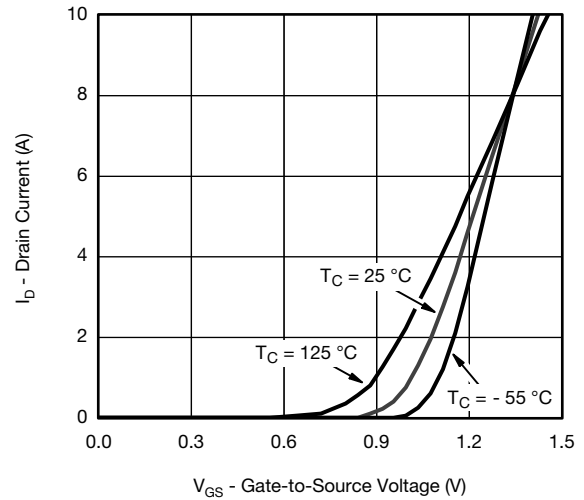

Transfer Characteristics

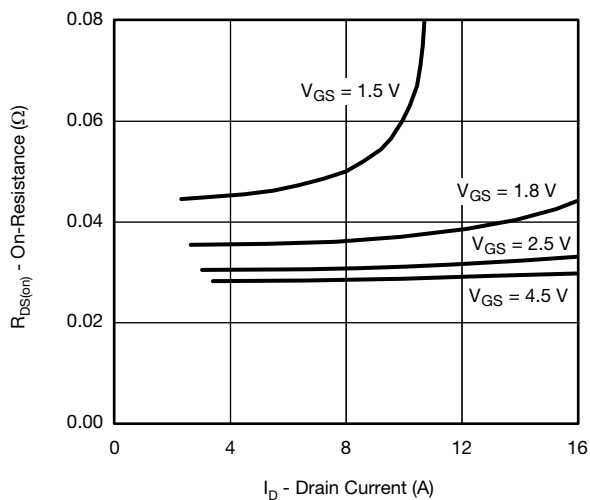

On-Resistance vs. Drain Current

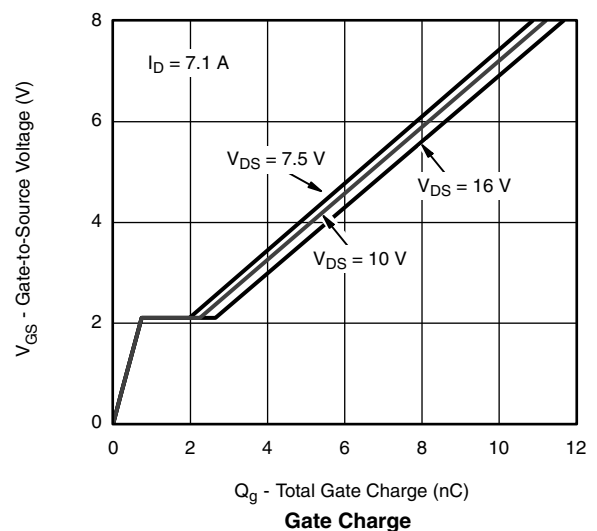

Gate Charge

Si1424EDH

Vishay Siliconix



TYPICAL CHARACTERISTICS (T_A = 25 °C, unless otherwise noted)

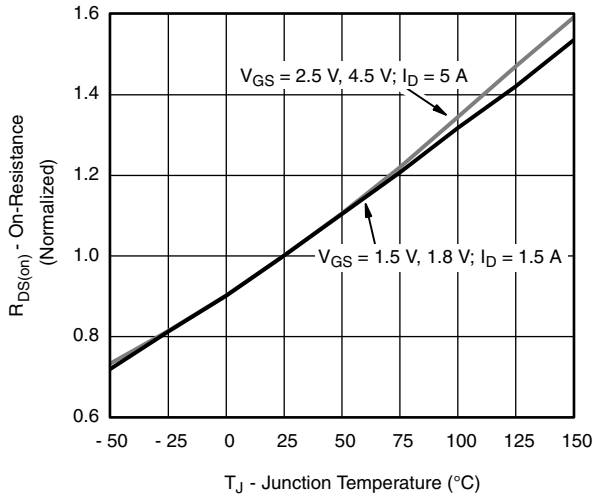

Normalized On-Resistance vs. Junction Temperature

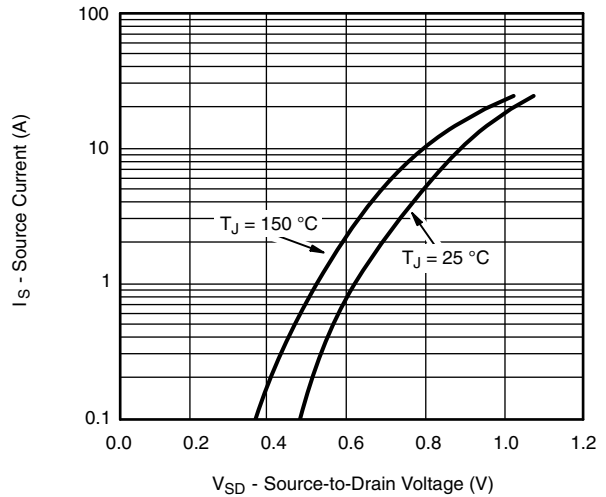

Source-Drain Diode Forward Voltage

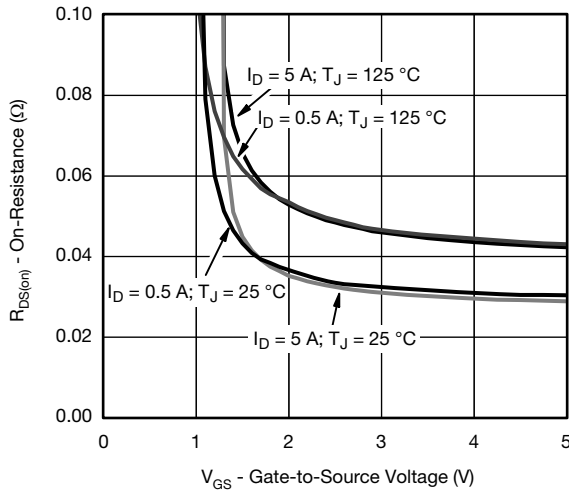

On-Resistance vs. Gate-to-Source Voltage

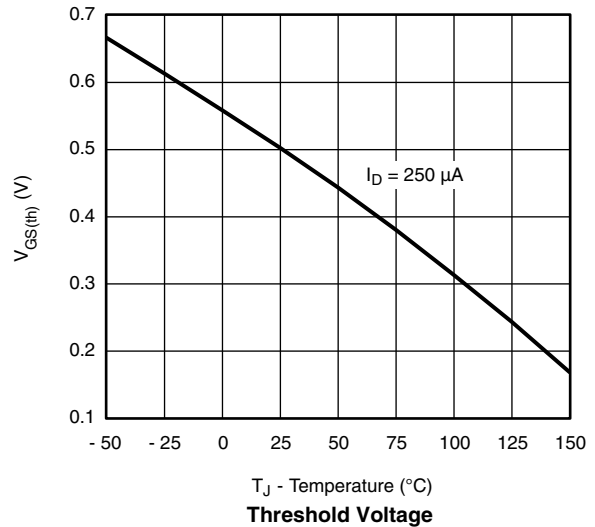

Threshold Voltage

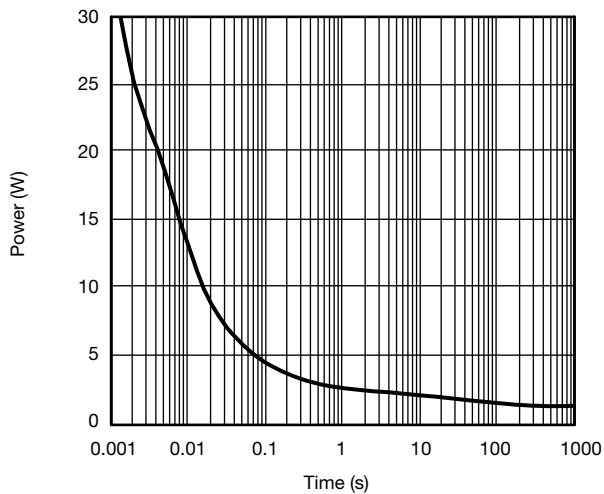

Single Pulse Power, Junction-to-Ambient

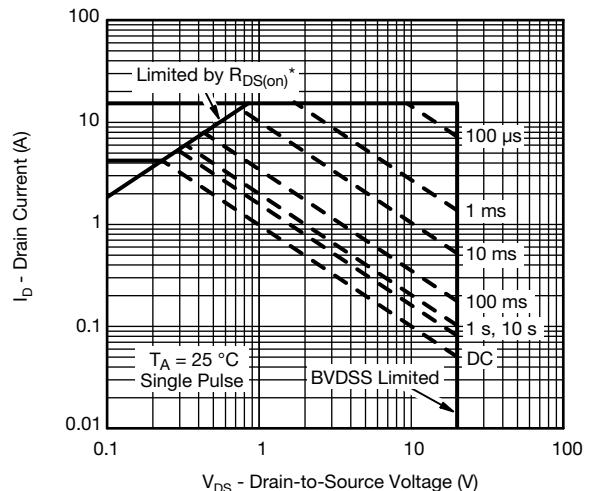

* V_{GS} > minimum V_{GS} at which R_{DS(on)} is specified

Safe Operating Area, Junction-to-Ambient



TYPICAL CHARACTERISTICS ($T_A = 25\text{ }^\circ\text{C}$, unless otherwise noted)

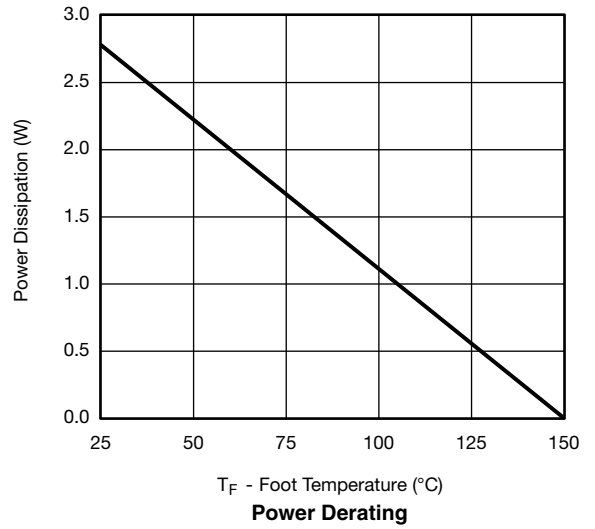
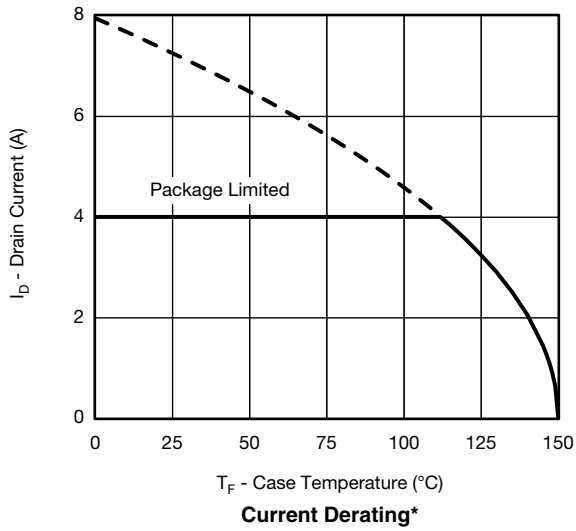

* The power dissipation P_D is based on $T_{J(max)} = 150\text{ }^\circ\text{C}$, using junction-to-case thermal resistance, and is more useful in settling the upper dissipation limit for cases where additional heatsinking is used. It is used to determine the current rating, when this rating falls below the package limit.



TYPICAL CHARACTERISTICS ($T_A = 25\text{ }^\circ\text{C}$, unless otherwise noted)

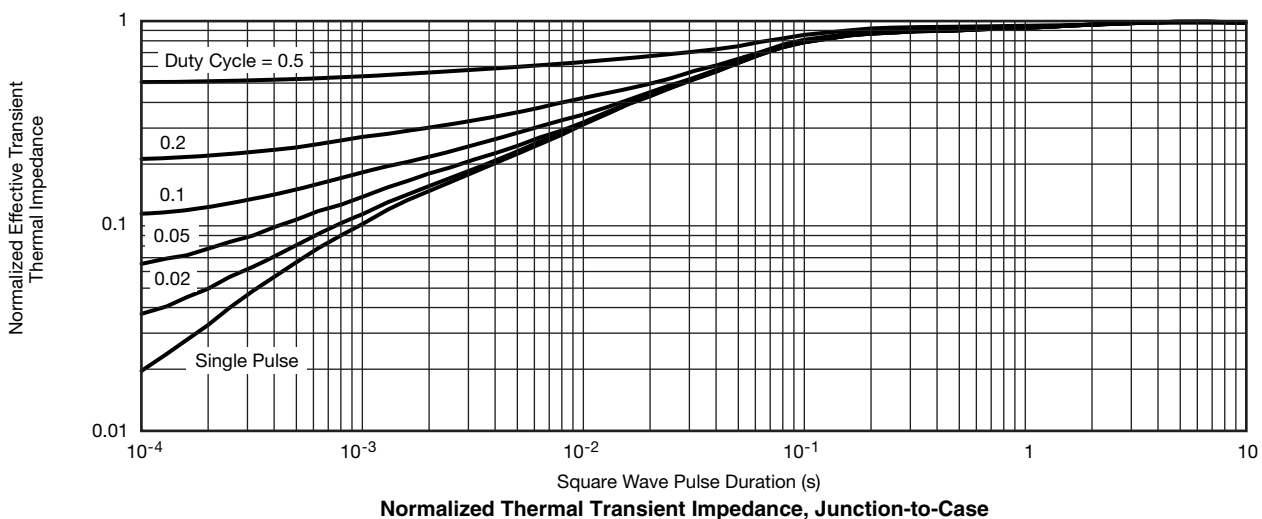
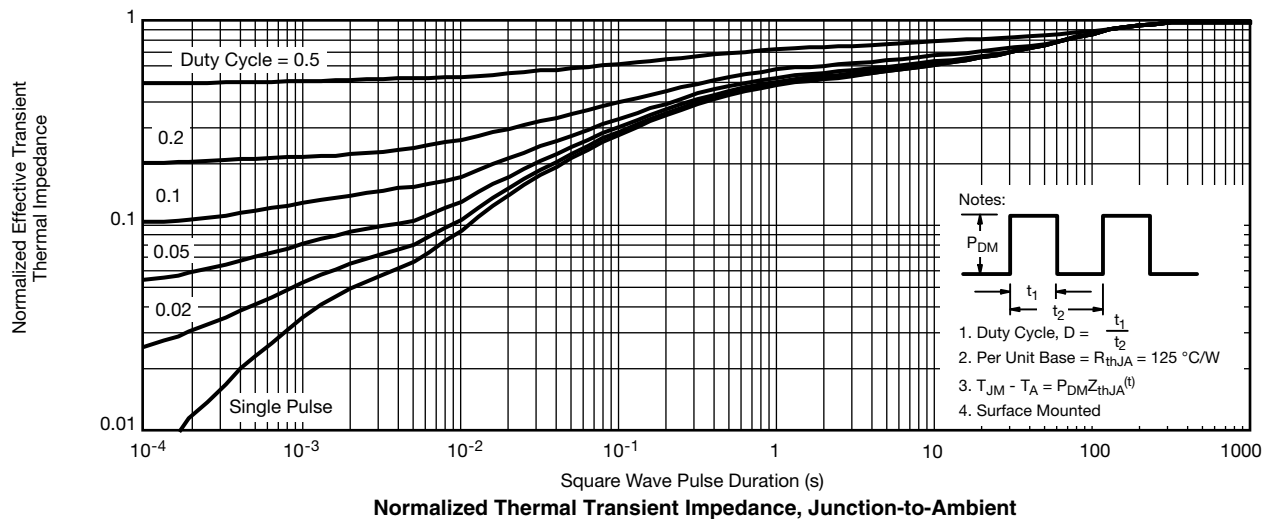

Vishay Siliconix maintains worldwide manufacturing capability. Products may be manufactured at one of several qualified locations. Reliability data for Silicon Technology and Package Reliability represent a composite of all qualified locations. For related documents such as package/tape drawings, part marking, and reliability data, see www.vishay.com/ppg?67198.

SC-70: 6-LEADS



Dim	MILLIMETERS			INCHES		
	Min	Nom	Max	Min	Nom	Max
A	0.90	-	1.10	0.035	-	0.043
A ₁	-	-	0.10	-	-	0.004
A ₂	0.80	-	1.00	0.031	-	0.039
b	0.15	-	0.30	0.006	-	0.012
c	0.10	-	0.25	0.004	-	0.010
D	1.80	2.00	2.20	0.071	0.079	0.087
E	1.80	2.10	2.40	0.071	0.083	0.094
E ₁	1.15	1.25	1.35	0.045	0.049	0.053
e	0.65BSC			0.026BSC		
e ₁	1.20	1.30	1.40	0.047	0.051	0.055
L	0.10	0.20	0.30	0.004	0.008	0.012
α	7°Nom			7°Nom		

ECN: S-03946—Rev. B, 09-Jul-01
DWG: 5550

Single-Channel LITTLE FOOT® SC-70 6-Pin MOSFET Copper Leadframe Version Recommended Pad Pattern and Thermal Performance

INTRODUCTION

The new single 6-pin SC-70 package with a copper leadframe enables improved on-resistance values and enhanced thermal performance as compared to the existing 3-pin and 6-pin packages with Alloy 42 leadframes. These devices are intended for small to medium load applications where a miniaturized package is required. Devices in this package come in a range of on-resistance values, in n-channel and p-channel versions. This technical note discusses pin-outs, package outlines, pad patterns, evaluation board layout, and thermal performance for the single-channel version.

BASIC PAD PATTERNS

See Application Note 826, *Recommended Minimum Pad Patterns With Outline Drawing Access for Vishay Siliconix MOSFETs*, (<http://www.vishay.com/doc?72286>) for the basic pad layout and dimensions. These pad patterns are sufficient for the low to medium power applications for which this package is intended. Increasing the drain pad pattern yields a reduction in thermal resistance and is a preferred footprint. The availability of four drain leads rather than the traditional single drain lead allows a better thermal path from the package to the PCB and external environment.

PIN-OUT

Figure 1 shows the pin-out description and Pin 1 identification. The pin-out of this device allows the use of four pins as drain leads, which helps to reduce on-resistance and junction-to-ambient thermal resistance.



Top View

FIGURE 1.

For package dimensions see outline drawing SC-70 (6-Leads) (<http://www.vishay.com/doc?71154>)

EVALUATION BOARDS — SINGLE SC70-6

The evaluation board (EVB) measures 0.6 inches by 0.5 inches. The copper pad traces are the same as in Figure 2. The board allows examination from the outer pins to 6-pin DIP connections, permitting test sockets to be used in evaluation testing. See Figure 3.



FIGURE 2. SC-70 (6 leads) Single

The thermal performance of the single 6-pin SC-70 has been measured on the EVB, comparing both the copper and Alloy 42 leadframes. This test was first conducted on the traditional Alloy 42 leadframe and was then repeated using the 1-inch² PCB with dual-side copper coating.



FIGURE 3.

THERMAL PERFORMANCE

Junction-to-Foot Thermal Resistance (Package Performance)

The junction to foot thermal resistance is a useful method of comparing different packages thermal performance.

A helpful way of presenting the thermal performance of the 6-Pin SC-70 copper leadframe device is to compare it to the traditional Alloy 42 version.

Thermal performance for the 6-pin SC-70 measured as junction-to-foot thermal resistance, where the “foot” is the drain lead of the device at the bottom where it meets the PCB. The junction-to-foot thermal resistance is typically 40°C/W in the copper leadframe and 163°C/W in the Alloy 42 leadframe — a four-fold improvement. This improved performance is obtained by the enhanced thermal conductivity of copper over Alloy 42.

Power Dissipation

The typical $R_{\theta JA}$ for the single 6-pin SC-70 with copper leadframe is 103°C/W steady-state, compared with 212°C/W for the Alloy 42 version. The figures are based on the 1-inch² FR4 test board. The following example shows how the thermal resistance impacts power dissipation for the two different leadframes at varying ambient temperatures.

ALLOY 42 LEADFRAME	
Room Ambient 25 °C	Elevated Ambient 60 °C
$P_D = \frac{T_{J(max)} - T_A}{R_{\theta JA}}$	$P_D = \frac{T_{J(max)} - T_A}{R_{\theta JA}}$
$P_D = \frac{150^{\circ}\text{C} - 25^{\circ}\text{C}}{212^{\circ}\text{C}/\text{W}}$	$P_D = \frac{150^{\circ}\text{C} - 25^{\circ}\text{C}}{212^{\circ}\text{C}/\text{W}}$
$P_D = 590 \text{ mW}$	$P_D = 425 \text{ mW}$

COOPER LEADFRAME	
Room Ambient 25 °C	Elevated Ambient 60 °C
$P_D = \frac{T_{J(max)} - T_A}{R_{\theta JA}}$	$P_D = \frac{T_{J(max)} - T_A}{R_{\theta JA}}$
$P_D = \frac{150^{\circ}\text{C} - 25^{\circ}\text{C}}{124^{\circ}\text{C}/\text{W}}$	$P_D = \frac{150^{\circ}\text{C} - 60^{\circ}\text{C}}{124^{\circ}\text{C}/\text{W}}$
$P_D = 1.01 \text{ W}$	$P_D = 726 \text{ mW}$

As can be seen from the calculations above, the compact 6-pin SC-70 copper leadframe LITTLE FOOT power MOSFET can handle up to 1 W under the stated conditions.

Testing

To further aid comparison of copper and Alloy 42 leadframes, Figure 5 illustrates single-channel 6-pin SC-70 thermal performance on two different board sizes and two different pad patterns. The measured steady-state values of $R_{\theta JA}$ for the two leadframes are as follows:

LITTLE FOOT 6-PIN SC-70		
	Alloy 42	Copper
1) Minimum recommended pad pattern on the EVB board V (see Figure 3).	329.7°C/W	208.5°C/W
2) Industry standard 1-inch ² PCB with maximum copper both sides.	211.8°C/W	103.5°C/W

The results indicate that designers can reduce thermal resistance ($R_{\theta JA}$) by 36% simply by using the copper leadframe device rather than the Alloy 42 version. In this example, a 121°C/W reduction was achieved without an increase in board area. If increasing in board size is feasible, a further 105°C/W reduction could be obtained by utilizing a 1-inch² square PCB area.

The copper leadframe versions have the following suffix:

Single: Si14xxEDH
 Dual: Si19xxEDH
 Complementary: Si15xxEDH



FIGURE 4. Leadframe Comparison on EVB



FIGURE 5. Leadframe Comparison on Alloy 42 1-inch² PCB

RECOMMENDED MINIMUM PADS FOR SC-70: 6-Lead



Recommended Minimum Pads
Dimensions in Inches/(mm)

[Return to Index](#)



Disclaimer

ALL PRODUCT, PRODUCT SPECIFICATIONS AND DATA ARE SUBJECT TO CHANGE WITHOUT NOTICE TO IMPROVE RELIABILITY, FUNCTION OR DESIGN OR OTHERWISE.

Vishay Intertechnology, Inc., its affiliates, agents, and employees, and all persons acting on its or their behalf (collectively, "Vishay"), disclaim any and all liability for any errors, inaccuracies or incompleteness contained in any datasheet or in any other disclosure relating to any product.

Vishay makes no warranty, representation or guarantee regarding the suitability of the products for any particular purpose or the continuing production of any product. To the maximum extent permitted by applicable law, Vishay disclaims (i) any and all liability arising out of the application or use of any product, (ii) any and all liability, including without limitation special, consequential or incidental damages, and (iii) any and all implied warranties, including warranties of fitness for particular purpose, non-infringement and merchantability.

Statements regarding the suitability of products for certain types of applications are based on Vishay's knowledge of typical requirements that are often placed on Vishay products in generic applications. Such statements are not binding statements about the suitability of products for a particular application. It is the customer's responsibility to validate that a particular product with the properties described in the product specification is suitable for use in a particular application. Parameters provided in datasheets and/or specifications may vary in different applications and performance may vary over time. All operating parameters, including typical parameters, must be validated for each customer application by the customer's technical experts. Product specifications do not expand or otherwise modify Vishay's terms and conditions of purchase, including but not limited to the warranty expressed therein.

Except as expressly indicated in writing, Vishay products are not designed for use in medical, life-saving, or life-sustaining applications or for any other application in which the failure of the Vishay product could result in personal injury or death. Customers using or selling Vishay products not expressly indicated for use in such applications do so at their own risk. Please contact authorized Vishay personnel to obtain written terms and conditions regarding products designed for such applications.

No license, express or implied, by estoppel or otherwise, to any intellectual property rights is granted by this document or by any conduct of Vishay. Product names and markings noted herein may be trademarks of their respective owners.

Material Category Policy

Vishay Intertechnology, Inc. hereby certifies that all its products that are identified as RoHS-Compliant fulfill the definitions and restrictions defined under Directive 2011/65/EU of The European Parliament and of the Council of June 8, 2011 on the restriction of the use of certain hazardous substances in electrical and electronic equipment (EEE) - recast, unless otherwise specified as non-compliant.

Please note that some Vishay documentation may still make reference to RoHS Directive 2002/95/EC. We confirm that all the products identified as being compliant to Directive 2002/95/EC conform to Directive 2011/65/EU.

Vishay Intertechnology, Inc. hereby certifies that all its products that are identified as Halogen-Free follow Halogen-Free requirements as per JEDEC JS709A standards. Please note that some Vishay documentation may still make reference to the IEC 61249-2-21 definition. We confirm that all the products identified as being compliant to IEC 61249-2-21 conform to JEDEC JS709A standards.