

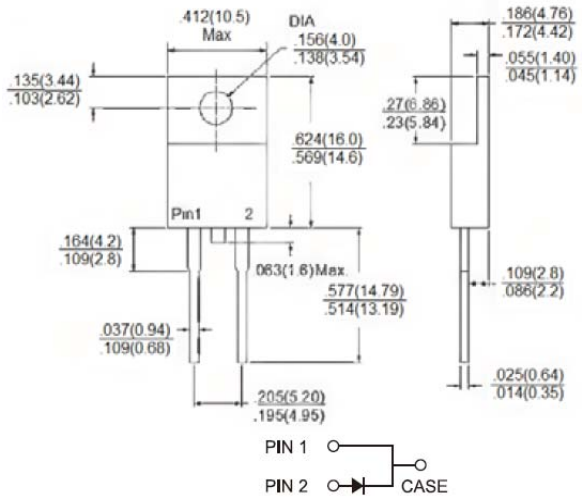

## SFA1001G - SFA1008G 10.0AMPS Glass Passivated Super Fast Rectifier TO-220AC

### Features

- ◇ High efficiency, low VF
- ◇ High current capability
- ◇ High reliability
- ◇ High surge current capability
- ◇ Low power loss
- ◇ For use in low voltage, high frequency inverter, Free wheeling, and polarity protection application
- ◇ Green compound with suffix "G" on packing code & prefix "G" on datecode



### Mechanical Data

- ◇ Case: TO-220AC Molded plastic
- ◇ Epoxy: UL 94V-0 rate flame retardant
- ◇ Terminals: Pure tin plated, lead free, solderable per MIL-STD-202, Method 208 guaranteed
- ◇ Polarity: As marked
- ◇ High temperature soldering: 260°C/10 seconds/.16",(4.06mm) from case
- ◇ Weight: 1.9 grams

### Dimensions in inches and (millimeters)

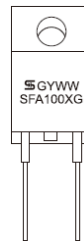

### Marking Diagram

- SFA100XG = Specific Device Code  
 G = Green Compound  
 Y = Year  
 WW = Work Week

### Maximum Ratings and Electrical Characteristics

Rating at 25 °C ambient temperature unless otherwise specified.

Single phase, half wave, 60 Hz, resistive or inductive load.

For capacitive load, derate current by 20%

Type Number	Symbol	SFA 1001G	SFA 1002G	SFA 1003G	SFA 1004G	SFA 1005G	SFA 1006G	SFA 1007G	SFA 1008G	Unit
Maximum Repetitive Peak Reverse Voltage	$V_{RRM}$	50	100	150	200	300	400	500	600	V
Maximum RMS Voltage	$V_{RMS}$	35	70	105	140	210	280	350	420	V
Maximum DC Blocking Voltage	$V_{DC}$	50	100	150	200	300	400	500	600	V
Maximum Average Forward Rectified Current	$I_{F(AV)}$	10								A
Peak Forward Surge Current, 8.3 ms Single Half Sine-wave Superimposed on Rated Load (JEDEC method)	$I_{FSM}$	125								A
Maximum Instantaneous Forward Voltage (Note 1) @ 10 A	$V_F$	0.975			1.3		1.7			V
Maximum Reverse Current @ Rated VR $T_A=25^\circ C$ $T_A=125^\circ C$	$I_R$					10		400		uA
Maximum Reverse Recovery Time (Note 2)	$T_{rr}$					35				nS
Typical Junction Capacitance (Note 3)	$C_j$	70				50				pF
Typical Thermal Resistance	$R_{\theta JC}$					3.5				°C/W
Operating Temperature Range	$T_J$					- 65 to + 150				°C
Storage Temperature Range	$T_{STG}$					- 65 to + 150				°C

Note 1: Pulse Test with PW=300 usec, 1% Duty Cycle

Note 2: Reverse Recovery Test Conditions:  $I_F=0.5A$ ,  $I_R=1.0A$ ,  $I_{RR}=0.25A$

Note 3: Measured at 1 MHz and Applied Reverse Voltage of 4.0V D.C.

## RATINGS AND CHARACTERISTIC CURVES (SFA1001G THRU SFA1008G)

FIG.1 FORWARD CURRENT DERATING CURVE

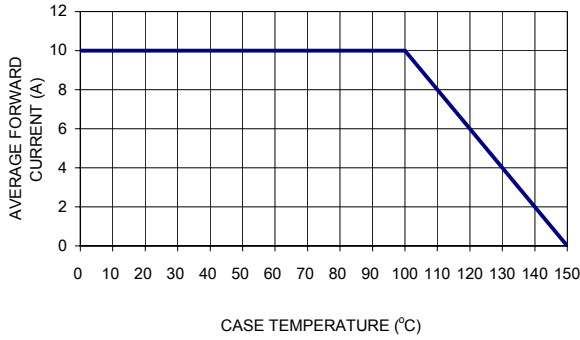

FIG. 2 TYPICAL REVERSE CHARACTERISTICS

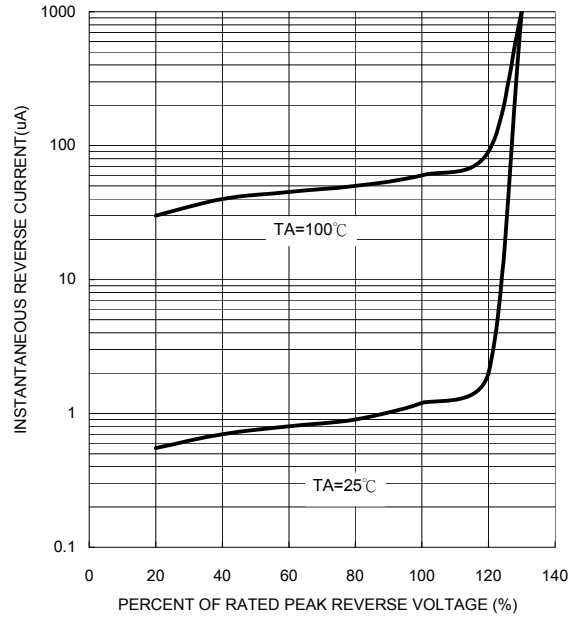

FIG. 3 MAXIMUM NON-REPETITIVE FORWARD SURGE CURRENT

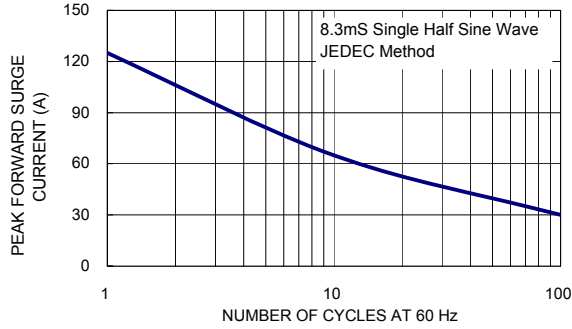

FIG. 5 TYPICAL FORWARD CHARACTERISTICS

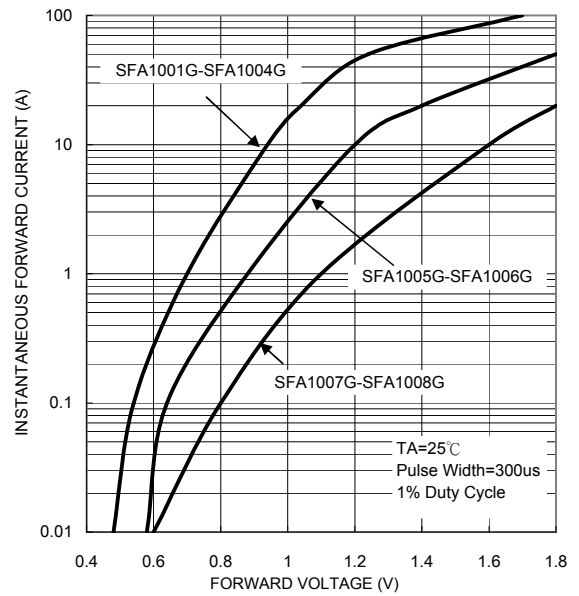

FIG. 4 TYPICAL JUNCTION CAPACITANCE

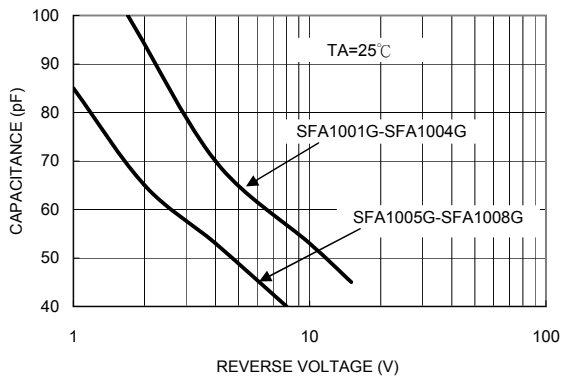

FIG.6- REVERSE RECOVERY TIME CHARACTERISTIC AND TEST CIRCUIT DIAGRAM

