

### Features

- ✧ Low power loss, High efficiency.
- ✧ High current capability, Low VF.
- ✧ High reliability
- ✧ High surge current capability.
- ✧ Epitaxial construction.
- ✧ Guard-ring for transient protection.
- ✧ For use in low voltage, high frequency inverter, free wheeling, and polarity protection application
- ✧ Green compound with suffix "G" on packing code & prefix "G" on datecode.

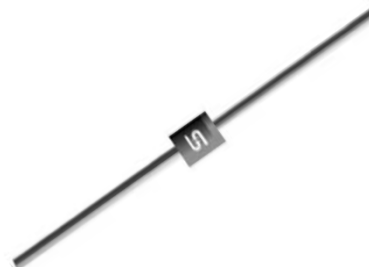

### Mechanical Data

- ✧ Cases: DO-41 molded plastic
- ✧ Epoxy: UL 94V-0 rate flame retardant
- ✧ Lead: Pure tin plated, lead free, solderable per MIL-STD-202, Method 208 guaranteed
- ✧ Polarity: Color band denotes cathode
- ✧ High temperature soldering guaranteed: 260°C / 10 seconds / .375", (9.5mm) lead lengths at 5 lbs, (2.3kg) tension
- ✧ Weight: 0.33 grams

### Ordering Information (example)

Part No.	Package	Packing	INNER TAPE	Packing code	Green Compound Packing code
SR002	DO-41	3K / AMMO box	52mm	A0	A0G

### Maximum Ratings and Electrical Characteristics

Rating at 25 °C ambient temperature unless otherwise specified.

Single phase, half wave, 60 Hz, resistive or inductive load.

For capacitive load, derate current by 20%

Type Number	Symbol	SR 002	SR 003	SR 004	SR 005	SR 006	SR 009	SR 010	Units
Maximum Recurrent Peak Reverse Voltage	$V_{RRM}$	20	30	40	50	60	90	100	V
Maximum RMS Voltage	$V_{RMS}$	14	21	28	35	42	63	70	V
Maximum DC Blocking Voltage	$V_{DC}$	20	30	40	50	60	90	100	V
Maximum Average Forward Rectified Current	$I_{F(AV)}$	0.5							A
Peak Forward Surge Current, 8.3 ms Single Half Sine-wave Superimposed on Rated Load (JEDEC method)	$I_{FSM}$	30							A
Maximum Instantaneous Forward Voltage (Note 1) @ 0.5A	$V_F$	0.55		0.70		0.85		V	
Maximum D.C. Reverse Current at Rated DC Blocking Voltage @ $T_A=25^\circ C$ @ $T_A=100^\circ C$ @ $T_A=125^\circ C$	$I_R$	0.5		0.5		0.1		mA	
		10		5		-			mA
		-		-		2		mA	
Typical Junction Capacitance (Note 2)	$C_j$	110		80		65			pF
Typical Thermal Resistance	$R_{\theta JA}$	50							°C/W
Operating Junction Temperature Range	$T_J$	- 65 to + 125			- 65 to + 150				°C
Storage Temperature Range	$T_{STG}$	- 65 to + 150							°C

Note1: Pulse Test with PW=300 usec, 1% Duty cycle

Note2: Measured at 1 MHz and Applied Reverse Voltage of 4.0V D.C.

RATINGS AND CHARACTERISTIC CURVES (SR002 THRU SR010)

FIG. 1- FORWARD CURRENT DERATING CURVE

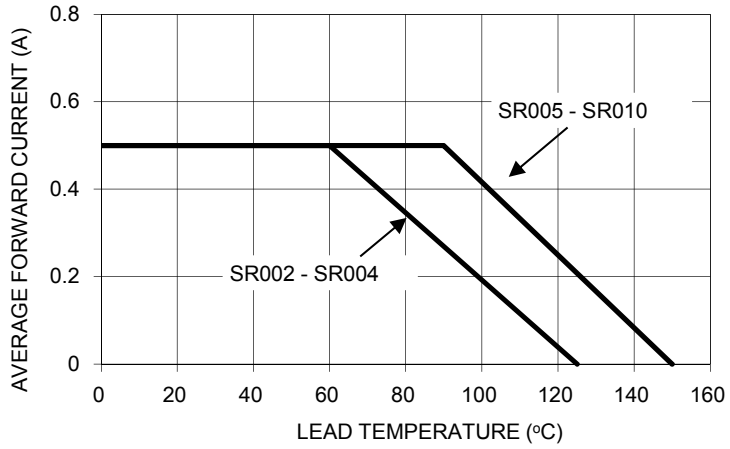

FIG. 2- MAXIMUM NON-REPETITIVE FORWARD SURGE CURRENT

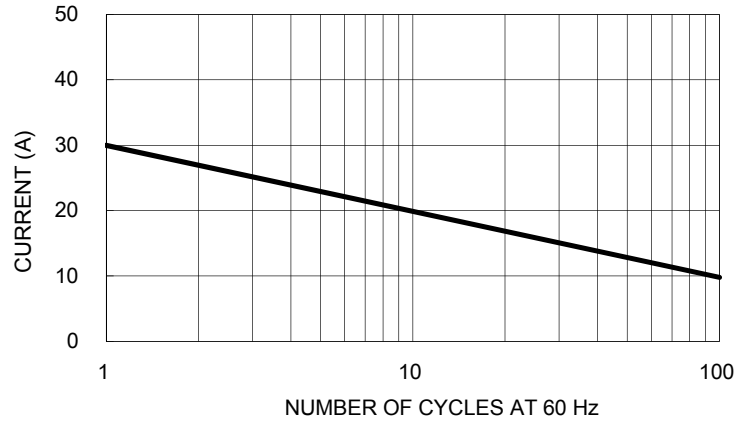

FIG. 3- TYPICAL FORWARD CHARACTERISTICS

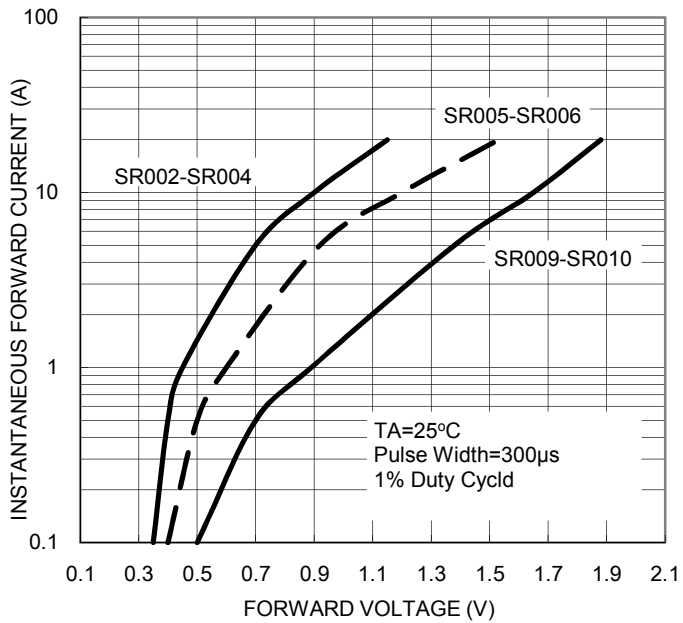

FIG. 4- TYPICAL REVERSE CHARACTERISTICS

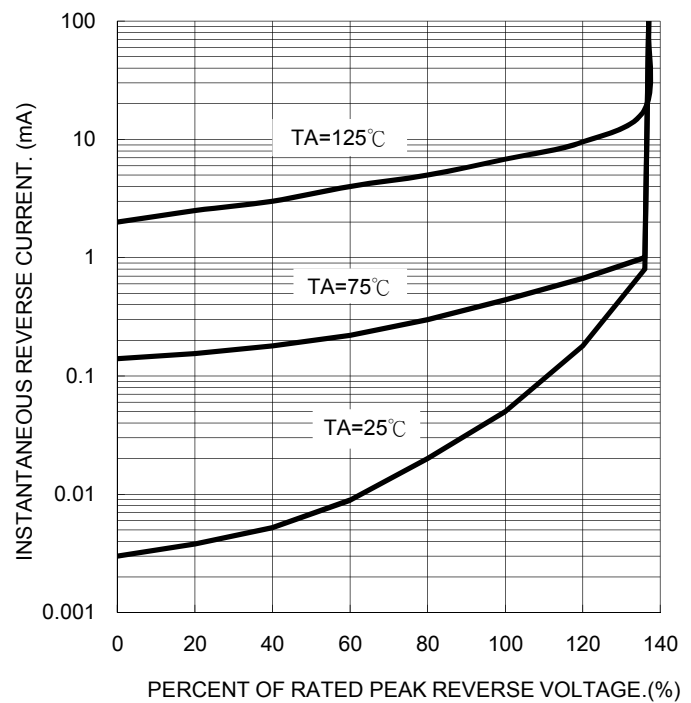

FIG. 5- TYPICAL JUNCTION CAPACITANCE

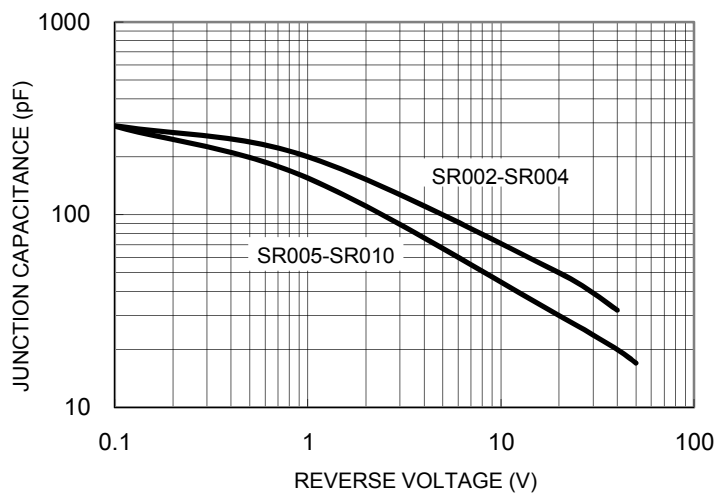
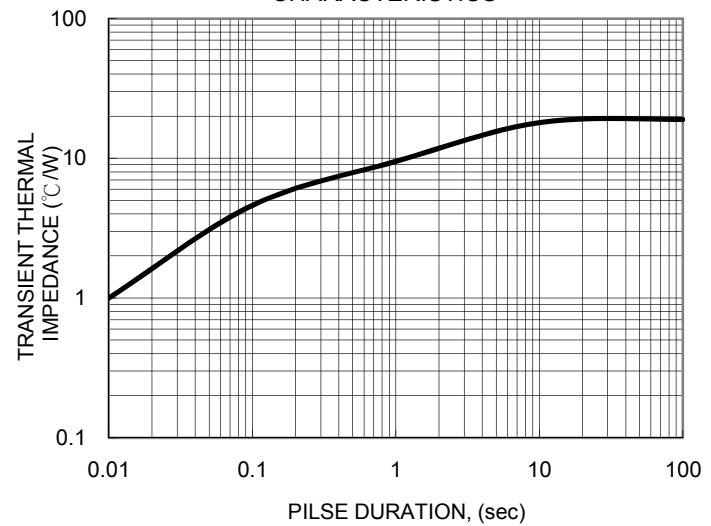

FIG. 6- TYPICAL TRANSIENT THERMAL CHARACTERISTICS



**Ordering information**

Part No.	Package	Packing	INNER TAPE	Packing code	Green Compound Packing code
SR0xx	DO-41	3K / AMMO box	52mm	A0	A0G
	DO-41	5K / 13" Reel	52mm	R0	R0G
	DO-41	5K / 13" Reel	52mm	R1	R1G
	DO-41	1K / Bulk packing		B0	B0G
	DO-41	1K / Bulk packing		X0	X0G

Note: "xx" is Device Code from "02" thru "10".

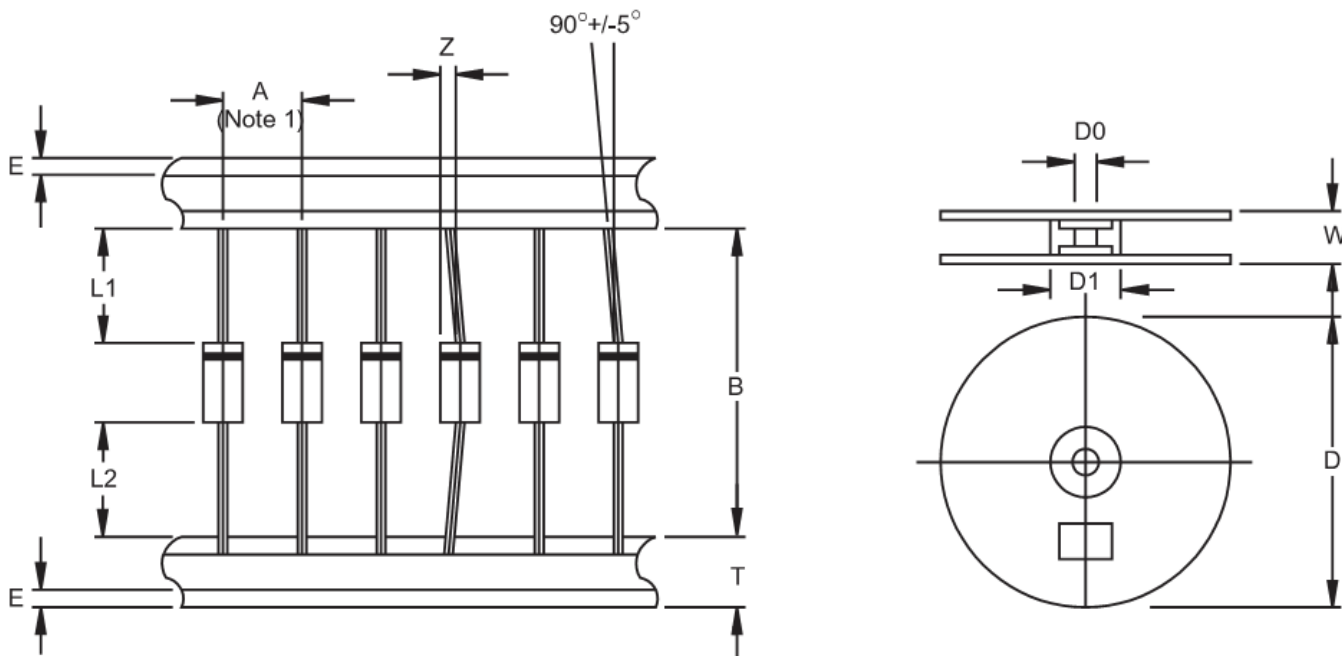
**AXIAL LEAD TAPING SPECIFICATIONS**

Outline	A	B	Z	T	E	L1-L2	D	D1	D0	W
		±0.5	±1.5	MAX	±0.4	MAX	MAX		±0.3	±0.4
DO-41	5	52.4	1.2	6	0.8	1	330	85.7	16.6	76

Unit (mm)

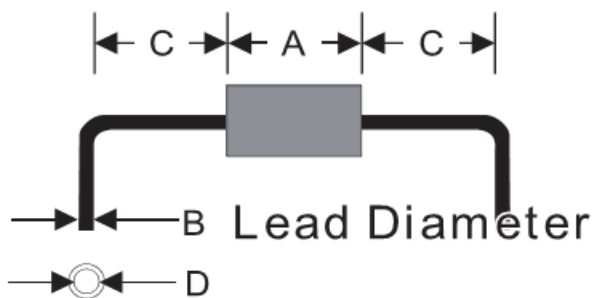
**Suggested Mounting Hole Rule**

Symbol	Unit(mm)
A	5.1
B	0.8
C	3.0
D	1.2

**Dimensions**

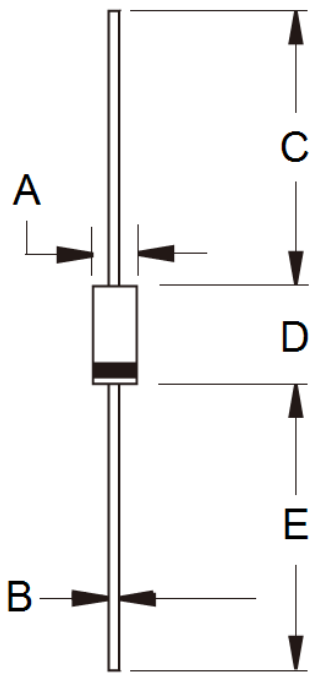

DIM.	Unit(mm)		Unit(inch)	
	Min	Max	Min	Max
A	2.00	2.70	0.079	0.106
B	0.71	0.86	0.028	0.034
C	25.40	-	1.000	-
D	4.20	5.20	0.165	0.205
E	25.40	-	1.000	-

**Marking Diagram**



- P/N = Specific Device Code
- G = Green Compound
- YWW = Date Code