

Features

- ✧ UL Recognized Flie # E-326243
- ✧ Isolated Plastic package.
- ✧ Low power loss, High efficiency.
- ✧ High current capability, Low VF.
- ✧ High reliability
- ✧ High surge current capability.
- ✧ Epitaxial construction.
- ✧ Guard-ring for transient protection.
- ✧ For use in low voltage, high frequency inverter, free wheeling, and polarity protection application
- ✧ Green compound with suffix "G" on packing code & prefix "G" on datecode.



Mechanical Data

- ✧ Cases: ITO-220AC molded plastic
- ✧ Epoxy: UL 94V-0 rate flame retardant
- ✧ Terminals: Pure tin plated, lead free.Solderable per MIL-STD-202, Method 208 guaranteed
- ✧ Polarity: As marked
- ✧ High temperature soldering guaranteed: 260°C/10 seconds /.25", (6.35mm) from case.
- ✧ Weight: 1.73 grams
- ✧ Mounting torque: 5 in - 1bs. Max.

Ordering Information(example)

Part No.	Package	Packing	Packing code	Green Compound Packing code
SRAF1020	ITO-220AC	50 / TUBE	D0	D0G

Maximum Ratings and Electrical Characteristics

Rating at 25 °C ambient temperature unless otherwise specified.

Single phase, half wave, 60 Hz, resistive or inductive load.

For capacitive load, derate current by 20%

Type Number	Symbol	SRAF 1020	SRAF 1030	SRAF 1040	SRAF 1050	SRAF 1060	SRAF 1090	SRAF 1010	SRAF 1015	Units
Maximum Recurrent Peak Reverse Voltage	V_{RRM}	20	30	40	50	60	90	100	150	V
Maximum RMS Voltage	V_{RMS}	14	21	28	35	42	63	70	105	V
Maximum DC Blocking Voltage	V_{DC}	20	30	40	50	60	90	100	150	V
Maximum Average Forward Rectified Current	$I_{F(AV)}$	10								A
Peak Forward Surge Current, 8.3 ms Single Half Sine-wave Superimposed on Rated Load (JEDEC method)	I_{FSM}	200								A
Maximum Instantaneous Forward Voltage (Note 1) @ 10 A	V_F	0.55		0.70		0.85		0.95		V
Maximum D.C. Reverse Current at Rated DC Blocking Voltage @ $T_A=25^\circ C$ @ $T_A=100^\circ C$ @ $T_A=125^\circ C$	I_R	0.5				0.1				mA
		15		10		-				mA
		-				5				mA
Typical Junction Capacitance (Note 2)	C_j	420		280		165				pF
Typical Thermal Resistance	$R_{\theta JC}$	4								°C/W
Operating Junction Temperature Range	T_J	- 65 to + 125				- 65 to + 150				°C
Storage Temperature Range	T_{STG}	- 65 to + 150								°C

Note1: Pulse Test: 300us Pulse Width, 1% Duty cycle

Note2: Measured at 1 MHz and Applied Reverse Voltage of 4.0V D.C.

RATINGS AND CHARACTERISTIC CURVES (SRAF1020 THRU SRAF10150)

FIG.1- FORWARD CURRENT DERATING CURVE

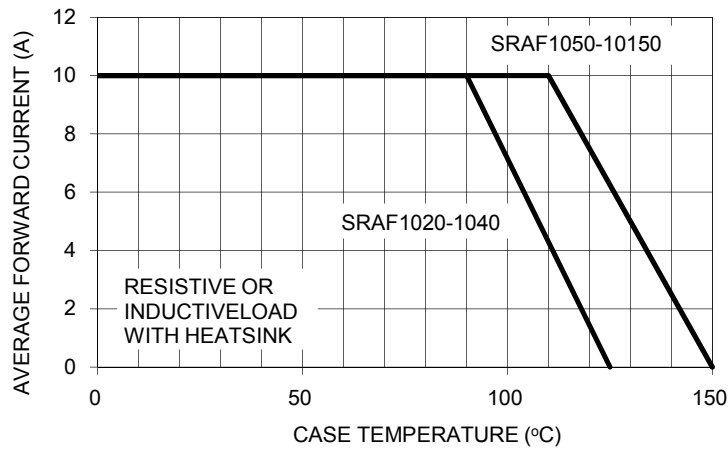

FIG. 2- MAXIMUM NON-REPETITIVE PEAK FORWARD SURGE CURRENT

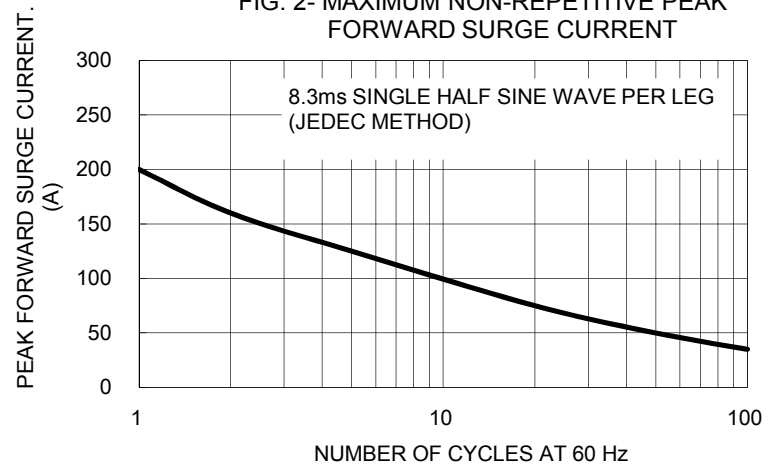

FIG. 3- TYPICAL FORWARD CHARACTERISTICS

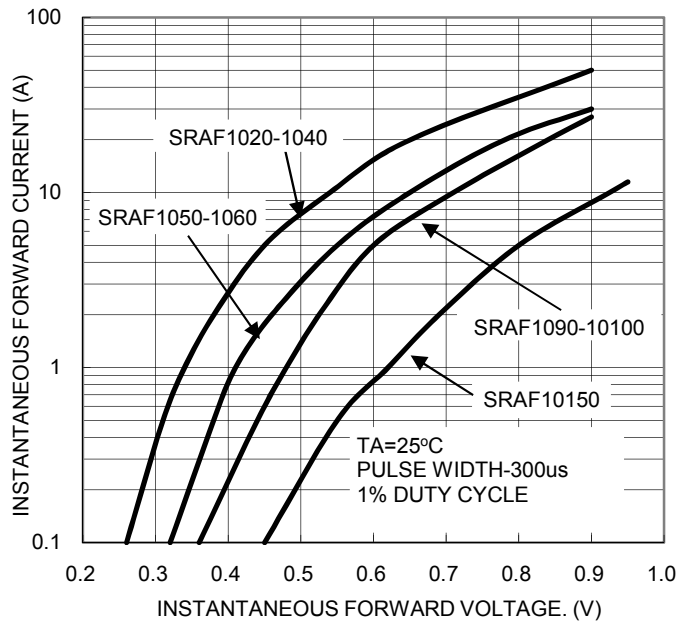

FIG. 4- TYPICAL REVERSE CHARACTERISTICS

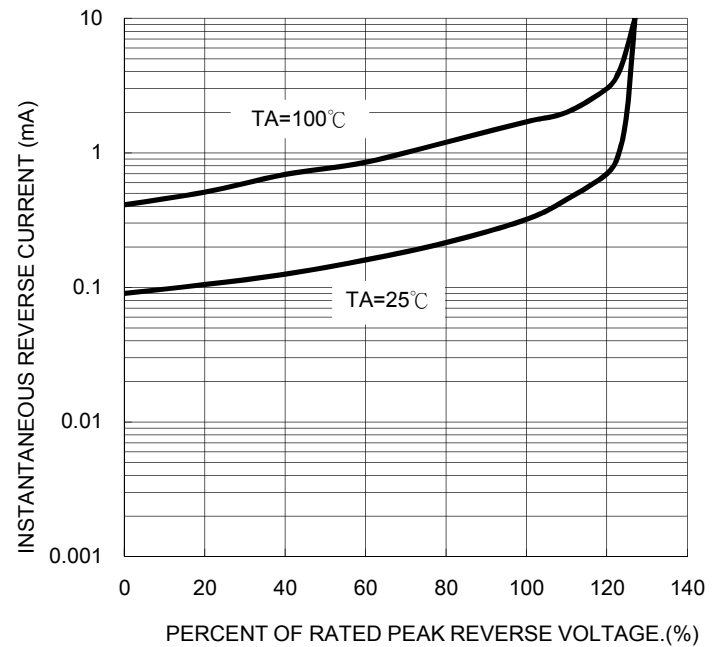

FIG. 5- TYPICAL JUNCTION CAPACITANCE

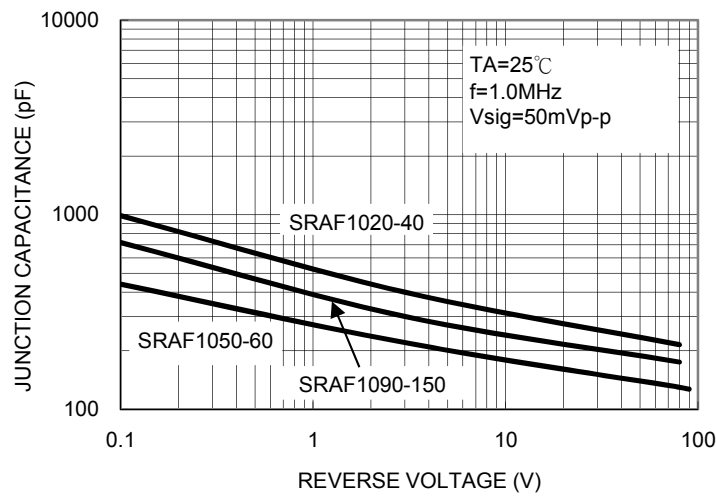
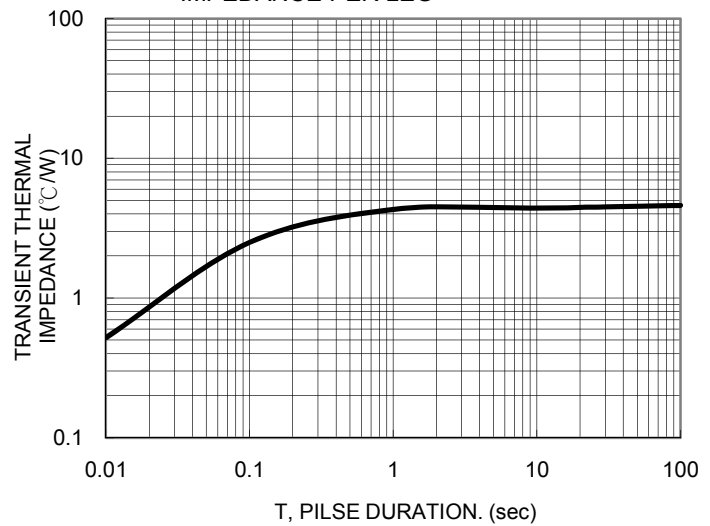

FIG. 6- TYPICAL TRANSIENT THERMAL IMPEDANCE PER LEG



Ordering information

Part No.	Package	BULK Packing	Packing code	Green Compound Packing code
SRAF10xx	ITO-220AC	50 / TUBE	C0	C0G
	ITO-220AC	50 / TUBE	D0	D0G

Note: "xx" is Device Code from "20" thru "150".

Dimensions

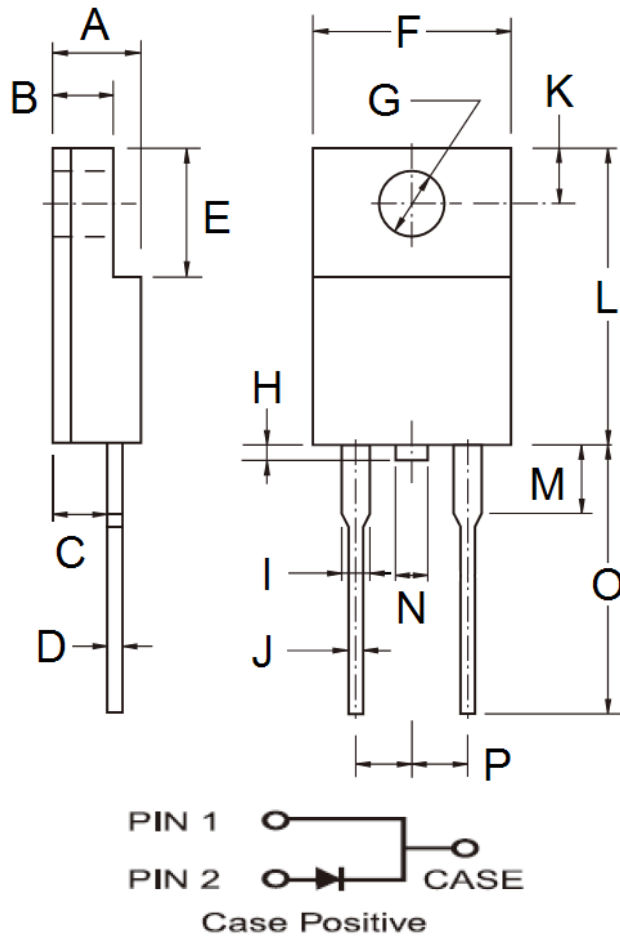

DIM.	Unit(mm)		Unit(inch)	
	Min	Max	Min	Max
A	4.30	4.70	0.169	0.185
B	2.50	3.10	0.098	0.122
C	2.30	2.90	0.091	0.114
D	0.46	0.76	0.018	0.030
E	6.30	6.90	0.248	0.272
F	9.60	10.30	0.378	0.406
G	3.00	3.40	0.118	0.134
H	-	1.60	-	0.063
I	0.95	1.45	0.037	0.057
J	0.50	0.90	0.020	0.035
K	2.40	3.20	0.094	0.126
L	14.80	15.50	0.583	0.610
M	-	4.10	-	0.161
N	-	1.80	-	0.071
O	12.60	13.80	0.496	0.543
P	4.95	5.20	0.195	0.205

Marking Diagram



P/N = Specific Device Code
 G = Green Compound
 YWW = Date Code