



SOP-8



Pin Definition:

1. Source
2. Source
3. Source
4. Gate
- 5, 6, 7, 8. Drain

PRODUCT SUMMARY

V_{DS} (V)	$R_{DS(on)}$ (m Ω)	I_D (A)
-60	155 @ $V_{GS} = -10V$	-3.5
	200 @ $V_{GS} = 4.5V$	-3.1

Features

- Advance Trench Process Technology
- High Density Cell Design for Ultra Low On-resistance

Application

- Load Switch
- PA Switch

Ordering Information

Part No.	Package	Packing
TSM9409CS RF	SOP-8	2.5Kpcs / 13" Reel

Block Diagram

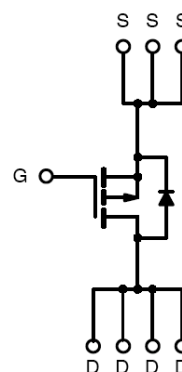

P-Channel MOSFET

Absolute Maximum Rating ($T_a = 25^\circ C$ unless otherwise noted)

Parameter	Symbol	Limit	Unit
Drain-Source Voltage	V_{DS}	-60	V
Gate-Source Voltage	V_{GS}	± 20	V
Continuous Drain Current	I_D	-3.5	A
Pulsed Drain Current	I_{DM}	-30	A
Continuous Source Current (Diode Conduction) ^{a,b}	I_S	-2.5	A
Maximum Power Dissipation	P_D	$T_a = 25^\circ C$	3.0
		$T_a = 70^\circ C$	2.1
Operating Junction Temperature	T_J	+150	$^\circ C$
Operating Junction and Storage Temperature Range	T_J, T_{STG}	- 55 to +150	$^\circ C$

Thermal Performance

Parameter	Symbol	Limit	Unit
Junction to Case Thermal Resistance	$R_{\theta JC}$	30	$^\circ C/W$
Junction to Ambient Thermal Resistance (PCB mounted)	$R_{\theta JA}$	50	$^\circ C/W$

Notes:

- a. Pulse width limited by the Maximum junction temperature
- b. Surface Mounted on FR4 Board, $t \leq 10$ sec.

Electrical Specifications (Ta = 25°C unless otherwise noted)

Parameter	Conditions	Symbol	Min	Typ	Max	Unit
Static						
Drain-Source Breakdown Voltage	$V_{GS} = 0V, I_D = -250\mu A$	BV_{DSS}	-60	--	--	V
Gate Threshold Voltage	$V_{DS} = V_{GS}, I_D = -250\mu A$	$V_{GS(TH)}$	-1.0	--	--	V
Gate Body Leakage	$V_{GS} = \pm 20V, V_{DS} = 0V$	I_{GSS}	--	--	± 100	nA
Zero Gate Voltage Drain Current	$V_{DS} = -60V, V_{GS} = 0V$	I_{DSS}	--	--	-1.0	μA
On-State Drain Current ^a	$V_{DS} = -5V, V_{GS} = -10V$	$I_{D(ON)}$	-20	--	--	A
Drain-Source On-State Resistance ^a	$V_{GS} = -10V, I_D = -3.5A$	$R_{DS(ON)}$	--	125	155	m Ω
	$V_{GS} = -4.5V, I_D = -3.1A$		--	153	200	
Forward Transconductance ^a	$V_{DS} = -15V, I_D = -3.5A$	g_{fs}	--	8	--	S
Diode Forward Voltage	$I_S = -2.5A, V_{GS} = 0V$	V_{SD}	--	-1.25	-1.5	V
Dynamic^b						
Total Gate Charge	$V_{DS} = -15V, I_D = -3.5A,$ $V_{GS} = -10V$	Q_g	--	6	--	nC
Gate-Source Charge		Q_{gs}	--	1.7	--	
Gate-Drain Charge		Q_{gd}	--	1.5	--	
Input Capacitance	$V_{DS} = -30V, V_{GS} = 0V,$ $f = 1.0MHz$	C_{iss}	--	540	--	pF
Output Capacitance		C_{oss}	--	60	--	
Reverse Transfer Capacitance		C_{rss}	--	30	--	
Switching^c						
Turn-On Delay Time	$V_{DD} = -15V, R_L = 15\Omega,$ $I_D = -1A, V_{GEN} = -10V,$ $R_G = 6\Omega$	$t_{d(on)}$	--	7	--	nS
Turn-On Rise Time		t_r	--	9	--	
Turn-Off Delay Time		$t_{d(off)}$	--	19	--	
Turn-Off Fall Time		t_f	--	4	--	

Notes:

- a. pulse test: PW $\leq 300\mu s$, duty cycle $\leq 2\%$
- b. For DESIGN AID ONLY, not subject to production testing.
- b. Switching time is essentially independent of operating temperature.

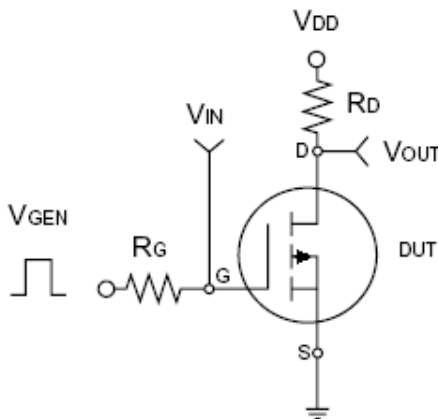

Switching Test Circuit

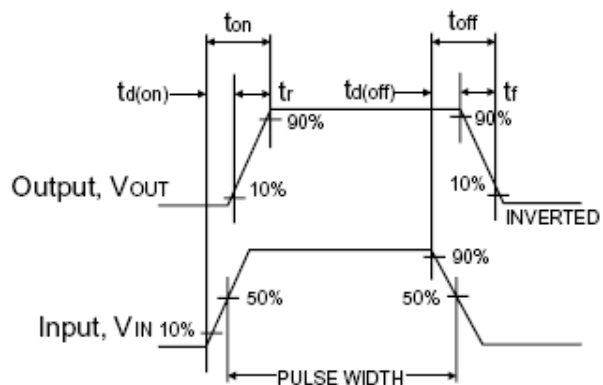

Switchin Waveforms

Electrical Characteristics Curve (Ta = 25°C, unless otherwise noted)

Output Characteristics

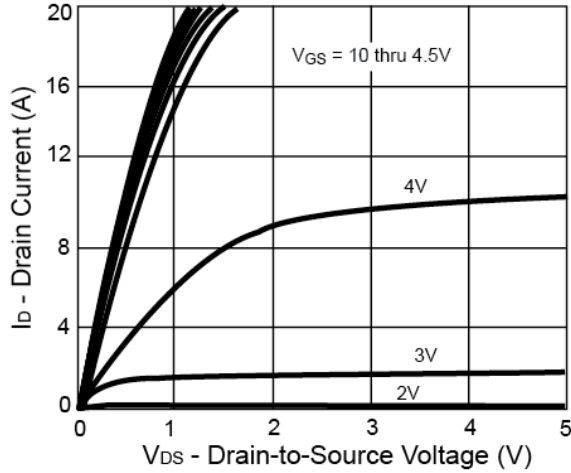

Transfer Characteristics

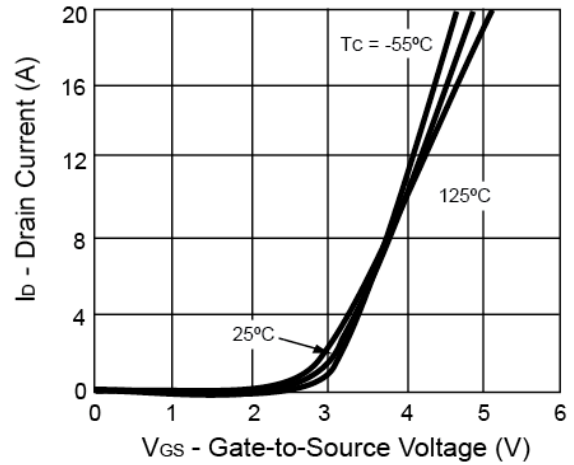

On-Resistance vs. Drain Current

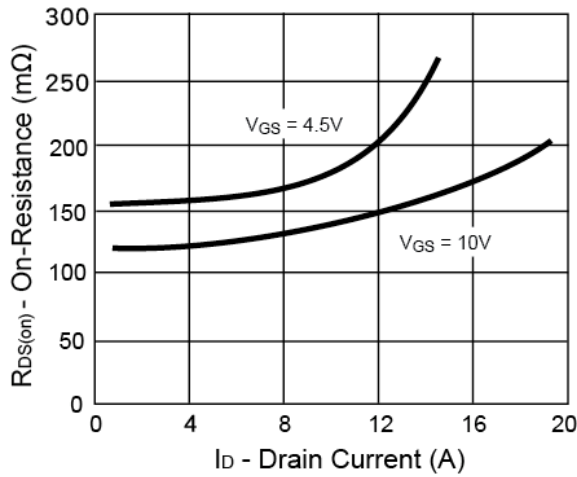

Gate Charge

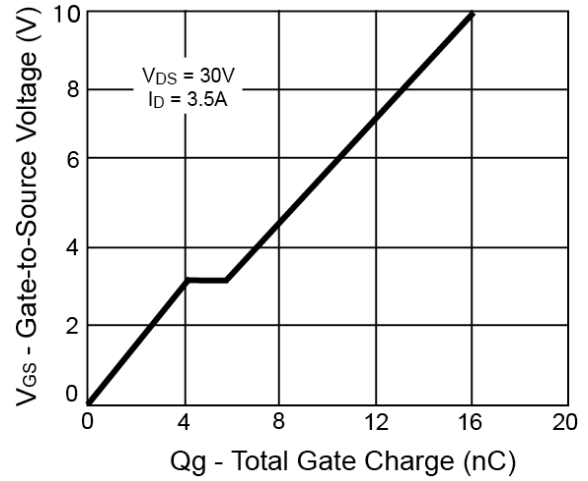

On-Resistance vs. Junction Temperature

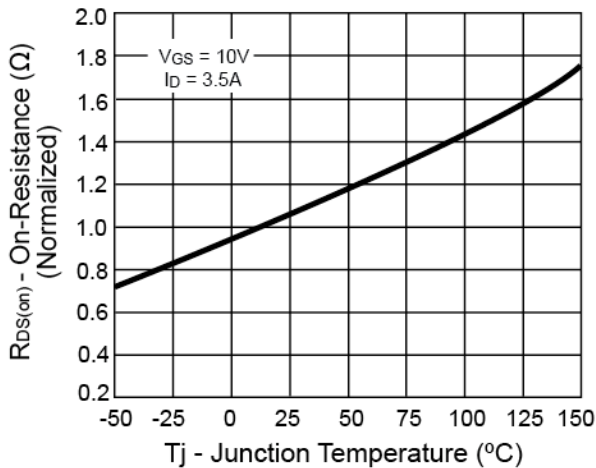

Source-Drain Diode Forward Voltage

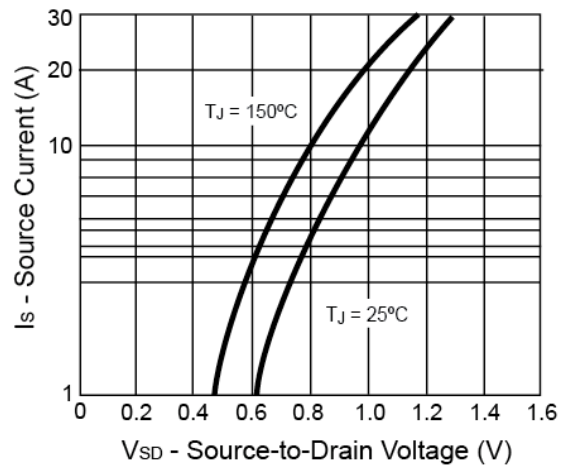

Electrical Characteristics Curve ($T_A = 25^\circ\text{C}$, unless otherwise noted)

On-Resistance vs. Gate-Source Voltage

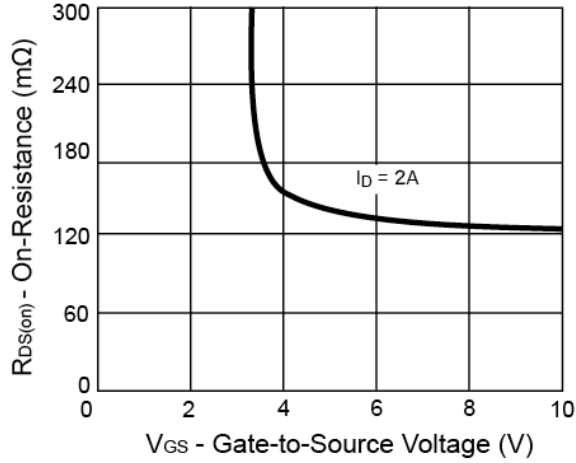

Threshold Voltage

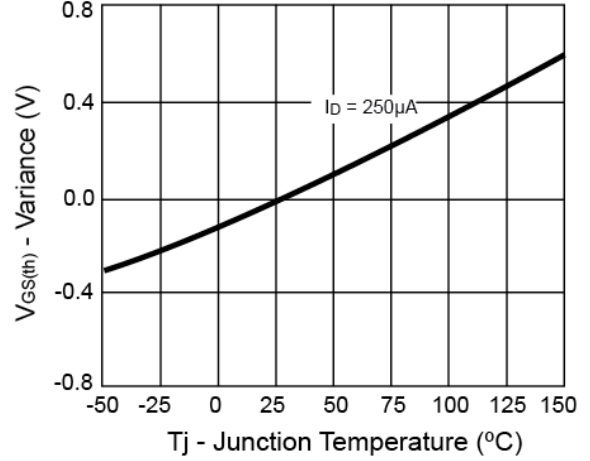

Single Pulse Power

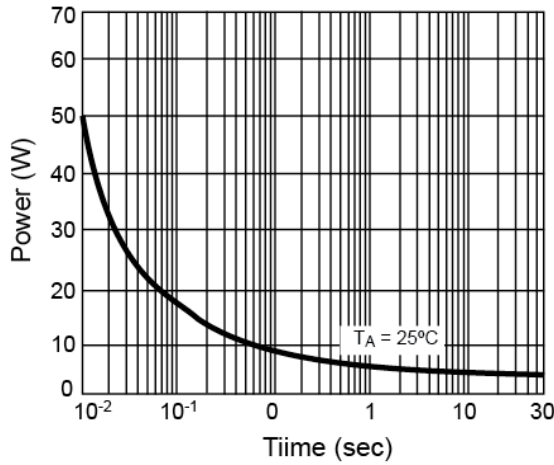

Normalized Thermal Transient Impedance, Junction-to-Ambient

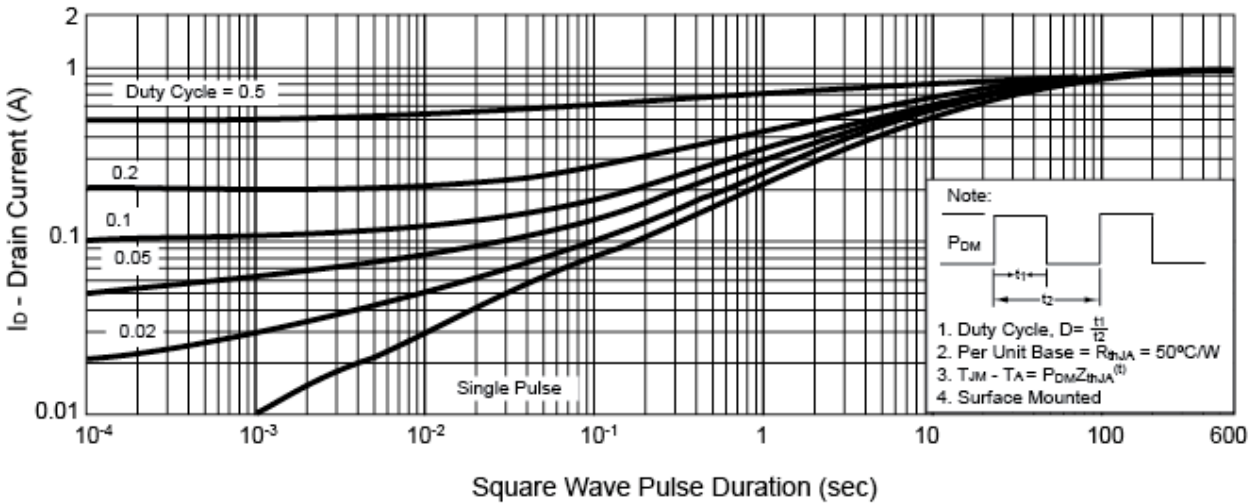

SOP-8 Mechanical Drawing

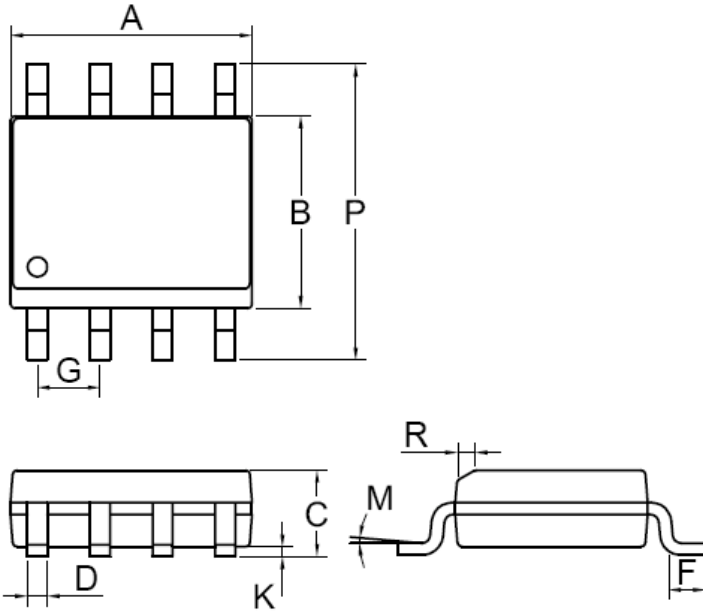

DIM	MILLIMETERS		INCHES	
	MIN	MAX	MIN	MAX.
A	4.80	5.00	0.189	0.196
B	3.80	4.00	0.150	0.157
C	1.35	1.75	0.054	0.068
D	0.35	0.49	0.014	0.019
F	0.40	1.25	0.016	0.049
G	1.27BSC		0.05BSC	
K	0.10	0.25	0.004	0.009
M	0°	7°	0°	7°
P	5.80	6.20	0.229	0.244
R	0.25	0.50	0.010	0.019

Marking Diagram

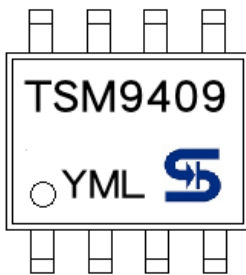

- Y** = Year Code
- M** = Month Code
(A=Jan, B=Feb, C=Mar, D=Apr, E=May, F=Jun, G=Jul, H=Aug, I=Sep, J=Oct, K=Nov, L=Dec)
- L** = Lot Code

Notice

Specifications of the products displayed herein are subject to change without notice. TSC or anyone on its behalf, assumes no responsibility or liability for any errors or inaccuracies.

Information contained herein is intended to provide a product description only. No license, express or implied, to any intellectual property rights is granted by this document. Except as provided in TSC's terms and conditions of sale for such products, TSC assumes no liability whatsoever, and disclaims any express or implied warranty, relating to sale and/or use of TSC products including liability or warranties relating to fitness for a particular purpose, merchantability, or infringement of any patent, copyright, or other intellectual property right.

The products shown herein are not designed for use in medical, life-saving, or life-sustaining applications. Customers using or selling these products for use in such applications do so at their own risk and agree to fully indemnify TSC for any damages resulting from such improper use or sale.