

**ISOTOP<sup>®</sup> Buck chopper  
MOSFET + SiC chopper diode  
Power module**

**$V_{DSS} = 1000V$**   
 **$R_{DSon} = 400m\Omega$  typ @  $T_j = 25^\circ C$**   
 **$I_D = 22A$  @  $T_c = 25^\circ C$**

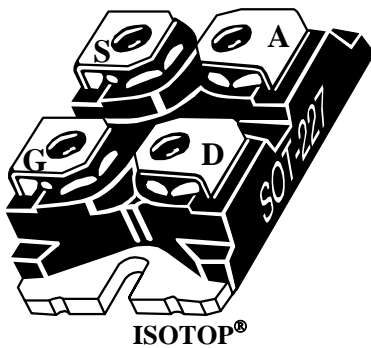
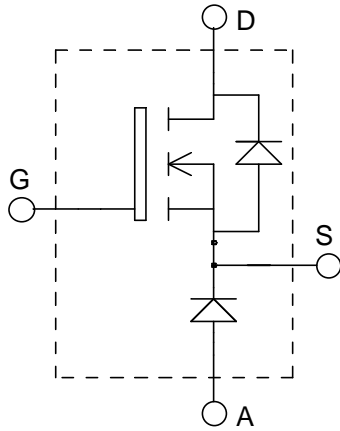

### Application

- AC and DC motor control
- Switched Mode Power Supplies

### Features

- **Power MOS 8<sup>TM</sup> MOSFET**
  - Low  $R_{DSon}$
  - Low input and Miller capacitance
  - Low gate charge
  - Avalanche energy rated
- **SiC Schottky Diode**
  - Zero reverse recovery
  - Zero forward recovery
  - Temperature Independent switching behavior
  - Positive temperature coefficient on VF
- ISOTOP<sup>®</sup> Package (SOT-227)
- Very low stray inductance
- High level of integration

### Benefits

- Outstanding performance at high frequency operation
- Stable temperature behavior
- Very rugged
- Direct mounting to heatsink (isolated package)
- Low junction to case thermal resistance
- Easy paralleling due to positive TC of VCEsat
- RoHS Compliant

### Absolute maximum ratings

Symbol	Parameter	Max ratings	Unit
$V_{DSS}$	Drain - Source Breakdown Voltage	1000	V
$I_D$	Continuous Drain Current	$T_c = 25^\circ C$	22
		$T_c = 80^\circ C$	17
$I_{DM}$	Pulsed Drain current	120	A
$V_{GS}$	Gate - Source Voltage	$\pm 30$	V
$R_{DSon}$	Drain - Source ON Resistance	480	m $\Omega$
$P_D$	Maximum Power Dissipation	$T_c = 25^\circ C$	463
$I_{AR}$	Avalanche current (repetitive and non repetitive)	16	A

**CAUTION:** These Devices are sensitive to Electrostatic Discharge. Proper Handling Procedures Should Be Followed. See application note APT0502 on [www.microsemi.com](http://www.microsemi.com)

All ratings @  $T_j = 25^\circ\text{C}$  unless otherwise specified

**Electrical Characteristics**

Symbol	Characteristic	Test Conditions	Min	Typ	Max	Unit	
$I_{DSS}$	Zero Gate Voltage Drain Current	$V_{DS} = 1000\text{V}$ $V_{GS} = 0\text{V}$	$T_j = 25^\circ\text{C}$			100	$\mu\text{A}$
			$T_j = 125^\circ\text{C}$			500	
$R_{DS(on)}$	Drain – Source on Resistance	$V_{GS} = 10\text{V}, I_D = 16\text{A}$		400	480	$\text{m}\Omega$	
$V_{GS(th)}$	Gate Threshold Voltage	$V_{GS} = V_{DS}, I_D = 2.5\text{mA}$	3	4	5	V	
$I_{GSS}$	Gate – Source Leakage Current	$V_{GS} = \pm 30\text{V}$			$\pm 100$	nA	

**Dynamic Characteristics**

Symbol	Characteristic	Test Conditions	Min	Typ	Max	Unit
$C_{iss}$	Input Capacitance	$V_{GS} = 0\text{V}$ $V_{DS} = 25\text{V}$ $f = 1\text{MHz}$		6800		$\text{pF}$
$C_{oss}$	Output Capacitance			700		
$C_{rss}$	Reverse Transfer Capacitance			92		
$Q_g$	Total gate Charge	$V_{GS} = 10\text{V}$ $V_{Bus} = 500\text{V}$ $I_D = 16\text{A}$		260		nC
$Q_{gs}$	Gate – Source Charge			46		
$Q_{gd}$	Gate – Drain Charge			125		
$T_{d(on)}$	Turn-on Delay Time	<b>Resistive switching @ <math>25^\circ\text{C}</math></b> $V_{GS} = 15\text{V}$ $V_{Bus} = 667\text{V}$ $I_D = 16\text{A}$ $R_G = 2.2\Omega$		39		ns
$T_r$	Rise Time			35		
$T_{d(off)}$	Turn-off Delay Time			130		
$T_f$	Fall Time			33		

**SiC chopper diode ratings and characteristics**

Symbol	Characteristic	Test Conditions	Min	Typ	Max	Unit	
$V_{RRM}$	Maximum Peak Repetitive Reverse Voltage		1200			V	
$I_{RM}$	Maximum Reverse Leakage Current	$V_R = 1200\text{V}$	$T_j = 25^\circ\text{C}$		32	200	$\mu\text{A}$
			$T_j = 175^\circ\text{C}$		56	1000	
$I_F$	DC Forward Current			10		A	
$V_F$	Diode Forward Voltage	$I_F = 10\text{A}$	$T_j = 25^\circ\text{C}$		1.6	1.8	V
			$T_j = 175^\circ\text{C}$		2.3	3	
$Q_C$	Total Capacitive Charge	$I_F = 10\text{A}, V_R = 600\text{V}$ $di/dt = 500\text{A}/\mu\text{s}$		80		nC	
C	Total Capacitance	$f = 1\text{MHz}, V_R = 200\text{V}$		96		$\text{pF}$	
		$f = 1\text{MHz}, V_R = 400\text{V}$		69			

**Thermal and package characteristics**

Symbol	Characteristic	Min	Typ	Max	Unit	
$R_{thJC}$	Junction to Case Thermal Resistance	Mosfet			0.27	$^\circ\text{C}/\text{W}$
		SiC Diode			1.65	
$R_{thJA}$	Junction to Ambient (IGBT & Diode)			20		
$V_{ISOL}$	RMS Isolation Voltage, any terminal to case $t = 1\text{min}, I_{isol} < 1\text{mA}, 50/60\text{Hz}$	2500			V	
$T_J, T_{STG}$	Storage Temperature Range	-40		150	$^\circ\text{C}$	
$T_L$	Max Lead Temp for Soldering: 0.063" from case for 10 sec			300		
Torque	Mounting torque (Mounting = 8-32 or 4mm Machine and terminals = 4mm Machine)			1.5	N.m	
Wt	Package Weight		29.2		g	

## SOT-227 (ISOTOP<sup>®</sup>) Package Outline

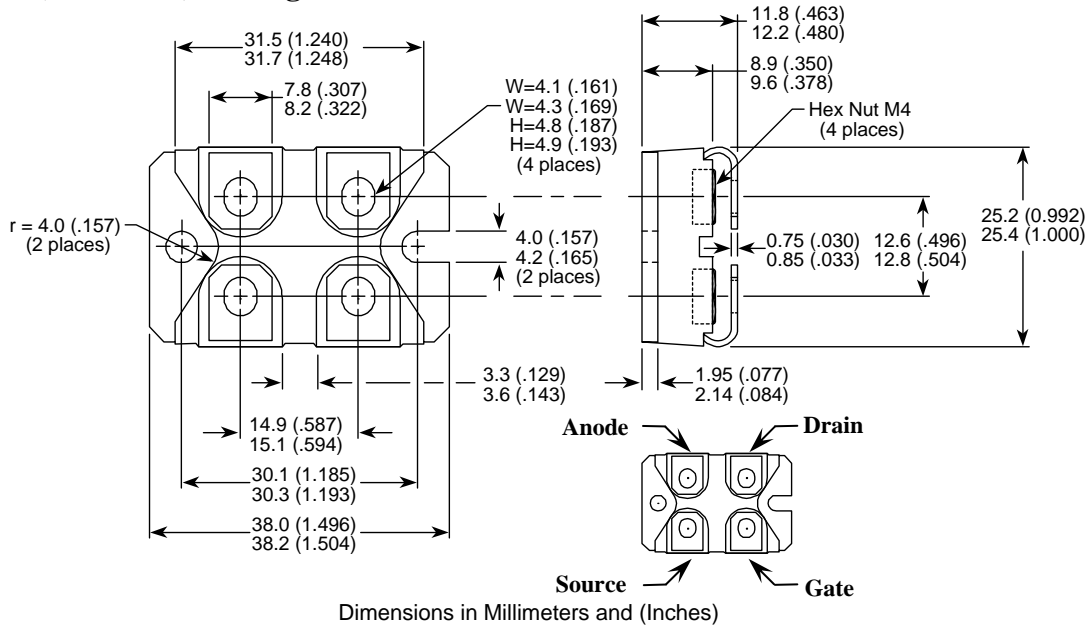

## Typical Mosfet Performance Curve

Maximum Effective Transient Thermal Impedance, Junction to Case vs Pulse Duration

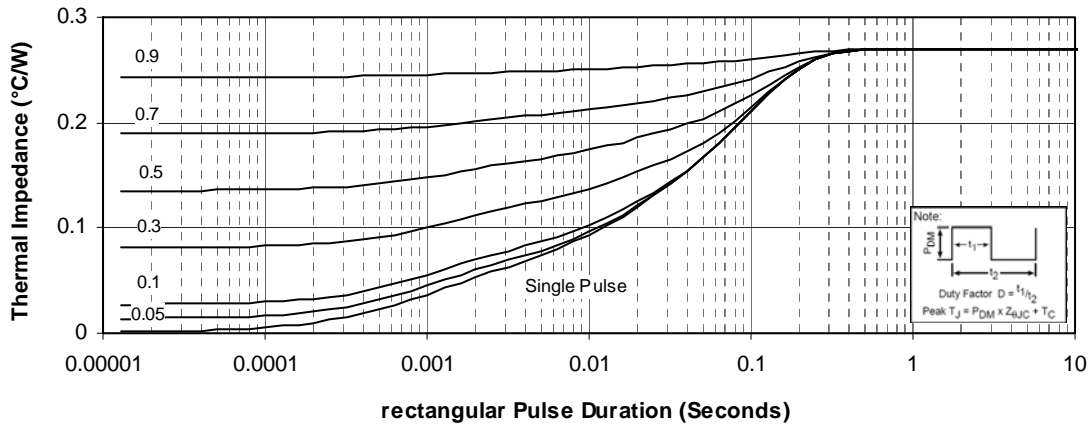

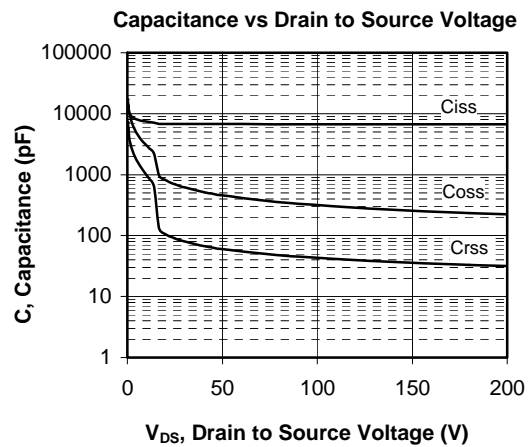
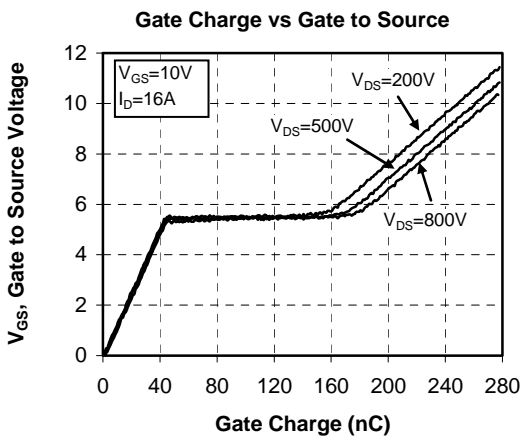
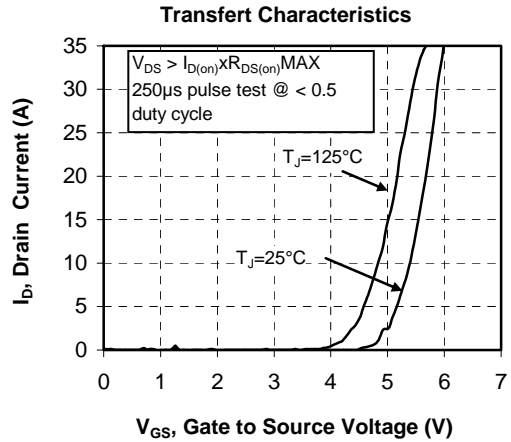
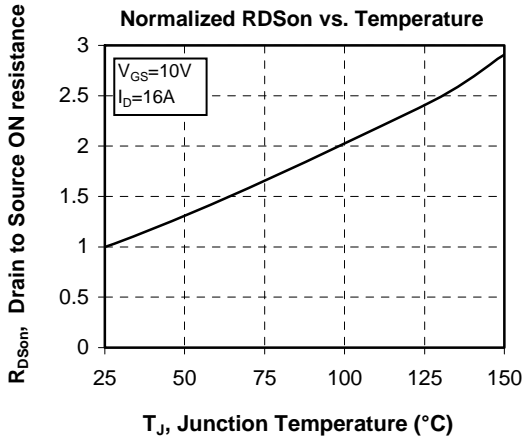
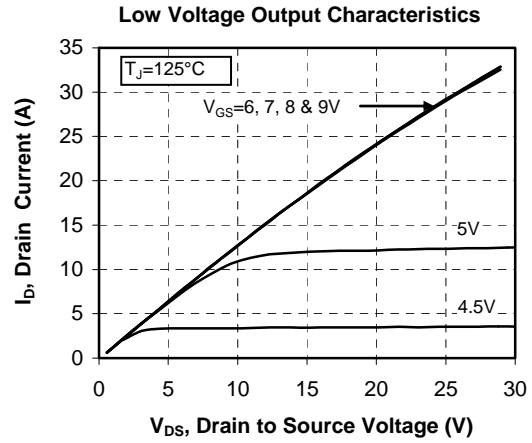
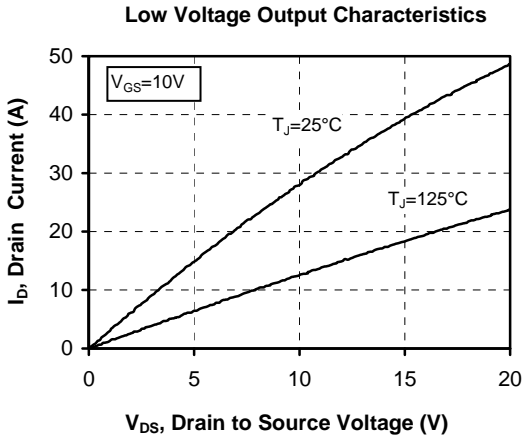

## Typical SiC Diode Performance Curve

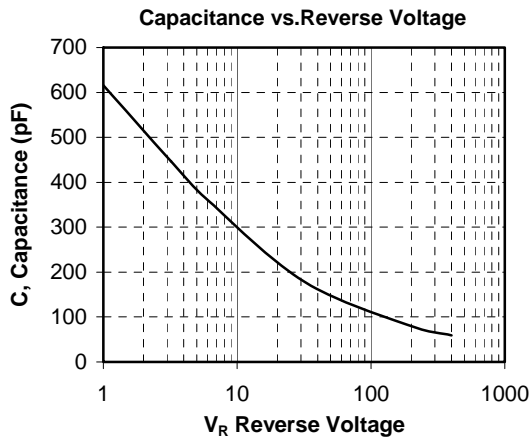
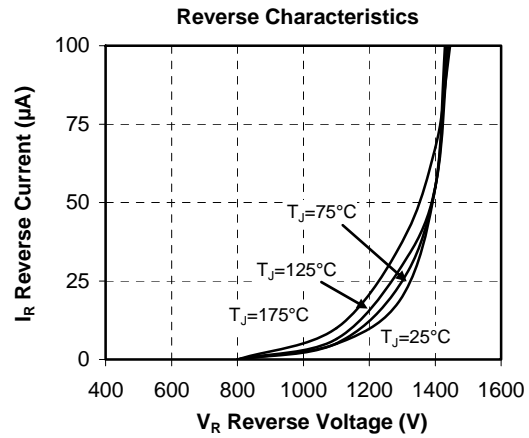
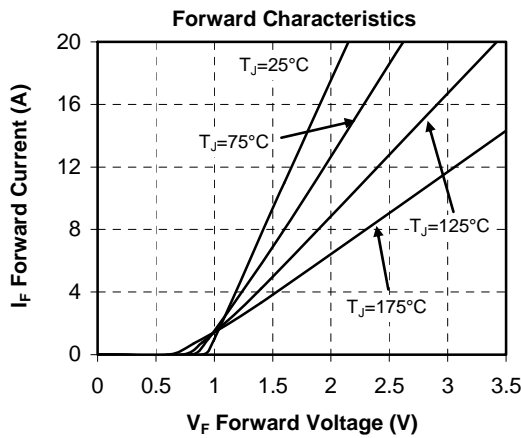
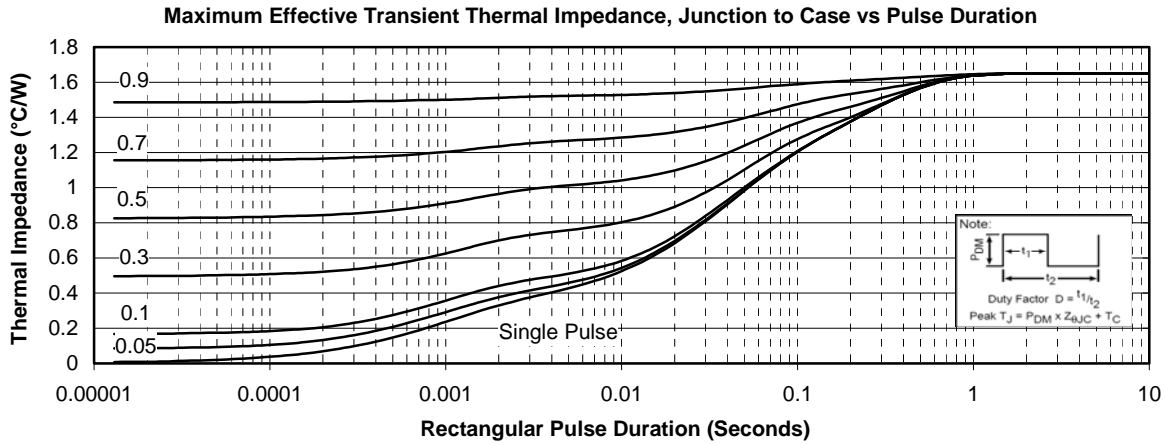

ISOTOP® is a registered trademark of ST Microelectronics NV

Microsemi reserves the right to change, without notice, the specifications and information contained herein

Microsemi's products are covered by one or more of U.S. patents 4,895,810 5,045,903 5,089,434 5,182,234 5,019,522 5,262,336 6,503,786 5,256,583 4,748,103 5,283,202 5,231,474 5,434,095 5,528,058 6,939,743 7,352,045 5,283,201 5,801,417 5,648,283 7,196,634 6,664,594 7,157,886 6,939,743 7,342,262 and foreign patents. U.S and Foreign patents pending. All Rights Reserved.