

*Phase leg  
Series & SiC parallel diodes  
Super Junction  
MOSFET Power Module*

$$V_{DSS} = 600V$$

$$R_{DSon} = 18m\Omega \text{ max @ } T_j = 25^\circ C$$

$$I_D = 143A \text{ @ } T_c = 25^\circ C$$

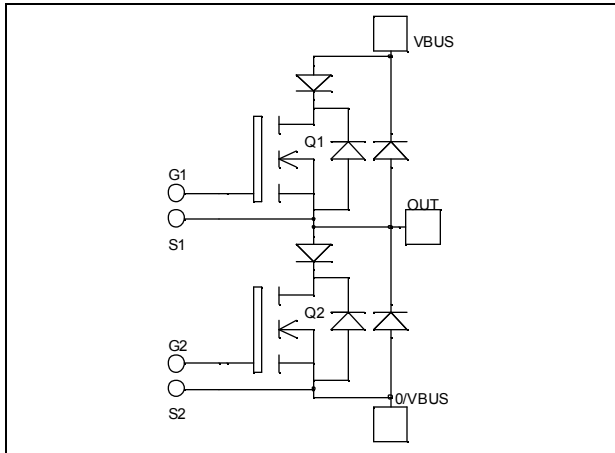

### Application

- Motor control
- Switched Mode Power Supplies
- Uninterruptible Power Supplies

### Features

- **COOLMOS** Power Semiconductors
  - Ultra low  $R_{DSon}$
  - Low Miller capacitance
  - Ultra low gate charge
  - Avalanche energy rated
- **Parallel SiC Schottky Diode**
  - Zero reverse recovery
  - Zero forward recovery
  - Temperature Independent switching behavior
  - Positive temperature coefficient on VF
- Kelvin source for easy drive
- Very low stray inductance
  - Symmetrical design
  - M5 power connectors
- High level of integration

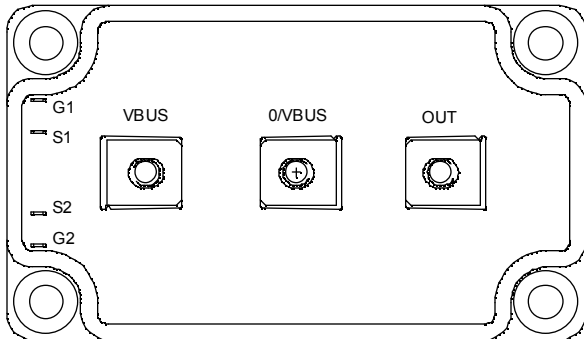

### Benefits

- Outstanding performance at high frequency operation
- Direct mounting to heatsink (isolated package)
- Low junction to case thermal resistance
- Low profile
- RoHS Compliant

### Absolute maximum ratings

Symbol	Parameter	Max ratings	Unit
$V_{DSS}$	Drain - Source Breakdown Voltage	600	V
$I_D$	Continuous Drain Current	$T_c = 25^\circ C$	143
		$T_c = 80^\circ C$	107
$I_{DM}$	Pulsed Drain current	572	A
$V_{GS}$	Gate - Source Voltage	$\pm 30$	V
$R_{DSon}$	Drain - Source ON Resistance	18	$m\Omega$
$P_D$	Maximum Power Dissipation	$T_c = 25^\circ C$	833
$I_{AR}$	Avalanche current (repetitive and non repetitive)	20	A
$E_{AR}$	Repetitive Avalanche Energy	1	mJ
$E_{AS}$	Single Pulse Avalanche Energy	1800	

**CAUTION:** These Devices are sensitive to Electrostatic Discharge. Proper Handling Procedures Should Be Followed. See application note APT0502 on [www.microsemi.com](http://www.microsemi.com)

All ratings @  $T_j = 25^\circ\text{C}$  unless otherwise specified

**Electrical Characteristics**

Symbol	Characteristic	Test Conditions	Min	Typ	Max	Unit
$I_{DSS}$	Zero Gate Voltage Drain Current	$V_{GS} = 0\text{V}, V_{DS} = 600\text{V}$			100	$\mu\text{A}$
		$V_{GS} = 0\text{V}, V_{DS} = 600\text{V}$	$T_j = 25^\circ\text{C}$			
$R_{DS(on)}$	Drain – Source on Resistance	$V_{GS} = 10\text{V}, I_D = 71.5\text{A}$			18	$\text{m}\Omega$
$V_{GS(th)}$	Gate Threshold Voltage	$V_{GS} = V_{DS}, I_D = 4\text{mA}$	2.1	3	3.9	V
$I_{GSS}$	Gate – Source Leakage Current	$V_{GS} = \pm 20\text{V}, V_{DS} = 0\text{V}$			$\pm 200$	nA

**Dynamic Characteristics**

Symbol	Characteristic	Test Conditions	Min	Typ	Max	Unit
$C_{iss}$	Input Capacitance	$V_{GS} = 0\text{V}$		28		nF
$C_{oss}$	Output Capacitance	$V_{DS} = 25\text{V}$		10.2		
$C_{rss}$	Reverse Transfer Capacitance	$f = 1\text{MHz}$		0.85		
$Q_g$	Total gate Charge	$V_{GS} = 10\text{V}$		1036		nC
$Q_{gs}$	Gate – Source Charge	$V_{Bus} = 300\text{V}$		116		
$Q_{gd}$	Gate – Drain Charge	$I_D = 143\text{A}$		444		
$T_{d(on)}$	Turn-on Delay Time	<b>Inductive switching @ <math>125^\circ\text{C}</math></b> $V_{GS} = 15\text{V}$ $V_{Bus} = 400\text{V}$ $I_D = 143\text{A}$ $R_G = 1.2\Omega$		21		ns
$T_r$	Rise Time			30		
$T_{d(off)}$	Turn-off Delay Time			283		
$T_f$	Fall Time			84		
$E_{on}$	Turn-on Switching Energy	<b>Inductive switching @ <math>25^\circ\text{C}</math></b> $V_{GS} = 15\text{V}, V_{Bus} = 400\text{V}$ $I_D = 143\text{A}, R_G = 1.2\Omega$		1608		$\mu\text{J}$
$E_{off}$	Turn-off Switching Energy			3920		
$E_{on}$	Turn-on Switching Energy	<b>Inductive switching @ <math>125^\circ\text{C}</math></b> $V_{GS} = 15\text{V}, V_{Bus} = 400\text{V}$ $I_D = 143\text{A}, R_G = 1.2\Omega$		2630		$\mu\text{J}$
$E_{off}$	Turn-off Switching Energy			4824		

**Series diode ratings and characteristics**

Symbol	Characteristic	Test Conditions	Min	Typ	Max	Unit
$V_{RRM}$	Maximum Peak Repetitive Reverse Voltage		200			V
$I_{RM}$	Maximum Reverse Leakage Current	$V_R = 200\text{V}$	$T_j = 25^\circ\text{C}$		350	$\mu\text{A}$
			$T_j = 125^\circ\text{C}$		600	
$I_F$	DC Forward Current			120		A
$V_F$	Diode Forward Voltage	$I_F = 120\text{A}$		1.1	1.15	V
		$I_F = 240\text{A}$		1.4		
		$I_F = 120\text{A}$	$T_j = 125^\circ\text{C}$	0.9		
$t_{rr}$	Reverse Recovery Time	$I_F = 120\text{A}$ $V_R = 133\text{V}$ $di/dt = 400\text{A}/\mu\text{s}$	$T_j = 25^\circ\text{C}$	31		ns
			$T_j = 125^\circ\text{C}$	60		
$Q_{rr}$	Reverse Recovery Charge	$I_F = 120\text{A}$ $V_R = 133\text{V}$ $di/dt = 400\text{A}/\mu\text{s}$	$T_j = 25^\circ\text{C}$	120		nC
			$T_j = 125^\circ\text{C}$	500		

## Parallel diode ratings and characteristics

Symbol	Characteristic	Test Conditions		Min	Typ	Max	Unit
$V_{RRM}$	Maximum Peak Repetitive Reverse Voltage			600			V
$I_{RM}$	Maximum Reverse Leakage Current	$V_R=600V$	$T_j = 25^\circ C$		400	1600	$\mu A$
			$T_j = 175^\circ C$		800	8000	
$I_F$	DC Forward Current		$T_c = 125^\circ C$		80		A
$V_F$	Diode Forward Voltage	$I_F = 80A$	$T_j = 25^\circ C$		1.6	1.8	V
			$T_j = 175^\circ C$		2.0	2.4	
$Q_C$	Total Capacitive Charge	$I_F = 80A, V_R = 300V$ $di/dt = 2000A/\mu s$			112		nC
Q	Total Capacitance	$f = 1MHz, V_R = 200V$			520		pF
		$f = 1MHz, V_R = 400V$			400		

## Thermal and package characteristics

Symbol	Characteristic			Min	Typ	Max	Unit
$R_{thJC}$	Junction to Case Thermal Resistance	Transistor				0.15	$^\circ C/W$
		Series diode				0.46	
		Parallel diode				0.35	
$V_{ISOL}$	RMS Isolation Voltage, any terminal to case $t=1$ min, $I_{isol} < 1mA$ , 50/60Hz			2500			V
$T_J$	Operating junction temperature range			-40		150	$^\circ C$
$T_{STG}$	Storage Temperature Range			-40		125	
$T_C$	Operating Case Temperature			-40		100	
Torque	Mounting torque	To heatsink	M6	3		5	N.m
		For terminals	M5	2		3.5	
Wt	Package Weight					280	g

## SP6 Package outline (dimensions in mm)

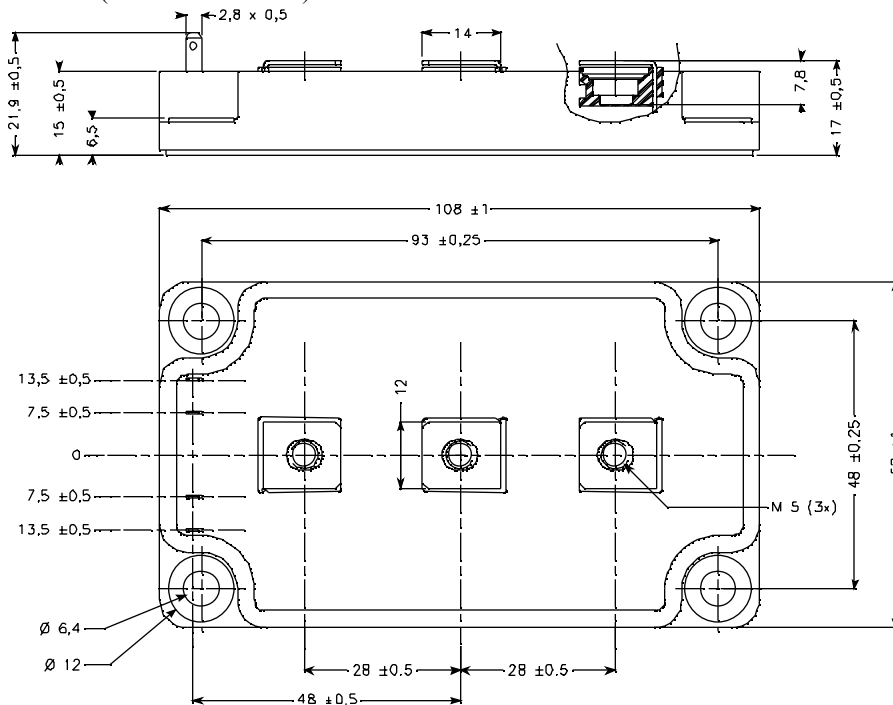

See application note APT0601 - Mounting Instructions for SP6 Power Modules on [www.microsemi.com](http://www.microsemi.com)

## Typical CoolMOS Performance Curve

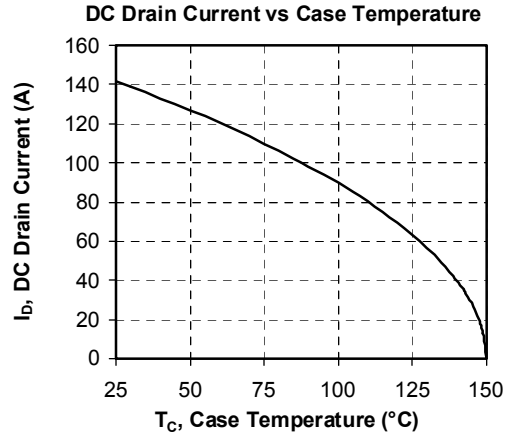
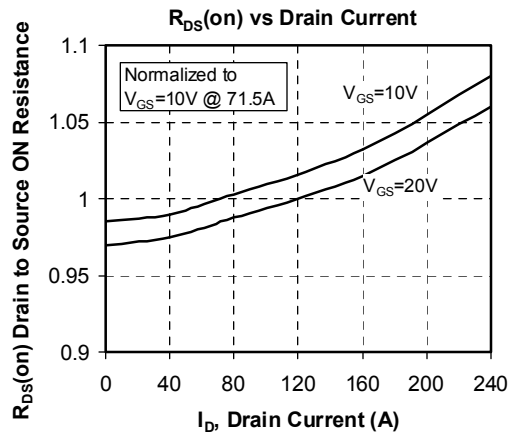
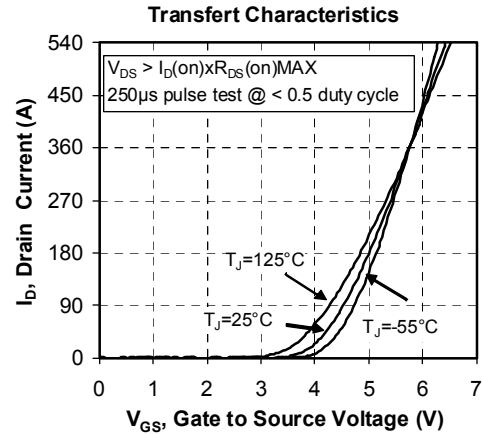
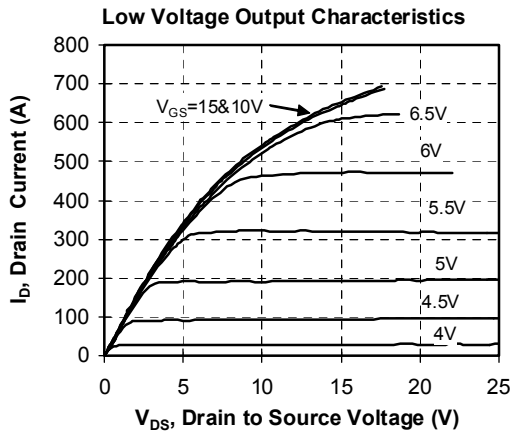
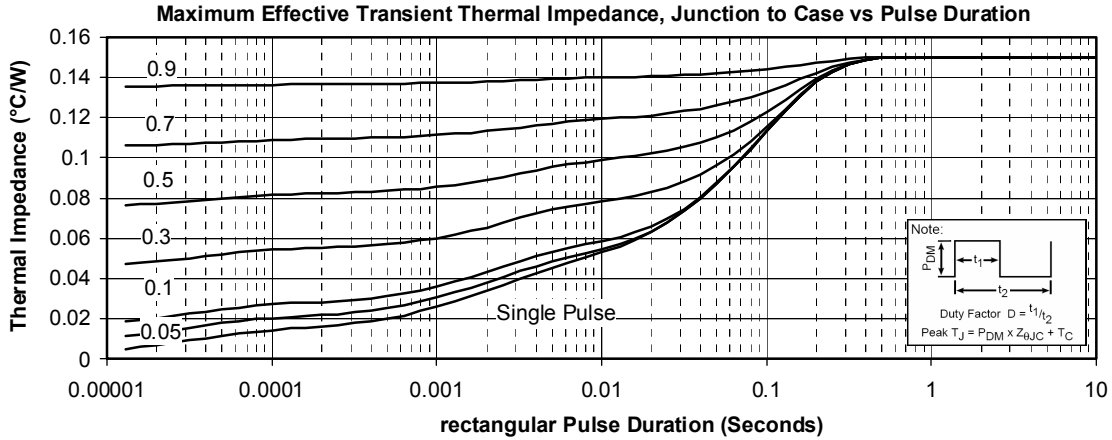

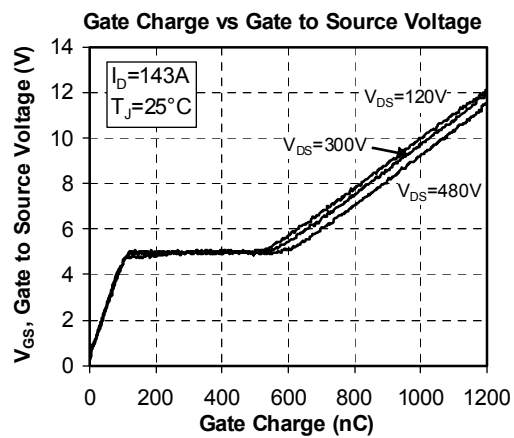
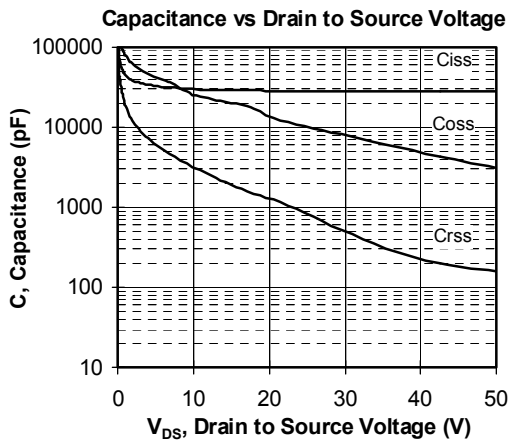
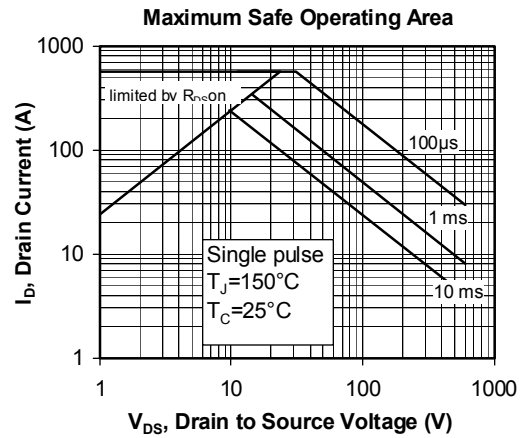
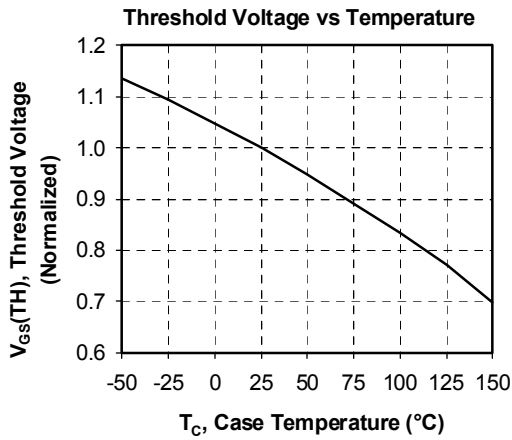
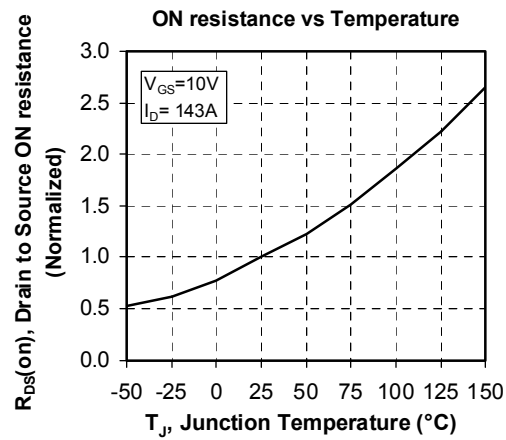
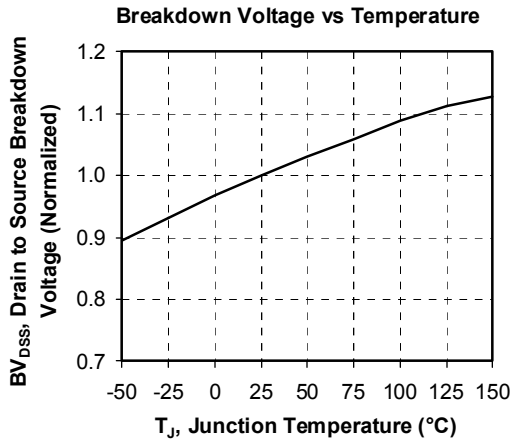

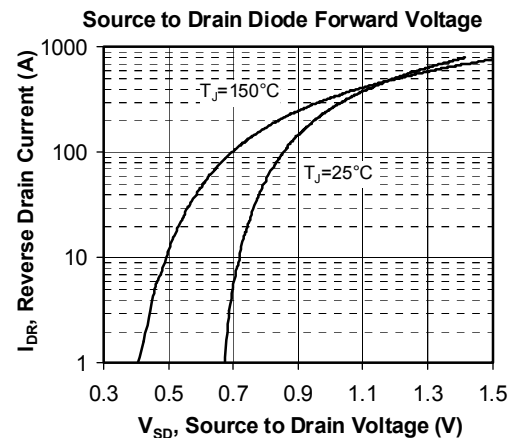
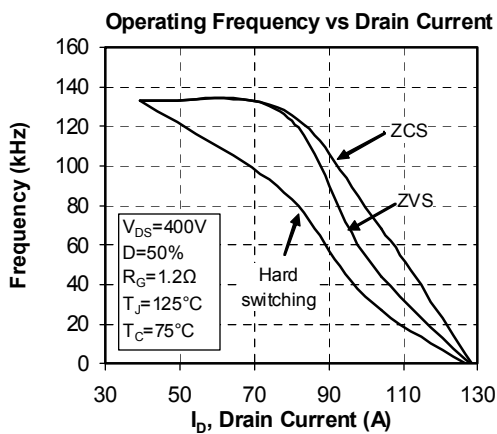
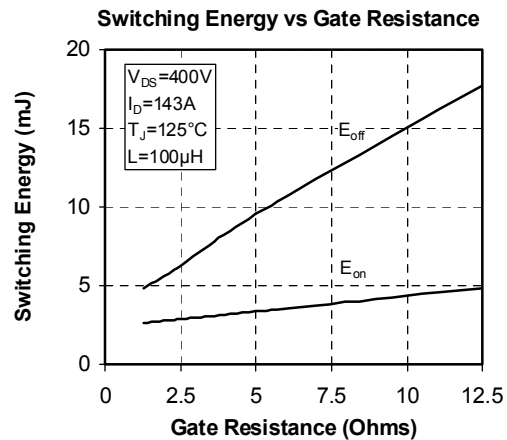
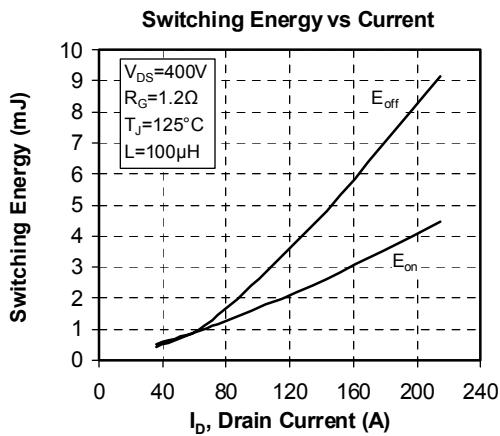
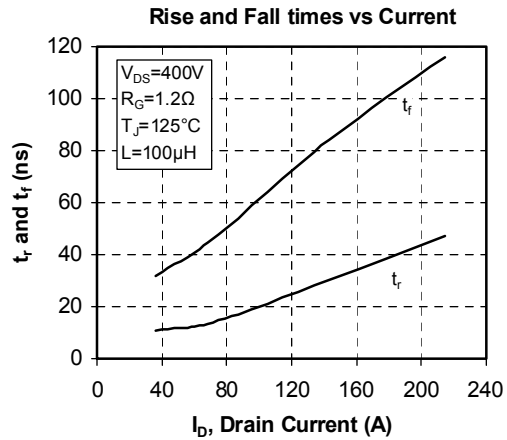
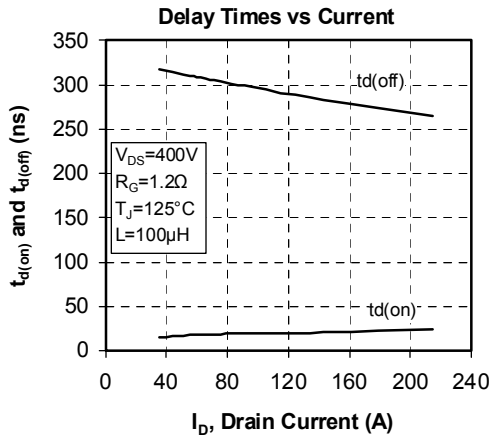

## Typical SiC Diode Performance Curve

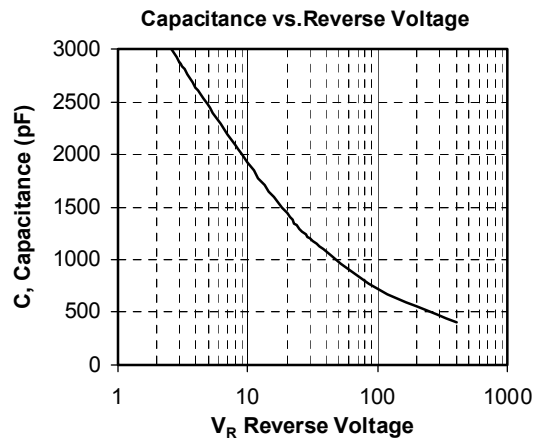
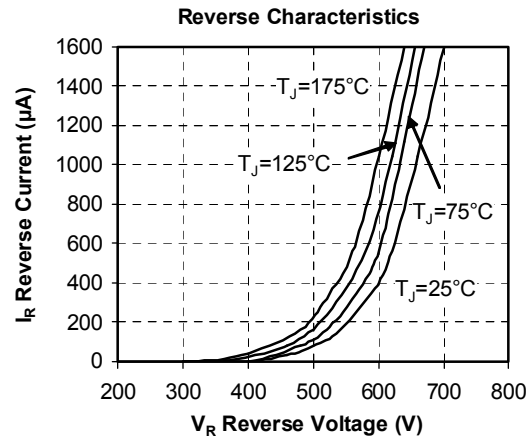
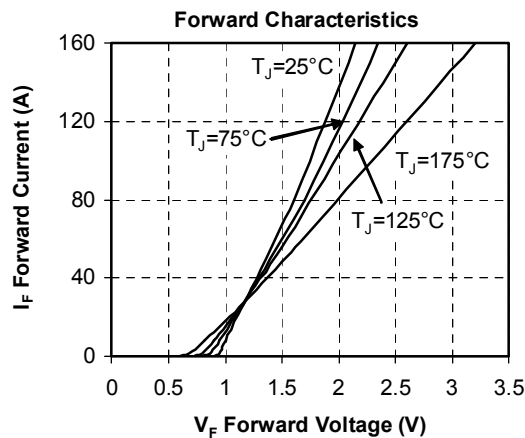
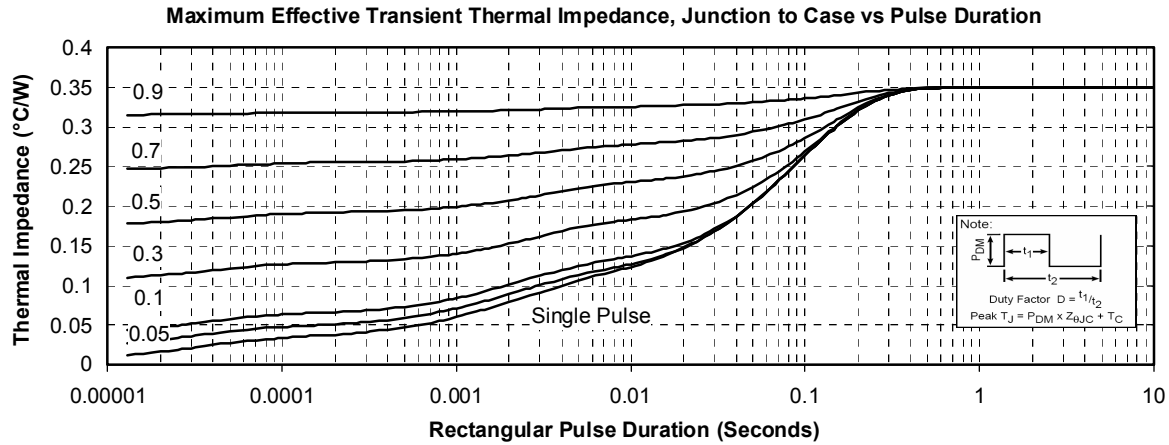

“COOLMOS™” comprise a new family of transistors developed by Infineon Technologies AG. “COOLMOS” is a trademark of Infineon Technologies AG”.

Microsemi reserves the right to change, without notice, the specifications and information contained herein

Microsemi's products are covered by one or more of U.S. patents 4,895,810 5,045,903 5,089,434 5,182,234 5,019,522 5,262,336 6,503,786 5,256,583 4,748,103 5,283,202 5,231,474 5,434,095 5,528,058 and foreign patents. U.S. and Foreign patents pending. All Rights Reserved.