

## POWER MOS 7® FREDFET

Power MOS 7® is a new generation of low loss, high voltage, N-Channel enhancement mode power MOSFETS. Both conduction and switching losses are addressed with Power MOS 7® by significantly lowering  $R_{DS(ON)}$  and  $Q_g$ . Power MOS 7® combines lower conduction and switching losses along with exceptionally fast switching speeds inherent with APT's patented metal gate structure.

- Lower Input Capacitance
- Lower Miller Capacitance
- Lower Gate Charge,  $Q_g$
- Increased Power Dissipation
- Easier To Drive
- TO-247 or Surface Mount D<sup>3</sup>PAK Package
- **FAST RECOVERY BODY DIODE**

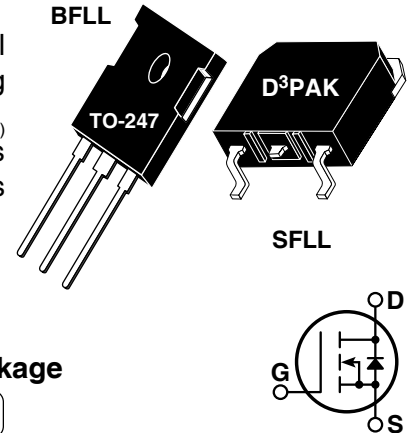

### MAXIMUM RATINGS

All Ratings:  $T_C = 25^\circ\text{C}$  unless otherwise specified.

| Symbol         | Parameter  | APT20M36BFL_SFL | UNIT                |
|----------------|--|-----------------|---------------------|
| $V_{DSS}$      | Drain-Source Voltage   | 200             | Volts               |
| $I_D$          | Continuous Drain Current @ $T_C = 25^\circ\text{C}$            | 65              | Amps                |
| $I_{DM}$       | Pulsed Drain Current <sup>①</sup>                              | 260             |                     |
| $V_{GS}$       | Gate-Source Voltage Continuous                                 | $\pm 30$        | Volts               |
| $V_{GSM}$      | Gate-Source Voltage Transient                                  | $\pm 40$        |                     |
| $P_D$          | Total Power Dissipation @ $T_C = 25^\circ\text{C}$             | 329             | Watts               |
|                | Linear Derating Factor   | 2.63            | W/ $^\circ\text{C}$ |
| $T_J, T_{STG}$ | Operating and Storage Junction Temperature Range               | -55 to 150      | $^\circ\text{C}$    |
| $T_L$          | Lead Temperature: 0.063" from Case for 10 Sec.                 | 300             |                     |
| $I_{AR}$       | Avalanche Current <sup>①</sup> (Repetitive and Non-Repetitive) | 65              | Amps                |
| $E_{AR}$       | Repetitive Avalanche Energy <sup>①</sup>                       | 30              | mJ                  |
| $E_{AS}$       | Single Pulse Avalanche Energy <sup>④</sup>                     | 1300            |                     |

### STATIC ELECTRICAL CHARACTERISTICS

| Symbol       | Characteristic / Test Conditions  | MIN | TYP | MAX       | UNIT          |
|--------------|---|-----|-----|-----------|---------------|
| $BV_{DSS}$   | Drain-Source Breakdown Voltage ( $V_{GS} = 0V, I_D = 250\mu\text{A}$ )                    | 200 |     |           | Volts         |
| $R_{DS(on)}$ | Drain-Source On-State Resistance <sup>②</sup> ( $V_{GS} = 10V, I_D = 32.5A$ )             |     |     | 0.036     | Ohms          |
| $I_{DSS}$    | Zero Gate Voltage Drain Current ( $V_{DS} = 200V, V_{GS} = 0V$ )                          |     |     | 250       | $\mu\text{A}$ |
|              | Zero Gate Voltage Drain Current ( $V_{DS} = 160V, V_{GS} = 0V, T_C = 125^\circ\text{C}$ ) |     |     | 1000      |               |
| $I_{GSS}$    | Gate-Source Leakage Current ( $V_{GS} = \pm 30V, V_{DS} = 0V$ )                           |     |     | $\pm 100$ | nA            |
| $V_{GS(th)}$ | Gate Threshold Voltage ( $V_{DS} = V_{GS}, I_D = 1mA$ )                                   | 3   |     | 5         | Volts         |

 **CAUTION:** These Devices are Sensitive to Electrostatic Discharge. Proper Handling Procedures Should Be Followed.

APT Website - <http://www.advancedpower.com>

**DYNAMIC CHARACTERISTICS**

**APT20M36BFL S\_FLL**

| Symbol       | Characteristic               | Test Conditions  | MIN | TYP  | MAX | UNIT |
|--------------|------------------------------|--|-----|------|-----|------|
| $C_{iss}$    | Input Capacitance            | $V_{GS} = 0V$<br>$V_{DS} = 25V$<br>$f = 1\text{ MHz}$  |     | 3080 |     | pF   |
| $C_{oss}$    | Output Capacitance           |  |     | 990  |     |      |
| $C_{rss}$    | Reverse Transfer Capacitance |  |     | 70   |     |      |
| $Q_g$        | Total Gate Charge ③          | $V_{GS} = 10V$<br>$V_{DD} = 100V$<br>$I_D = 65A @ 25^\circ C$  |     | 60   |     | nC   |
| $Q_{gs}$     | Gate-Source Charge           |  |     | 24   |     |      |
| $Q_{gd}$     | Gate-Drain ("Miller") Charge |  |     | 26   |     |      |
| $t_{d(on)}$  | Turn-on Delay Time           | <b>RESISTIVE SWITCHING</b><br>$V_{GS} = 15V$<br>$V_{DD} = 100V$<br>$I_D = 65A @ 25^\circ C$<br>$R_G = 1.6\Omega$ |     | 9    |     | ns   |
| $t_r$        | Rise Time                    |  |     | 37   |     |      |
| $t_{d(off)}$ | Turn-off Delay Time          |  |     | 16   |     |      |
| $t_f$        | Fall Time                    |  |     | 30   |     |      |
| $E_{on}$     | Turn-on Switching Energy ⑥   | <b>INDUCTIVE SWITCHING @ 25°C</b><br>$V_{DD} = 133V, V_{GS} = 15V$<br>$I_D = 65A, R_G = 5\Omega$                 |     | 490  |     | μJ   |
| $E_{off}$    | Turn-off Switching Energy    |  |     | 300  |     |      |
| $E_{on}$     | Turn-on Switching Energy ⑥   | <b>INDUCTIVE SWITCHING @ 125°C</b><br>$V_{DD} = 133V, V_{GS} = 15V$<br>$I_D = 65A, R_G = 5\Omega$                |     | 600  |     | μJ   |
| $E_{off}$    | Turn-off Switching Energy    |  |     | 315  |     |      |

**SOURCE-DRAIN DIODE RATINGS AND CHARACTERISTICS**

| Symbol    | Characteristic / Test Conditions                                | MIN                 | TYP | MAX | UNIT  |
|-----------|---|---------------------|-----|-----|-------|
| $I_S$     | Continuous Source Current (Body Diode)                          |                     |     | 65  | Amps  |
| $I_{SM}$  | Pulsed Source Current ① (Body Diode)                            |                     |     | 260 | Amps  |
| $V_{SD}$  | Diode Forward Voltage ② ( $V_{GS} = 0V, I_S = -65A$ )           |                     |     | 1.3 | Volts |
| $dv/dt$   | Peak Diode Recovery $dv/dt$ ⑤                                   |                     |     | 8   | V/ns  |
| $t_{rr}$  | Reverse Recovery Time<br>( $I_S = -65A, di/dt = 100A/\mu s$ )   | $T_j = 25^\circ C$  |     | 200 | ns    |
|           |   | $T_j = 125^\circ C$ |     | 300 |       |
| $Q_{rr}$  | Reverse Recovery Charge<br>( $I_S = -65A, di/dt = 100A/\mu s$ ) | $T_j = 25^\circ C$  |     | 0.7 | μC    |
|           |   | $T_j = 125^\circ C$ |     | 2.4 |       |
| $I_{RRM}$ | Peak Recovery Current<br>( $I_S = -65A, di/dt = 100A/\mu s$ )   | $T_j = 25^\circ C$  |     | 10  | Amps  |
|           |   | $T_j = 125^\circ C$ |     | 18  |       |

**THERMAL CHARACTERISTICS**

| Symbol          | Characteristic      | MIN | TYP | MAX  | UNIT |
|-----------------|---------------------|-----|-----|------|------|
| $R_{\theta JC}$ | Junction to Case    |     |     | 0.38 | °C/W |
| $R_{\theta JA}$ | Junction to Ambient |     |     | 40   |      |

① Repetitive Rating: Pulse width limited by maximum junction temperature

② Pulse Test: Pulse width < 380 μs, Duty Cycle < 2%

③ See MIL-STD-750 Method 3471

④ Starting  $T_j = +25^\circ C, L = 0.62mH, R_G = 25\Omega, \text{Peak } I_L = 65A$

⑤  $dv/dt$  numbers reflect the limitations of the test circuit rather than the device itself.  $I_S \leq -I_D 65A, di/dt \leq 700A/\mu s, v_R \leq 200V, T_j \leq 150^\circ C$

⑥  $E_{on}$  includes diode reverse recovery. See figures 18, 20.

APT Reserves the right to change, without notice, the specifications and information contained herein.

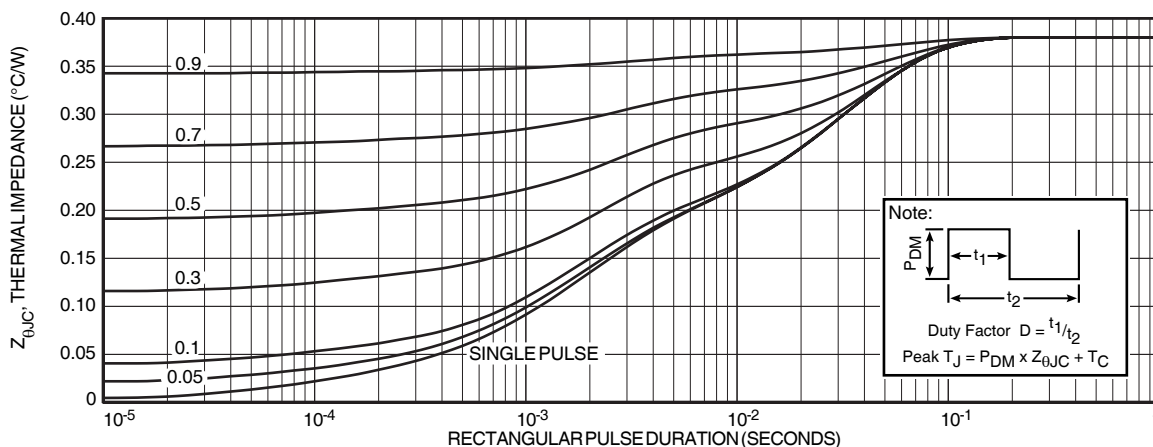

FIGURE 1, MAXIMUM EFFECTIVE TRANSIENT THERMAL IMPEDANCE, JUNCTION-TO-CASE vs PULSE DURATION

Typical Performance Curves

APT20M36 BFLI\_SFLI

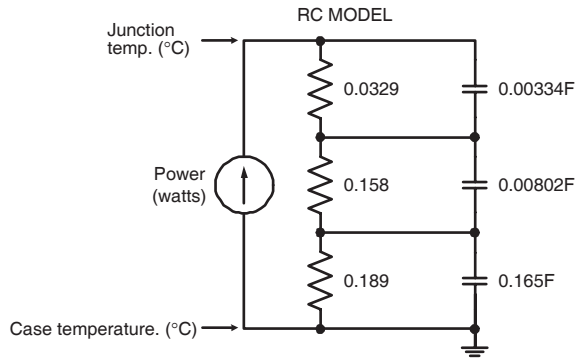

FIGURE 2, TRANSIENT THERMAL IMPEDANCE MODEL

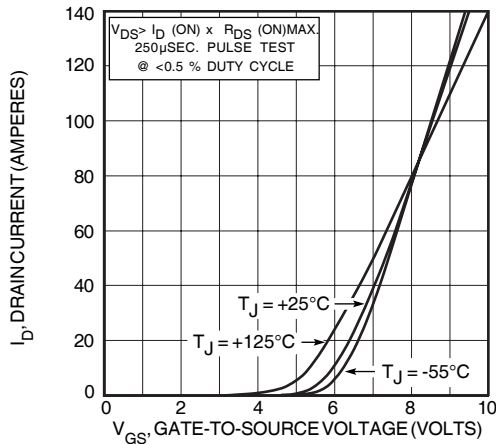

FIGURE 4, TRANSFER CHARACTERISTICS

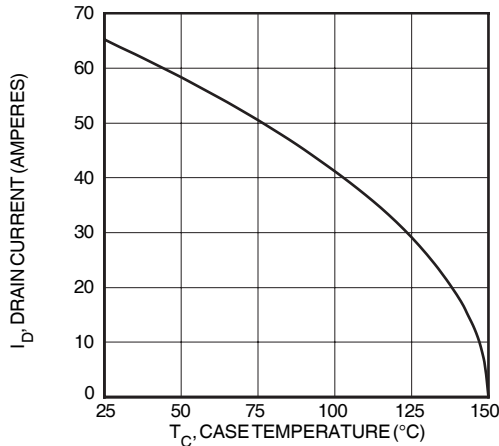

FIGURE 6, MAXIMUM DRAIN CURRENT vs CASE TEMPERATURE

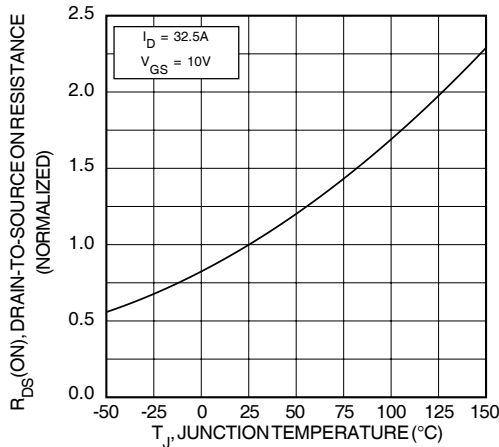

FIGURE 8, ON-RESISTANCE vs. TEMPERATURE

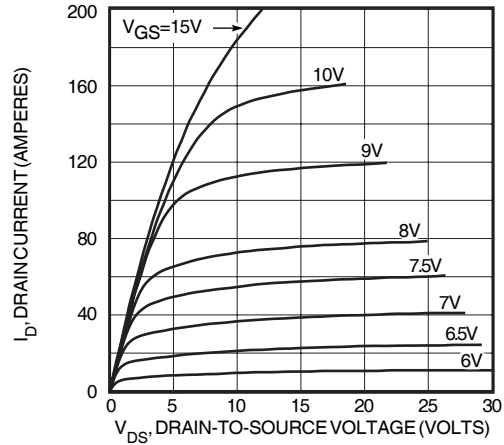

FIGURE 3, LOW VOLTAGE OUTPUT CHARACTERISTICS

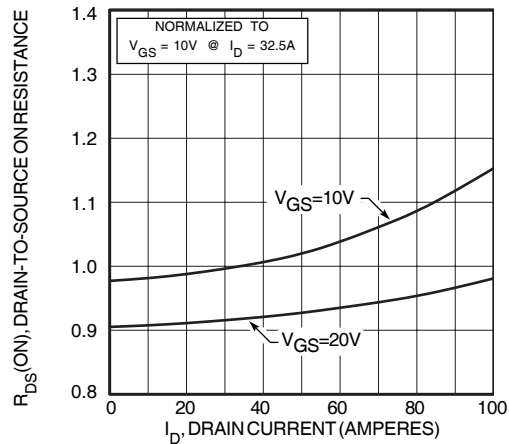

FIGURE 5,  $R_{DS(ON)}$  vs DRAIN CURRENT

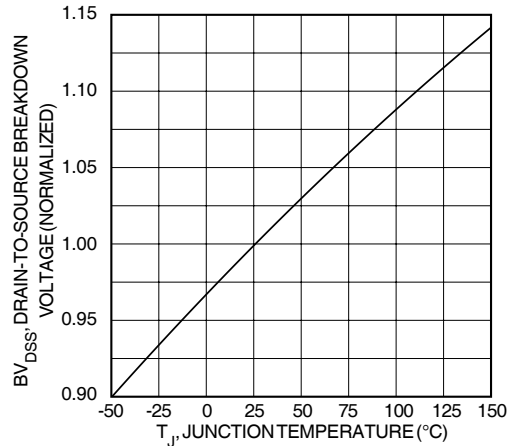

FIGURE 7, BREAKDOWN VOLTAGE vs TEMPERATURE

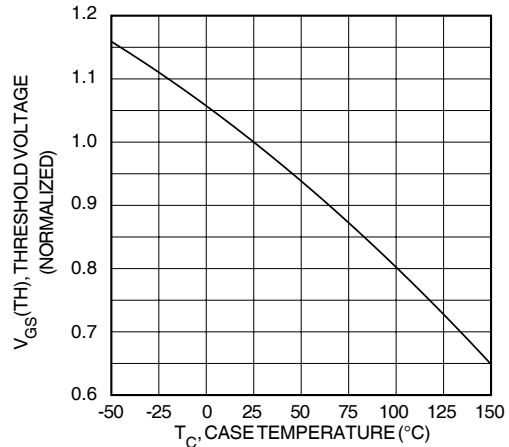

FIGURE 9, THRESHOLD VOLTAGE vs TEMPERATURE

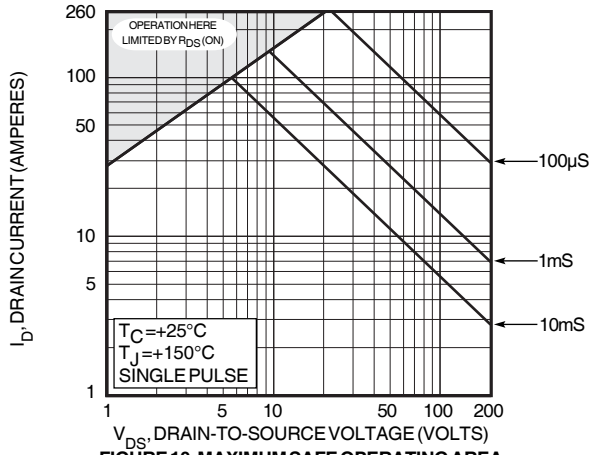

FIGURE 10, MAXIMUM SAFE OPERATING AREA

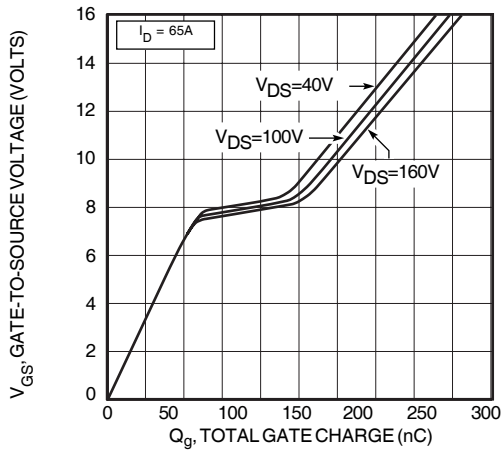

FIGURE 12, GATE CHARGES vs GATE-TO-SOURCE VOLTAGE

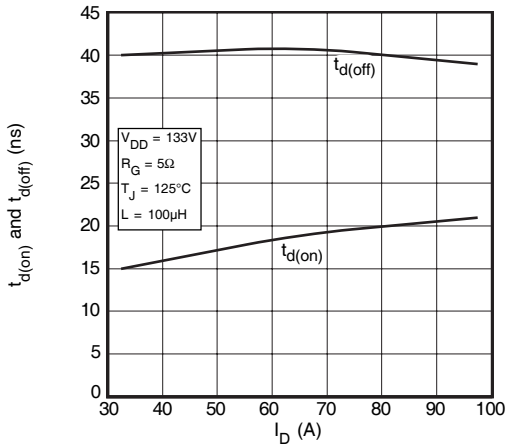

FIGURE 14, DELAY TIMES vs CURRENT

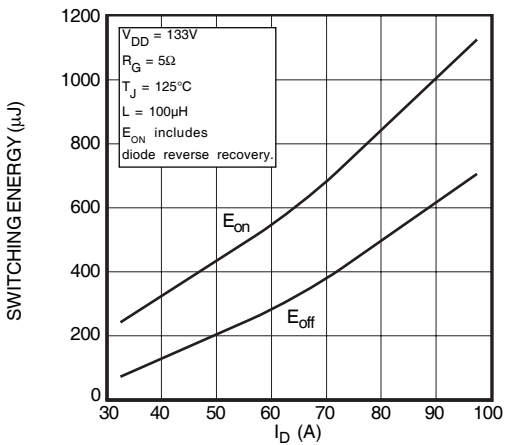

FIGURE 16, SWITCHING ENERGY vs CURRENT

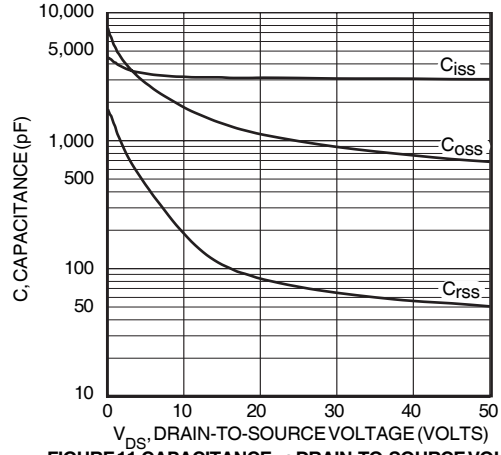

FIGURE 11, CAPACITANCE vs DRAIN-TO-SOURCE VOLTAGE

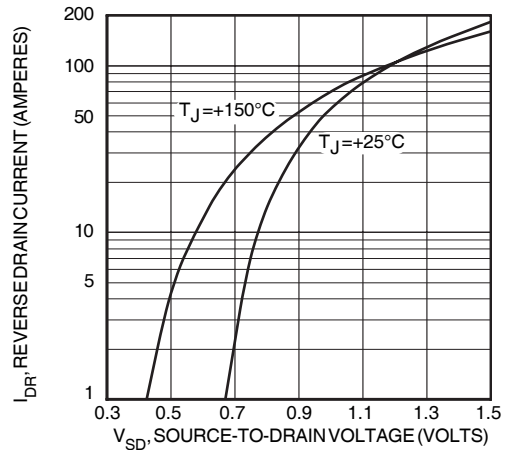

FIGURE 13, SOURCE-DRAIN DIODE FORWARD VOLTAGE

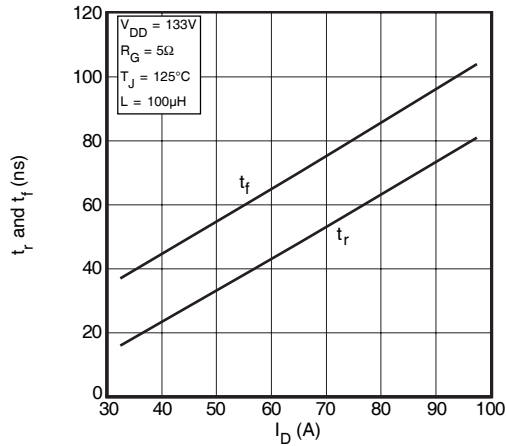

FIGURE 15, RISE AND FALL TIMES vs CURRENT

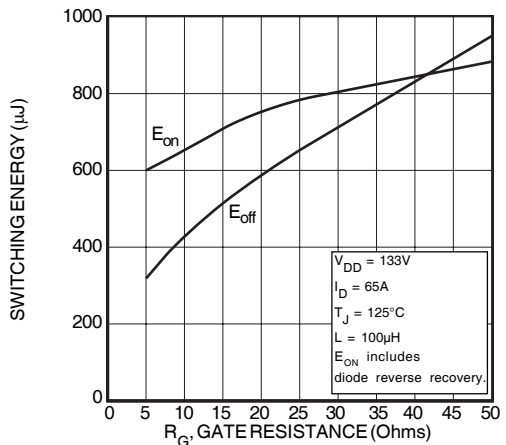

FIGURE 17, SWITCHING ENERGY vs. GATE RESISTANCE

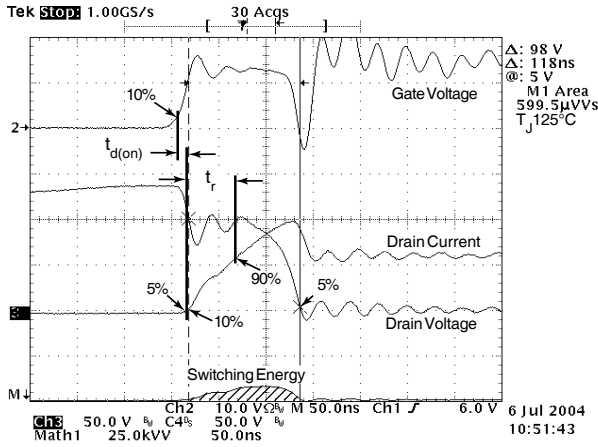

Figure 18, Turn-on Switching Waveforms and Definitions

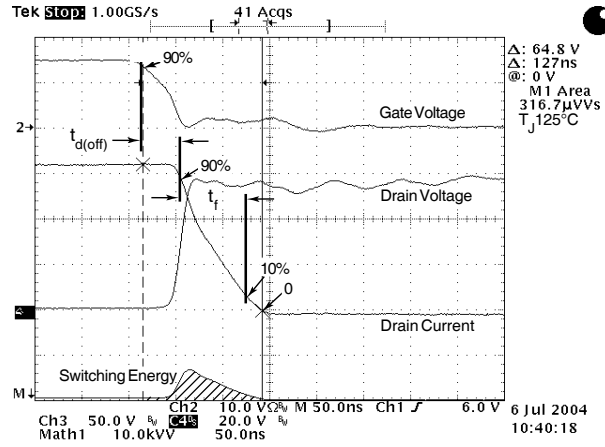

Figure 19, Turn-off Switching Waveforms and Definitions

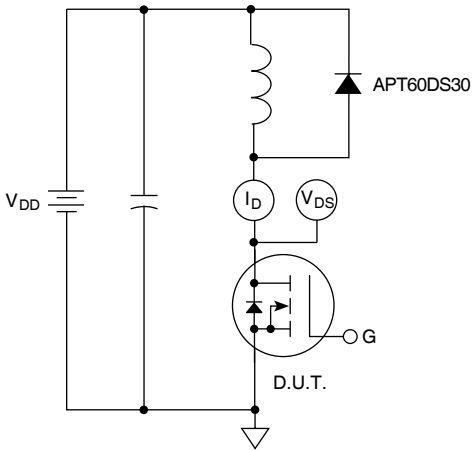
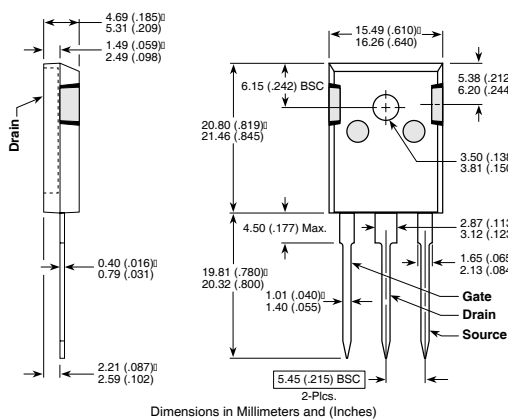
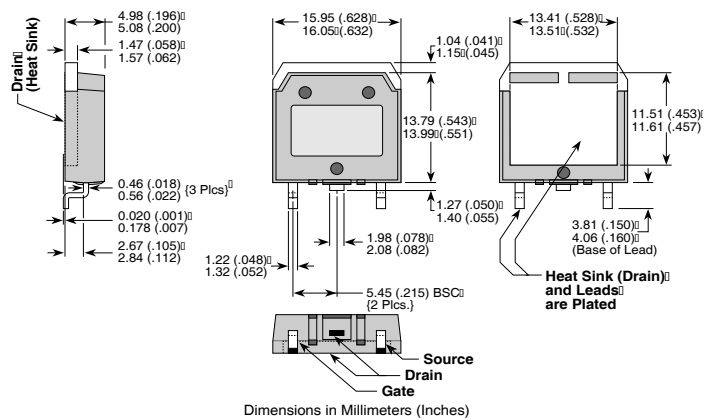

Figure 20, Inductive Switching Test Circuit

TO-247 Package Outline



D<sup>3</sup>PAK Package Outline



APT's products are covered by one or more of U.S. patents 4,895,810 5,045,903 5,089,434 5,182,234 5,019,522 5,262,336 6,503,786 5,256,583 4,748,103 5,283,202 5,231,474 5,434,095 5,528,058 and foreign patents. US and Foreign patents pending. All Rights Reserved.