

POWER MOS V®

Power MOS V® is a new generation of high voltage N-Channel enhancement mode power MOSFETs. This new technology minimizes the JFET effect, increases packing density and reduces the on-resistance. Power MOS V® also achieves faster switching speeds through optimized gate layout.

- **Faster Switching**
- **Avalanche Energy Rated**
- **Lower Leakage**
- **TO-264 MAX**

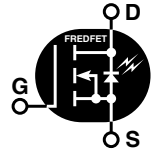
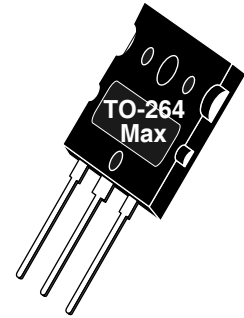

MAXIMUM RATINGS

All Ratings: $T_C = 25^\circ\text{C}$ unless otherwise specified.

Symbol	Parameter	APT12045L2VFR	UNIT
V_{DSS}	Drain-Source Voltage	1200	Volts
I_D	Continuous Drain Current @ $T_C = 25^\circ\text{C}$	28	Amps
I_{DM}	Pulsed Drain Current ^①	112	
V_{GS}	Gate-Source Voltage Continuous	± 30	Volts
V_{GSM}	Gate-Source Voltage Transient	± 40	
P_D	Total Power Dissipation @ $T_C = 25^\circ\text{C}$	833	Watts
	Linear Derating Factor	6.67	W/ $^\circ\text{C}$
T_J, T_{STG}	Operating and Storage Junction Temperature Range	-55 to 150	$^\circ\text{C}$
T_L	Lead Temperature: 0.063" from Case for 10 Sec.	300	
I_{AR}	Avalanche Current ^③ (Repetitive and Non-Repetitive)	28	Amps
E_{AR}	Repetitive Avalanche Energy ^③	50	mJ
E_{AS}	Single Pulse Avalanche Energy ^④	3200	

STATIC ELECTRICAL CHARACTERISTICS

Symbol	Characteristic / Test Conditions	MIN	TYP	MAX	UNIT
BV_{DSS}	Drain-Source Breakdown Voltage ($V_{GS} = 0V, I_D = 250\mu\text{A}$)	1200			Volts
$R_{DS(on)}$	Drain-Source On-State Resistance ^② ($V_{GS} = 10V, I_D = 14A$)			0.450	Ohms
I_{DSS}	Zero Gate Voltage Drain Current ($V_{DS} = 1200V, V_{GS} = 0V$)			250	μA
	Zero Gate Voltage Drain Current ($V_{DS} = 960V, V_{GS} = 0V, T_C = 125^\circ\text{C}$)			1000	
I_{GSS}	Gate-Source Leakage Current ($V_{GS} = \pm 30V, V_{DS} = 0V$)			± 100	nA
$V_{GS(th)}$	Gate Threshold Voltage ($V_{DS} = V_{GS}, I_D = 5mA$)	2		4	Volts

 **CAUTION:** These Devices are Sensitive to Electrostatic Discharge. Proper Handling Procedures Should Be Followed.

APT Website - <http://www.advancedpower.com>

DYNAMIC CHARACTERISTICS

APT12045L2VFR

Symbol	Characteristic	Test Conditions	MIN	TYP	MAX	UNIT
C _{iss}	Input Capacitance	V _{GS} = 0V		11370		pF
C _{oss}	Output Capacitance	V _{DS} = 25V		950		
C _{rss}	Reverse Transfer Capacitance	f = 1 MHz		495		
Q _g	Total Gate Charge ^③	V _{GS} = 10V		605		nC
Q _{gs}	Gate-Source Charge	V _{DD} = 600V		42		
Q _{gd}	Gate-Drain ("Miller") Charge	I _D = 28A @ 25°C		310		
t _{d(on)}	Turn-on Delay Time	V _{GS} = 15V		16		ns
t _r	Rise Time	V _{DD} = 600V		15		
t _{d(off)}	Turn-off Delay Time	I _D = 28A @ 25°C		85		
t _f	Fall Time	R _G = 0.6Ω		14		

SOURCE-DRAIN DIODE RATINGS AND CHARACTERISTICS

Symbol	Characteristic / Test Conditions	MIN	TYP	MAX	UNIT
I _S	Continuous Source Current (Body Diode)			28	Amps
I _{SM}	Pulsed Source Current ^① (Body Diode)			112	
V _{SD}	Diode Forward Voltage ^② (V _{GS} = 0V, I _S = -I _D 28A)			1.3	Volts
dv/dt	Peak Diode Recovery dv/dt ^⑤			18	V/ns
t _{rr}	Reverse Recovery Time (I _S = -I _D 28A, di/dt = 100A/μs)	T _j = 25°C		310	ns
		T _j = 125°C		625	
Q _{rr}	Reverse Recovery Charge (I _S = -I _D 28A, di/dt = 100A/μs)	T _j = 25°C		2	μC
		T _j = 125°C		6	
I _{FRM}	Peak Recovery Current (I _S = -I _D 28A, di/dt = 100A/μs)	T _j = 25°C		14	Amps
		T _j = 125°C		24	

THERMAL CHARACTERISTICS

Symbol	Characteristic	MIN	TYP	MAX	UNIT
R _{θJC}	Junction to Case			0.15	°C/W
R _{θJA}	Junction to Ambient			40	

- ① Repetitive Rating: Pulse width limited by maximum junction temperature.
 - ② Pulse Test: Pulse width < 380 μs, Duty Cycle < 2%
 - ③ See MIL-STD-750 Method 3471
 - ④ Starting T_j = +25°C, L = 8.16mH, R_G = 25Ω, Peak I_L = 28A
 - ⑤ I_S ≤ I_D [Cont.], di/dt = 100A/μs, T_j ≤ 150°C, R_G = 2.0Ω V_R = 200V.
- APT Reserves the right to change, without notice, the specifications and information contained herein.**

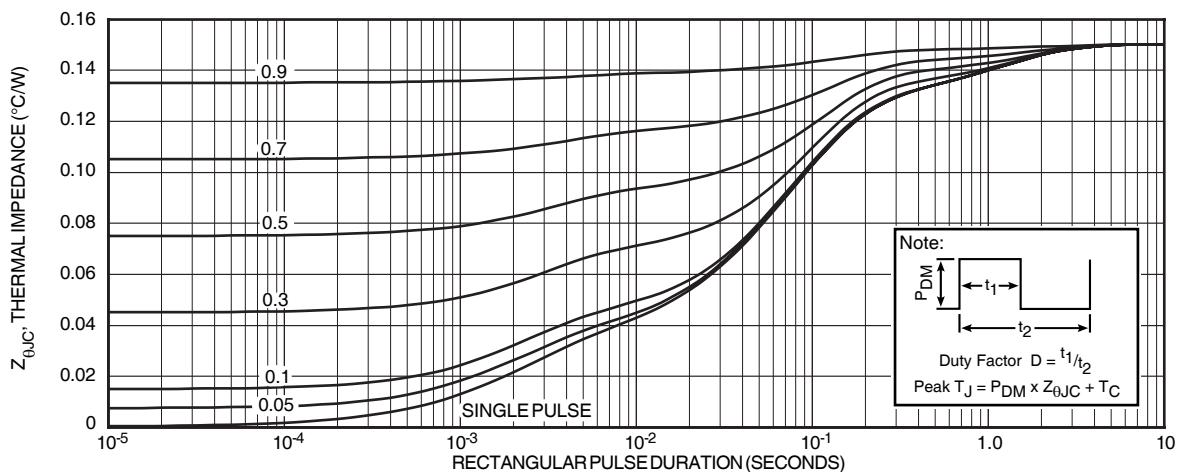

FIGURE 1, MAXIMUM EFFECTIVE TRANSIENT THERMAL IMPEDANCE, JUNCTION-TO-CASE vs PULSE DURATION

Typical Performance Curves

APT12045L2VFR

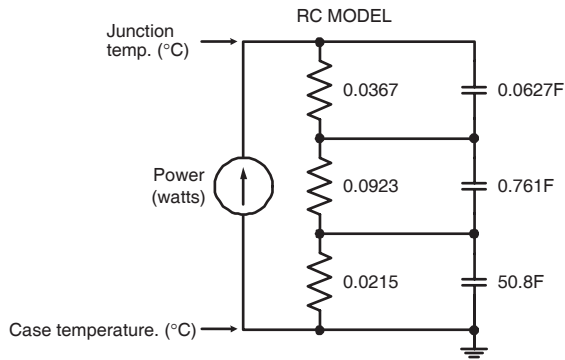

FIGURE 2, TRANSIENT THERMAL IMPEDANCE MODEL

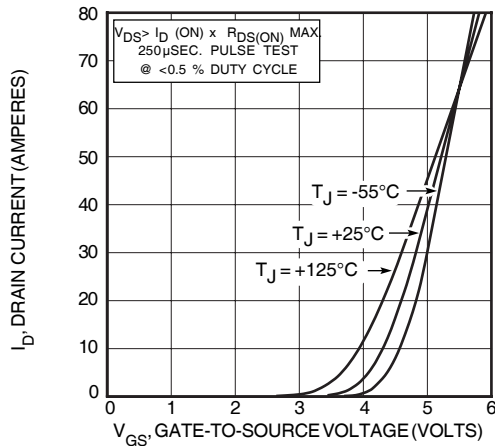

FIGURE 4, TRANSFER CHARACTERISTICS

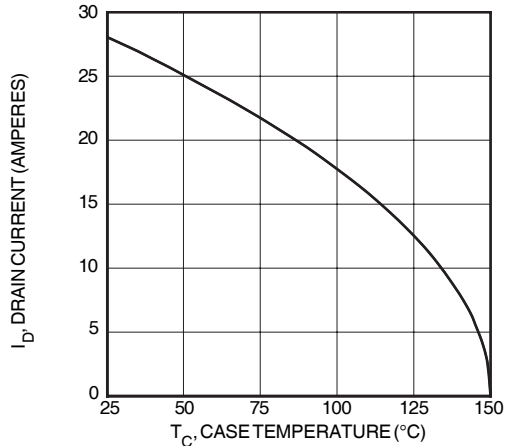

FIGURE 6, MAXIMUM DRAIN CURRENT vs CASE TEMPERATURE

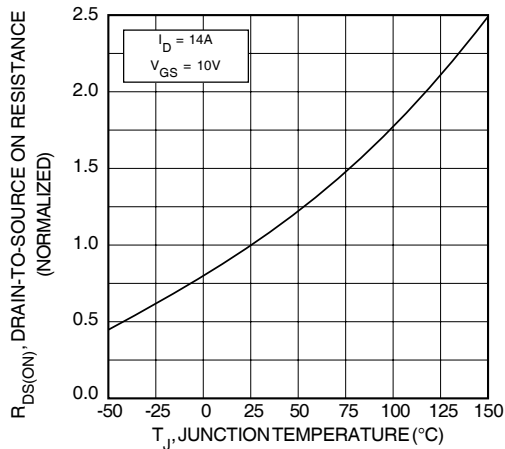

FIGURE 8, $R_{DS(ON)}$ vs. TEMPERATURE

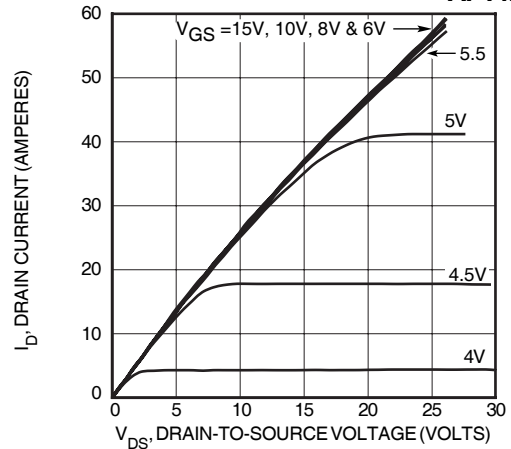

FIGURE 3, LOW VOLTAGE OUTPUT CHARACTERISTICS

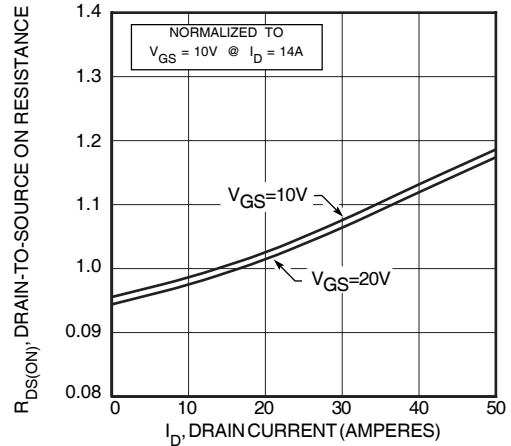

FIGURE 5, $R_{DS(ON)}$ vs DRAIN CURRENT

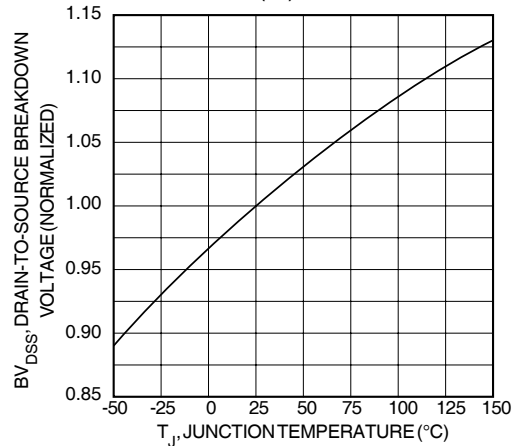

FIGURE 7, BREAKDOWN VOLTAGE vs TEMPERATURE

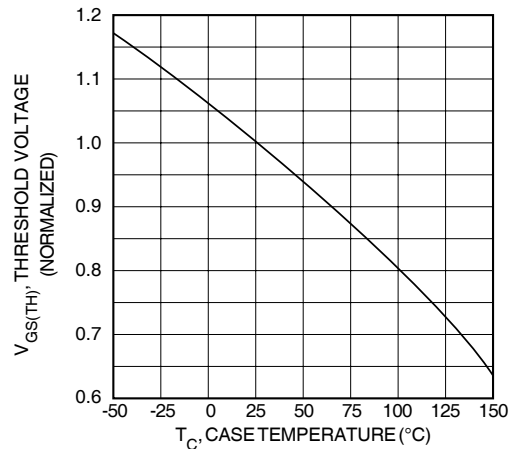

FIGURE 9, THRESHOLD VOLTAGE vs TEMPERATURE

Typical Performance Curves

APT12045L2VFR

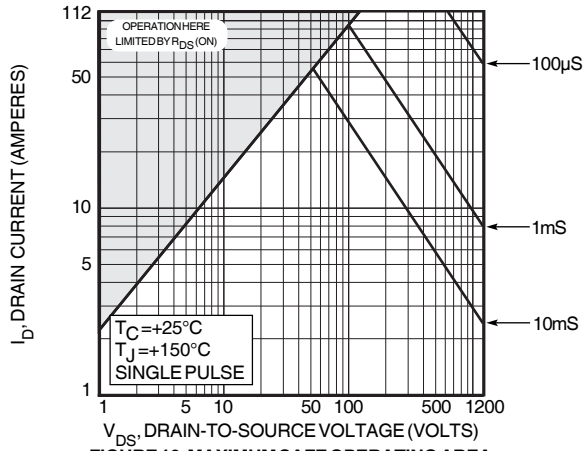

FIGURE 10, MAXIMUM SAFE OPERATING AREA

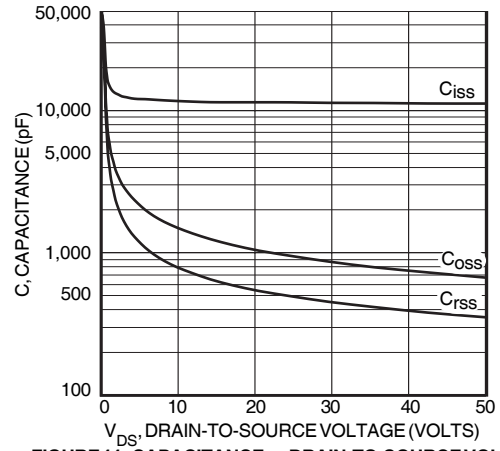

FIGURE 11, CAPACITANCE vs DRAIN-TO-SOURCE VOLTAGE

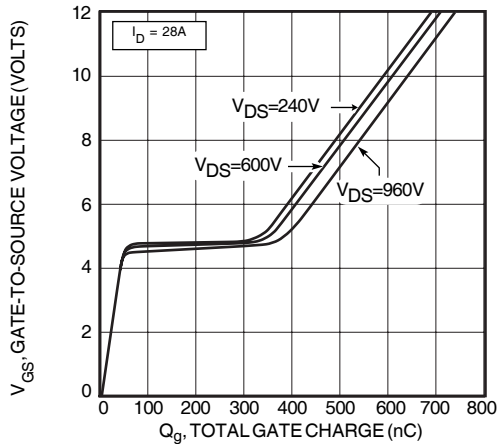

FIGURE 12, GATE CHARGE vs GATE-TO-SOURCE VOLTAGE

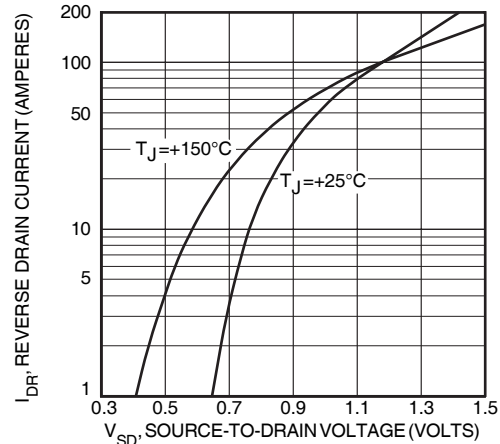
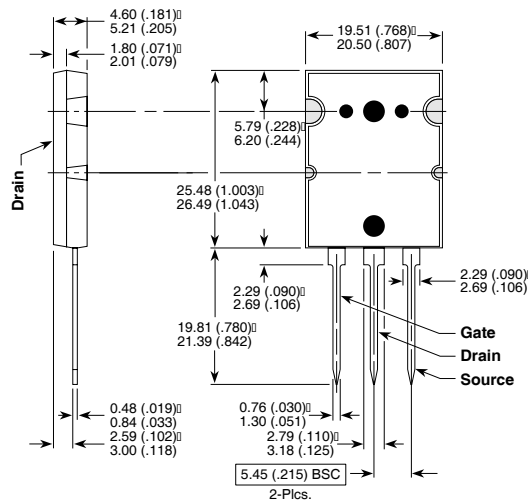

FIGURE 13, SOURCE-DRAIN DIODE FORWARD VOLTAGE

TO-264 MAX™(L2) Package Outline



Dimensions in Millimeters and (Inches)

APT's products are covered by one or more of U.S. patents 4,895,810 5,045,903 5,089,434 5,182,234 5,019,522 5,262,336 6,503,786 5,256,583 4,748,103 5,283,202 5,231,474 5,434,095 5,528,058 and foreign patents. US and Foreign patents pending. All Rights Reserved.