

High Voltage BIMOSFET™ Monolithic Bipolar MOS Transistor

N-Channel, Enhancement Mode
MOSFET compatible

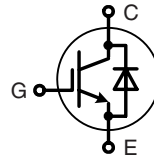

$I_{C25} = 9 \text{ A}$
 $V_{CES} = 1600 \text{ V}$
 $V_{CE(sat)} = 4.9 \text{ V typ.}$
 $t_{fi} = 70 \text{ ns}$

TO-247 AD

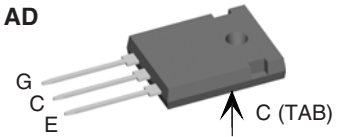

G = Gate,
E = Emitter, C = Collector,
TAB = Collector

Symbol	Conditions	Maximum Ratings	
V_{CES}	$T_J = 25^\circ\text{C to } 150^\circ\text{C}$	1600	V
V_{CGR}	$T_J = 25^\circ\text{C to } 150^\circ\text{C}; R_{GE} = 1 \text{ M}\Omega$	1600	V
V_{GES}	Continuous	± 20	V
V_{GEM}	Transient	± 30	V
I_{C25}	$T_C = 25^\circ\text{C}$	9	A
I_{C90}	$T_C = 90^\circ\text{C}$	5	A
I_{CM}	$T_C = 25^\circ\text{C}, 1 \text{ ms}$	10	A
SSOA (RBSOA)	$V_{GE} = 10 \text{ V}, T_{VJ} = 125^\circ\text{C}, R_G = 27 \Omega, V_{CE} = 0.8 \cdot V_{CES}$ Clamped inductive load, $L = 100 \mu\text{H}$	$I_{CM} = 12$	A
P_c	$T_C = 25^\circ\text{C}$	100	W
T_J		-55 ... +150	$^\circ\text{C}$
T_{JM}		150	$^\circ\text{C}$
T_{stg}		-55 ... +150	$^\circ\text{C}$
T_L	1.6 mm (0.063 in) from case for 10 s	300	$^\circ\text{C}$
M_d	Mounting torque	1.15	Nm
Weight		6	g

Features

- High Voltage BIMOSFET™
 - replaces high voltage Darlington's and series connected MOSFET's
 - lower effective $R_{DS(on)}$
- MOS Gate turn-on
 - drive simplicity
 - MOSFET compatible for 10V turn on gate voltage
- Monolithic construction
 - high blocking voltage capability
 - very fast turn-off characteristics
- International standard package JEDEC TO-247 AD
- Reverse conducting capability

Applications

- Flyback converters
- DC choppers
- Uninterruptible power supplies (UPS)
- Switched-mode and resonant-mode power supplies
- CRT deflection
- Lamp ballasts

Advantages

- Easy to mount with 1 screw (isolated mounting screw hole)
- Space savings
- High power density

Symbol	Conditions	Characteristic Values ($T_J = 25^\circ\text{C}$, unless otherwise specified)		
		min.	typ.	max.
BV_{CES}	$I_C = 0.25 \text{ mA}, V_{GE} = 0 \text{ V}$	1600		V
$V_{GE(th)}$	$I_C = 0.5 \text{ mA}, V_{CE} = V_{GE}$	3.5		5.5 V
I_{CES}	$V_{CE} = 0.8 \cdot V_{CES}$ $V_{GE} = 0 \text{ V}$	$T_J = 25^\circ\text{C}$ $T_J = 125^\circ\text{C}$	0.1	100 μA mA
I_{GES}	$V_{CE} = 0 \text{ V}, V_{GE} = \pm 20 \text{ V}$			$\pm 500 \text{ nA}$
$V_{CE(sat)}$	$I_C = I_{C90}, V_{GE} = 15 \text{ V}$ $T_J = 125^\circ\text{C}$		4.9 5.6	7 V V

Symbol	Conditions	Characteristic Values		
		(T _J = 25°C, unless otherwise specified)		
		min.	typ.	max.
C _{ies}	V _{CE} = 25 V, V _{GE} = 0 V, f = 1 MHz		550	pF
C _{oes}			36	pF
C _{res}			5	pF
Q _g	I _C = 5 A, V _{CE} = 600 V, V _{GE} = 10 V	34		nC
t _{d(on)}	Inductive load, T _J = 125°C I _C = I _{C90} , V _{GE} = 10 V, L = 100 μH, V _{CE} = 960 V, R _G = 27 Ω		140	ns
t _{ri}			200	ns
t _{d(off)}			120	ns
t _{fi}			70	ns
R _{thJC}			1.25	K/W
R _{thCK}		0.25		K/W

Symbol	Conditions	Characteristic Values		
		(T _J = 25°C, unless otherwise specified)		
		min.	typ.	max.
V _F	I _F = I _{C90} , V _{GE} = 0 V		3.6	5

TO-247 AD Outline

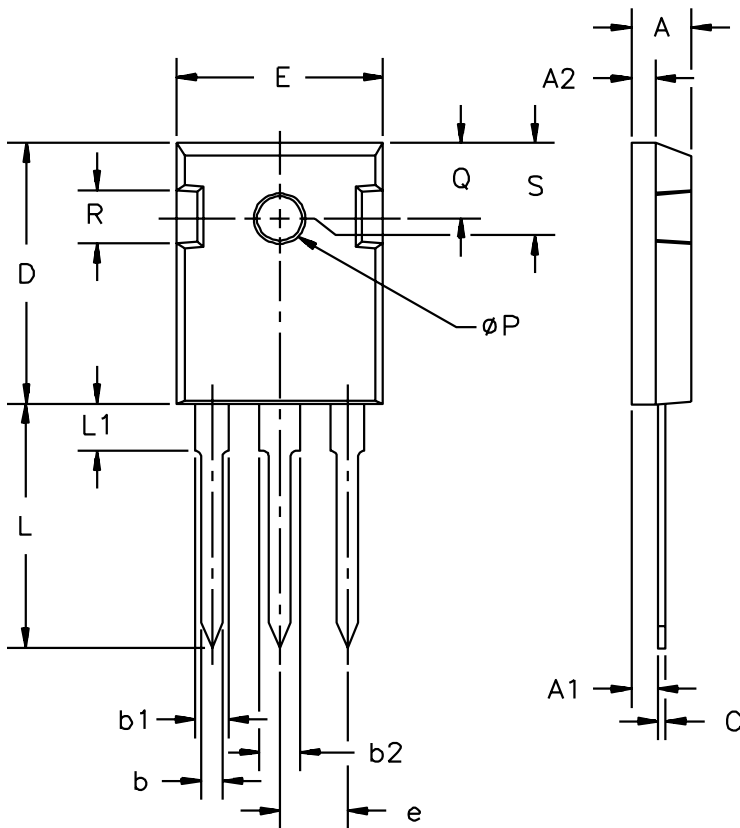

Dim.	Millimeter		Inches	
	Min.	Max.	Min.	Max.
A	19.81	20.32	0.780	0.800
B	20.80	21.46	0.819	0.845
C	15.75	16.26	0.610	0.640
D	3.55	3.65	0.140	0.144
E	4.32	5.49	0.170	0.216
F	5.4	6.2	0.212	0.244
G	1.65	2.13	0.065	0.084
H	-	4.5	-	0.177
J	1.0	1.4	0.040	0.055
K	10.8	11.0	0.426	0.433
L	4.7	5.3	0.185	0.209
M	0.4	0.8	0.016	0.031
N	1.5	2.49	0.087	0.102

IXYS reserves the right to change limits, test conditions and dimensions.

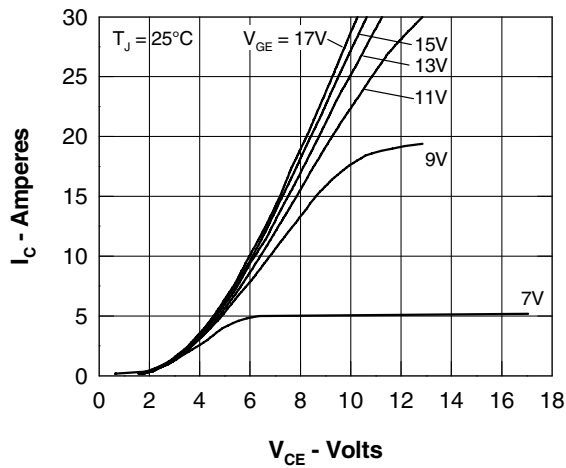

Fig. 1 Typ. Output Characteristics

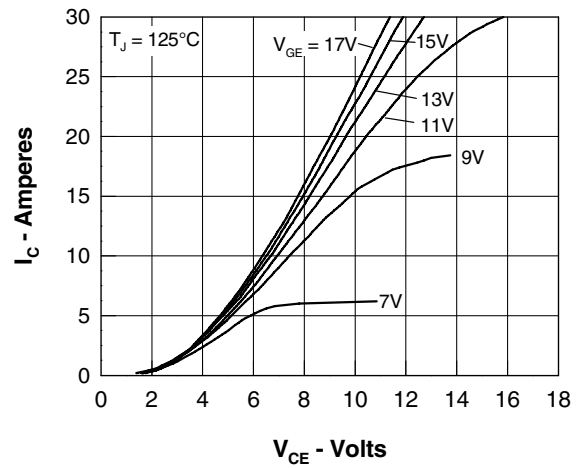

Fig. 2 Typ. Output Characteristics

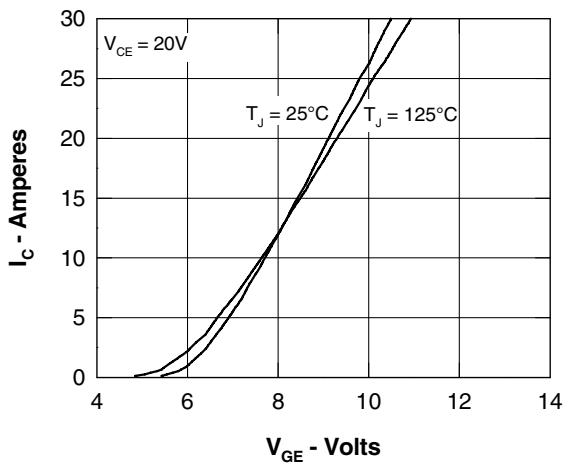

Fig. 3 Typ. Transfer Characteristics

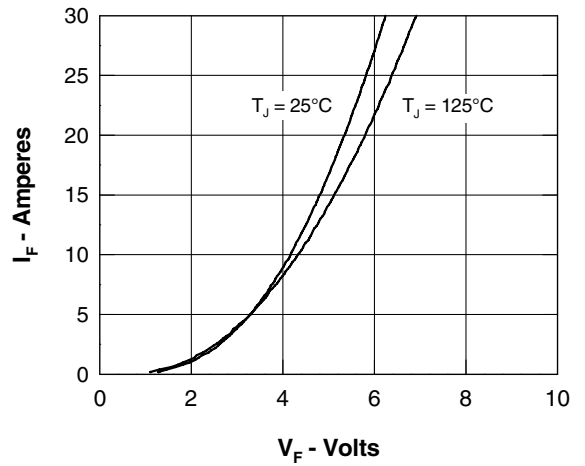

Fig. 4 Typ. Characteristics of Reverse Conduction

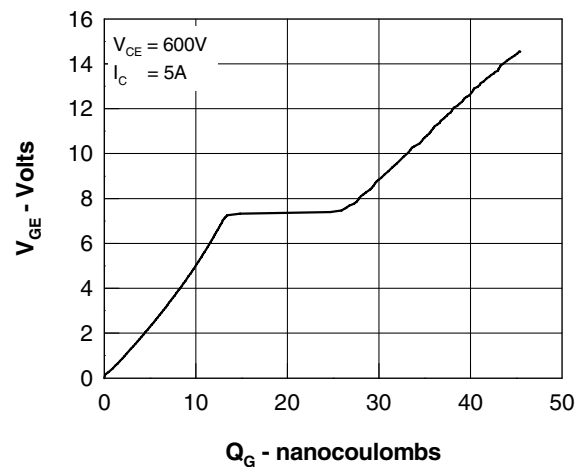

Fig. 5 Typ. Gate Charge characteristics

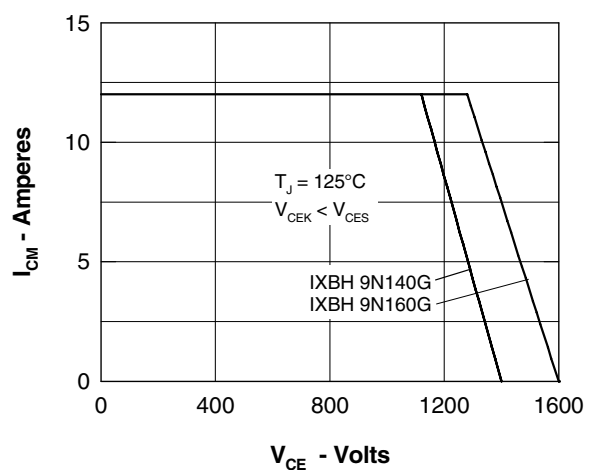

Fig. 6 Reverse Biased Safe Operating Area RBSOA

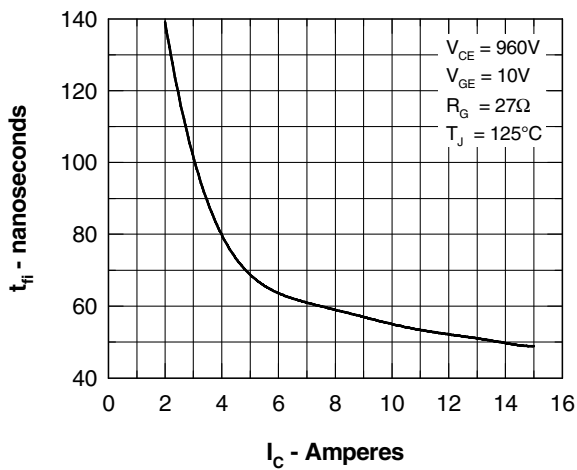

Fig. 7 Typ. Fall Time

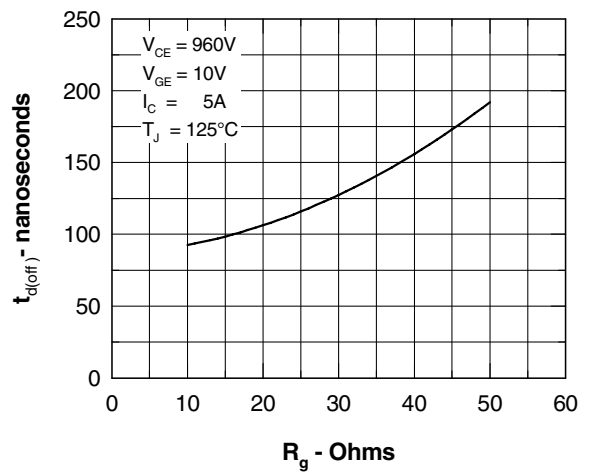

Fig. 8 Typ. Turn Off Delay Time

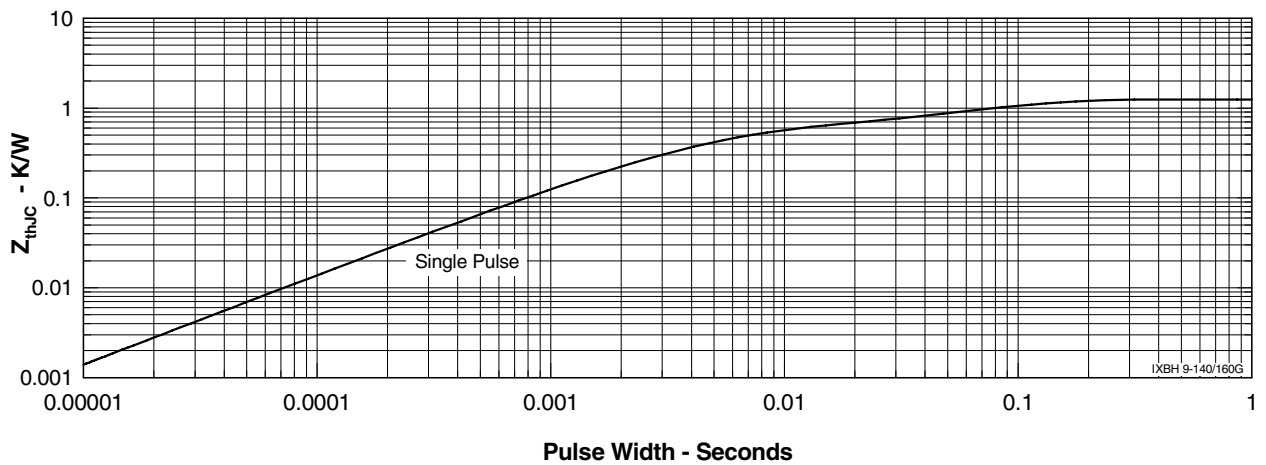

Fig. 9 Typ. Transient Thermal Impedance